

# **Using Flow Cost for MANET Routing**

By

Junxiao He

Thesis submitted to the University of Ottawa  
in partial fulfillment of requirements for the degree of

**Doctor of Philosophy**

School of Electrical and Computer Engineering  
Faculty of Engineering  
University of Ottawa

© Junxiao He, Ottawa, Canada, 2020

## **Abstract**

This thesis has introduced the concept of Flow Cost (FC) that can capture many metrics of interest, but not just the shortest distance or smallest delay as done in many traditional algorithms. It allows us to capture the influence of flows from other parts of the network through their interaction at a given node. We first proposed the routing algorithm called GANFA in static mobile ad hoc networks where FC is formulated as a function of node power, link delay and hop count (and later, queueing delay). The FC also allows us to choose the best path through optimization, and to provide bandwidth allocation. We have further extended our study to the dynamic mobile ad hoc network by proposing the FC-AOMDV multipath routing algorithm which prepares a back-up alternate path at the same time when the primary route is set up. A comparison of video application between the FC-AOMDV and the AODV is done to prove the performance improvement. With the consideration of real-time transmission, a predictive real-time approach named RPET-FC-AOMDV is designed that studied the influence of both the node speed and node density. Besides applying FC in 2D network routing, we have also used it to design the FC-3DGR for AANET application in which we have explored the localization and high-speed issues in 3D MAENTs. Unlike using distance as the only criterion in greedy protocol, our FC accounts for both distance and number of neighbors for routing path selection. In this way, we can avoid some problems such as VNP (Void Node Problem) encountered in other greedy routing study.

## Acknowledgement

First, I would like to express my greatest gratitude to Prof. Oliver Yang, my thesis supervisor, for his invaluable and tireless guidance throughout my Ph.D. research. His great intuition, profound knowledge, remarkable research expertise and inspiring comments demonstrated to me the dedication, hard work that were needed to do my thesis, and eventually enabled me to finish it successfully. He is not only a supervisor but also a role model and a friend of mine.

I also owe a great debt of thanks to my family. I thank my husband's constant support, understanding, encouragement and love throughout these years. When I came across difficulties in the research, the sweet smiles of my two daughters gave me encouragement and reenergized me. I am also deeply appreciated by the love and support from my parents. Without their help for taking care of my kids, it would have been difficult indeed for me to complete a Ph.D. To them I owe my deepest gratitude.

Many thanks go to the members of the CCNR (Computer Communication Network Research) Laboratory for their help and unforgettably nice time being together. Moreover, I would like to give my sincere thanks to Dr. Yifeng Zhou of the CRC (Communication Research Center) for his significant suggestions and help during the first stage of my research.

Finally, this work was partially supported by a CRC (Communication Research Center) contract and an OGS (Ontario Graduate Scholarship) scholarship.

# Table of Contents

<b>Title.....</b>	<b>i</b>
<b>Abstract.....</b>	<b>ii</b>
<b>Acknowledgement.....</b>	<b>iii</b>
<b>Table of Contents.....</b>	<b>iv</b>
<b>List of Figures.....</b>	<b>viii</b>
<b>List of Tables.....</b>	<b>x</b>
<b>Table of Acronyms and Abbreviations.....</b>	<b>xi</b>
<b>Table of Symbols.....</b>	<b>xiv</b>
<b>Chapter 1 Introduction.....</b>	<b>1</b>
1.1 Overview of MANETs.....	2
1.1.1 Historical Development.....	3
1.1.2 Features and Challenges.....	4
1.1.3 Applications.....	5
1.2 MANET Routing Protocols.....	6
1.2.1 Unipath Routing.....	7
1.2.2 Multipath Routing.....	8
1.2.2.1 Background.....	8
1.2.2.2 Components.....	9
1.2.2.3 Advantages and Disadvantages.....	10
1.2.2.4 Subclassification.....	13
1.2.3 3D Routing.....	18
1.2.3.1 UWSN Routing.....	18
1.2.3.2 AANET Routing.....	19
1.2.3.3 Challenges of 3D Networks.....	20
1.3 Limited Bandwidth Allocation.....	21
1.4 Optimization.....	23
1.4.1 General Optimization.....	23
1.4.2 Optimization in MANET.....	24
1.5 Motivation.....	25
1.6 Objectives.....	26
1.7 Methodology and Approaches.....	27

1.8	Contributions .....	29
1.9	Thesis Organization.....	30
1.10	Publications .....	30
<b>Chapter 2 Network Operation, Modeling and Assumptions .....</b>		<b>32</b>
2.1	Wireless Network Model .....	32
2.1.1	Static Ad Hoc Network Model.....	32
2.1.2	Dynamic Mobile Ad Hoc Network Model.....	34
2.1.3	3D Network Model.....	34
2.2	Multipath Routing Process .....	35
2.3	OPNET Models .....	39
2.3.1	Static Network Model .....	39
2.3.2	Dynamic Network Model.....	41
2.4	Performance Measures Definition.....	43
2.5	Assumptions .....	44
<b>Chapter 3 GANFA Based on Multipath Routing in Static MANETs.....</b>		<b>46</b>
3.1	The GANFA Algorithm .....	46
3.1.1	Flow Cost for Path Ranking.....	47
3.1.2	Crowded Node .....	48
3.1.3	The Optimization Problem Formulation.....	49
3.1.4	The GANFA Algorithm Design.....	50
3.1.5	Example .....	51
3.2	Optimization Performance of GANFA .....	52
3.3	The Improved GANFA Algorithm.....	56
3.3.1	The Updated Flow Cost Calculation.....	57
3.3.2	Node-disjoint Routing Path Selection.....	57
3.3.3	The Updated Optimization Formulation.....	59
3.3.4	The Updated Algorithm Design.....	61
3.4	Optimization Performance Evaluation .....	61
3.4.1	Two Multiple Paths.....	62
3.4.2	More than Two Multiple Paths .....	68
3.4.3	Comparison of the Two Algorithms .....	70
3.5	Performance Comparison in OPNET.....	71
3.5.1	Simulation Implementation.....	71

3.5.2	Performance Results Analysis .....	72
3.6	Concluding Remarks.....	75
<b>Chapter 4 AOMDV Routing based on the FC in Dynamic MANET.....</b>		<b>76</b>
4.1	AODV and AOMDV .....	76
4.2	Design of FC-AOMDV .....	78
4.3	Performance Evaluations.....	78
4.3.1	A Small Network.....	79
4.3.1.1	End-to-end Delay .....	79
4.3.1.2	Throughput .....	81
4.3.1.3	Packet Delivery Ratio.....	81
4.3.1.4	Steady State Performance.....	82
4.3.2	A Large Network.....	84
4.3.2.1	End-to-end Delay .....	86
4.3.2.2	Throughput.....	87
4.3.2.3	Packet Delivery Ratio.....	87
4.4	Video Application and Its Performance Evaluation.....	88
4.5	Concluding Remarks .....	92
<b>Chapter 5 Predictive Real-time FC-AOMDV Routing Algorithm.....</b>		<b>94</b>
5.1	Design Principle .....	94
5.2	Empirical Design of RPET-FC-AOMDV .....	95
5.2.1	RPET as a Function of Node Speeds .....	96
5.2.2	RPET as a Function of Node Density .....	97
5.2.3	RPET Formulation .....	99
5.3	Performance Evaluation and Comparison.....	100
5.4	Concluding Remarks .....	105
<b>Chapter 6 Routing Protocol in 3D MANETs .....</b>		<b>107</b>
6.1	Design Consideration for 3D Routing.....	107
6.2	3D Routing Protocol.....	108
6.2.1	Neighbor Discovery .....	109
6.2.2	Greedy Routing .....	109
6.2.3	Shortcomings of Greedy Routing.....	110
6.2.3.1	Void Node Problem.....	110

6.2.3.2	Equal Distance Problem .....	111
6.2.4	3D Greedy Routing Design based on Flow Cost .....	112
6.2.4.1	Example.....	113
6.3	Performance Evaluation .....	114
6.4	Concluding Remarks .....	119
<b>Chapter 7 Conclusion and Future Work .....</b>		<b>121</b>
7.1	Future Work .....	122
<b>References .....</b>		<b>124</b>
<b>Appendix.....</b>		<b>135</b>

## List of Figures

Fig.1-1	Network based on an Infrastructure	1
Fig.1-2	Mobile Ad hoc Network	2
Fig.1-3	Classification of MANET Routing Protocols	6
Fig.2-1	The Static Ad hoc Network Model	33
Fig.2-2	Example Network for Route Discovery	36
Fig.2-3	OPNET Model for a Static Network	39
Fig.2-4	Node Attributes in the Network Model	40
Fig.2-5	Dynamic Network Model in OPNET	41
Fig.2-6	Mobility Configuration Attributes	42
Fig.3-1	A Small Network Example with 2 Pairs' Transmission	51
Fig.3-2	Topology after Network Flow Assignment	54
Fig.3-3	Optimization Model Information	55
Fig.3-4	Optimization Result	55
Fig.3-5	A 20-Nodes Network Example	62
Fig.3-6	Optimal Allocation Result for Two Paths	64
Fig.3-7	Relationship between FC and Bandwidth	66
Fig.3-8	TotalFlowCost of All Paths vs Cost Assignment of One Path	66
Fig.3-9	Relationship between FC and Utilization in CN5	67
Fig.3-10	Relationship between FC and Utilization in CN8	67
Fig.3-11	Bandwidth Allocation Result for 3 Multiple Routing Paths	69
Fig.3-12	Relationship between the Total Flow Cost with the Number of Paths P	70
Fig.3-13	Node Model	71
Fig.3-14	Throughput Comparison for Path from Source Node 1 to Destination node 9	73
Fig.3-15	Throughput Comparison for Source Node 7 to Destination Node 4	73
Fig.3-16	Throughput Comparison	74
Fig.4-1	End-to-End delay Comparison in Small Network	80
Fig.4-2	Throughput Comparison in Small Network	80
Fig.4-3	Packet Delivery Ratio Comparison in Small Network	81
Fig.4-4	End-to-End Delay with 95% Confidence Interval	82
Fig.4-5	End-to-End Delay Comparison with Different Node Speeds	83

Fig.4-6	Throughput Comparison with Different Node Speeds	83
Fig.4-7	PDR Comparison with Different Node Speeds	84
Fig.4-8	End-to-End Delay Comparison in Large Network	85
Fig.4-9	Throughput Comparison in Large Network	86
Fig.4-10	Packet Delivery Ratio Comparison in Large Network	87
Fig.4-11	Comparison of End-to-End Delay with Different Moving Speed	89
Fig.4-12	End-to-end Delay Comparison with Different Delay Weight in FC	90
Fig.4-13	Comparison of Throughput with Different Moving Speed	91
Fig.4-14	Comparison of Packet Delivery Ratio with Different Moving Speed	91
Fig.5-1	Converge Simulated Time	95
Fig.5-2	Mean Value for RPET vs Node Speed and Node Density	96
Fig.5-3	Mean Value of RPET for Different Node Density	98
Fig.5-4	Different Areas with Same Number of Nodes	98
Fig.5-5	Results with More Speeds used for Formulation	99
Fig.5-6	End-to-end Delay Comparison with Speed=10m/s	101
Fig.5-7	Throughput Comparison with Speed=10m/s	101
Fig.5-8	Packet Delivery Ratio Comparison with Speed=10m/s	102
Fig.5-9	Comparison for End-to-end Delay with Different Speeds	103
Fig.5-10	Comparison for Throughput with Different Speeds	104
Fig.5-11	Comparison for Packet Delivery Ratio with Different Speeds	105
Fig.6-1	Void Node Problem	110
Fig.6-2	Equal Distance Problem	111
Fig.6-3	Example of FC-3DGR	113
Fig.6-4	End-to-end Delay with Different Node Density	114
Fig.6-5	Throughput with Different Node Density	115
Fig.6-6	Packet Delivery Ratio with Different Node Density	116
Fig.6-7	End-to-End Delay with Different Node Speed	117
Fig.6-8	Throughput with Different Node Speed	118
Fig.6-9	Packet Delivery Ratio with Different Node Speed	119

## List of Tables

Table 3-1	Data Rate of Source Nodes	52
Table 3-2	Crowded Node Capacity	53
Table 3-3	Flow Cost	53
Table 3-4	Sample Data for 1st Transmission	62
Table 3-5	Sample Data for 2nd Transmission	63
Table 3-6	Other Random Allocation Schemes	65
Table 3-7	Information for Third Path	68
Table 3-8	Comparison of Two Algorithms	71
Table 4-1	Simulation Parameters of Small Network	79
Table 4-2	Simulation Parameters of Large Network	85
Table 5-1	Simulation Parameters	100

## Table of Acronyms and Abbreviations

		<b>Page of 1st Appearance</b>
AANET	Airborne Ad hoc Network	19
ACK	ACKnowledgement	18
ADS	Analytic Decision Support	52
AdamRTP	Adaptive Multi-flows Real-time Multimedia Transport Protocol	17
AIMMS	Advanced Integrated Multidimensional Modeling Software	28
ALOHA	Additive Links On-line Hawaii Area	3
AODV	Ad hoc On-demand Distance Vector	1
AOMDV	Ad hoc On-demand Multipath Distance Vector	10
ATM	Asynchronous Transfer Mode	9
BAN	Body Area Networks	6
CDMA	Code Division Multiple Access	21
CIF	Common Intermediate Format	88
CNs	Crowded Nodes	27
CSMA	Carrier Sense Medium Access	3
DARPA	Defense Advanced Research Projects Agency	3
DAMR	Delay Aware Multipath Routing	13
DBACA	Dynamic Bandwidth Allocation with Collision Avoidance	22
DES	Discrete Event Simulation	43
DOLSR	Directional Optimized Link State Routing	19
DSDV	Destination Sequenced Distance Vector	7
DSR	Dynamic Source Routing	1
EDP	Equal Distance Problem	30
EEMR	Energy Efficient Multipath Routing	14
ER	Epidemic Routing	18
FC	Flow Cost	27
FC-3DGR	3D Greedy Routing based on Flow Cost	112
FC-AOMDV	Ad hoc On-demand Multipath Distance Vector routing based on Flow Cost	29
FDMA	Frequency Division Multiple Access	21
FMRM	Fuzzy controllers based Multipath Routing in MANET	17
FT-SPEED	Fault-Tolerant real-time routing protocol	17

GAMR	Globally Aware Multipath Routing	15
GOR	Global On-demand Routing	16
GPMOR	Geographic Position Mobility Oriented Routing	19
GPS	Global Positioning System	34
GANFA	Globally Aware Network Flow Allocation	29
GloMo	Global Mobile Information System	3
HMR	Hybrid Multipath Routing	16
IETF	Internet Engineering Task Force	4
IEEE	Institute of Electrical and Electronics Engineers	4
LP	Linear Programming	24
MAC	Medium Access Control	21
MANET	Mobile Ad hoc Network	1
MIP	Mixed Integer Programming	24
MILP	Mixed-Integer Linear Program	24
MINLP	Mixed-Integer Non-Linear Program	24
MOMR	Minimum Overhead Multipath Routing	14
MP-DSR	MultiPath Dynamic Source Routing	11
MSR	Multipath Source Routing	9
NLP	Non-Linear Program	24
NOC	Network-On-Chip	16
NS-AOMDV	AOMDV based on the Node State	10
NTDR	Near Term Digital Radio	3
OLSR	Optimized Link State Routing	19
OSI	Open Systems Interconnection	135
PCMCIA	Personal Computer Memory Card International Association	4
QoS	Quality of Service	12
PRNET	Packet Radio Network	3
RAMR	Reliability Aware Multipath Routing	15
RPT	Routing Path Table	33
RPET	Routing Path Expiration Time	28
RPAR	Real-time Power-aware Routing	17
RERR	Route ERRor	36
RREQ	Route REQuest	34
RREP	Route REPlY	34

RWM	Random Waypoint Mobility	42
RTR	Real Time Routing	17
SMR	Split Multipath Routing	9
SURAN	Survivable Adaptive Radio Networks	3
TDMA	Time Division Multiple Access	21
TFC	Total Flow Cost	46
UDP	User Datagram Protocol	89
UWSN	Underwater Sensor Network	18
VNP	Void Node Problem	29
WLANs	Wireless Local Area Networks	4
WRP	Wireless Routing Protocol	7
ZHLS	Zone-based Hierarchical Link State	8
ZRP	Zone Routing Protocol	8

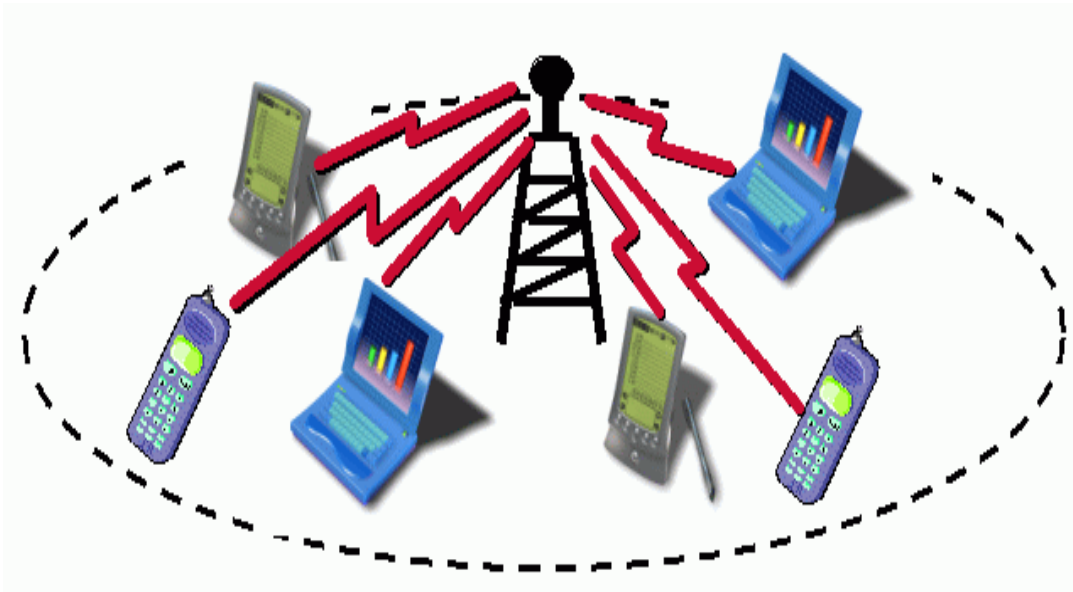
## Table of Symbols

		<b>Page of 1st Appearance</b>
$\alpha$	Weight factor for power.	57
$\beta$	Weight factor for delay.	57
$\gamma$	Weight factor for hop count.	57
$B_{vu}$	Bandwidth for the link from node $v$ to node $u$ .	33
$C_c$	Maximum capacity (bps) of node $C$ .	49
$C_{max}^c$	The maximum capacity of <i>crowded node C</i> .	59
$D_s$	Data rate from source node $S$ .	49
$D_{vu}$	Link delay a link from node $v$ to node $u$ .	33
$D_{max}$	Maximum delay of all links in the network.	33
$FC_i$	Flow Cost of the $i^{th}$ routing path.	47
$H_i$	Number of hops of the $i^{th}$ routing path.	33
$k$	Number of rows in the routing path table.	41
$L_1$	Link set in the stationary network.	33
$L_2$	Link set in the dynamic network.	34
$M$	Set of nodes located in the routing path.	47
$n$	Number of nodes in a network.	33
$n_{neigh}$	Number of neighbors.	112
$p$	Number of selected routing paths.	59
$P_{vu}$	Total power consumption.	33
$P_{max}$	Maximum power consumption.	33
$P_T$	A predefined power threshold.	33
$FC_{sc}$	FC value from source node $S$ to crowded node $C$ .	49
$u_x$	Longitude of node $u$ .	112
$u_y$	Latitude of node $u$ .	112
$u_z$	Altitude of node $u$ .	112
$v_x$	Longitude of node $v$ .	112
$v_y$	Latitude of node $v$ .	112
$v_z$	Altitude of node $v$ .	112
$X_{sc}$	Allocated network flow rate from $S$ to crowded node $C$ .	49
$Z$	Total flow cost.	49

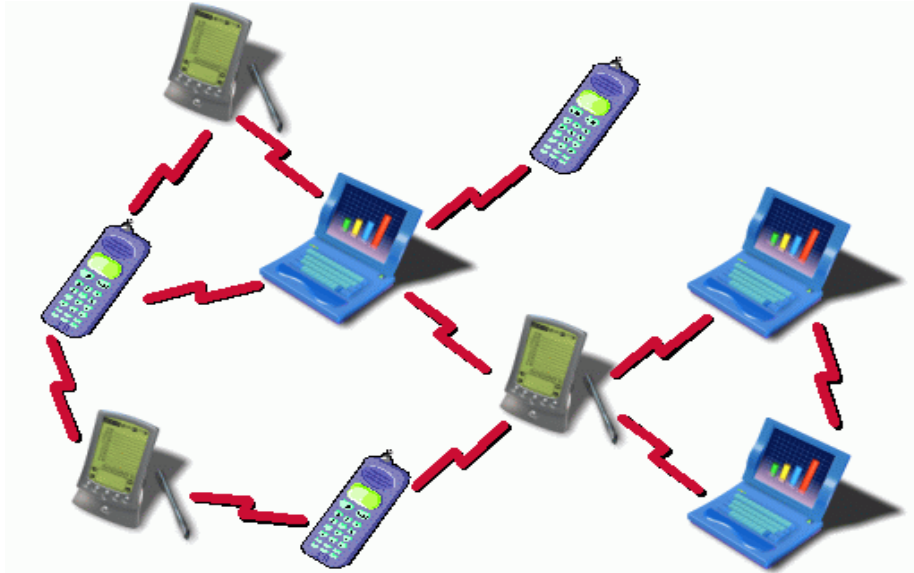
# Chapter 1

## Introduction

MANET (Mobile Ad hoc Network) has received significant attention in recent years. It does not need a fixed infrastructure and the communicating nodes are randomly distributed. All nodes cooperate to maintain network connectivity. Many related protocols such as DSR (Dynamic Source Routing) and AODV (Ad hoc On-demand Distance Vector) routing algorithm have been proposed. However, there are still many interesting problems and issues to be explored. For example, bandwidth allocation, real-time communication, three-dimensional network, etc. In this chapter, we shall first overview the MANET including its historical development, features, challenges, and applications. Then we will review some of the routing protocols, bandwidth allocation and optimization applied in MANET. Based on this, we propose our motivations, objectives, methodology and expected contributions.



**Fig.1-1: Network Based on an Infrastructure**



**Fig.1-2: Mobile Ad hoc Network**

## **1.1 Overview of MANETs**

In contrast to the infrastructure wireless networks, where each user directly communicates with an access point or based station as shown in Fig.1-1, the MANET does not rely on a fixed infrastructure for its operation as shown in Fig.1-2 [HoMo14]. Nodes in MANET can communicate directly with another node located within its radio transmission range. To communicate with the node outside of its communication range, a sequence of intermediate nodes in ad hoc networks is required to relay messages on behalf of this node, resulting in a multi-hop wireless network. The mobility of the nodes causes the nodes to be in and out of range from one another. Therefore, the connectivity in MANET varies dynamically with time. Due to its specific features, there arise many challenges in the design such as power consumption, routing protocol, bandwidth allocation, real-time communication, etc. We will discuss these issues in our thesis.

### **1.1.1 Historical Development**

Generally speaking, the life cycle of ad hoc network can be categorized into three generations. Present ad hoc network systems are considered to be the third generation. The first generation came up with PRNET (Packet Radio Network) which was sponsored by DARPA (Defense Advanced Research Projects Agency) in the early 1970s [RaBa14]. DARPA had a project named packet radio having several wireless terminals that could communicate with each other on battlefields. In conjunction with ALOHA (Additive Links On-line Hawaii Area) and CSMA (Carrier Sense Medium Access) approaches for medium access and distance vector routing, PRNET was used on a trial basis to provide different networking capabilities in a combat environment [BaRa13].

The second generation evolved in the 1980s when the ad hoc network systems were further enhanced and implemented as a part of the SURAN (Survivable Adaptive Radio Networks) program. This provides a packet switched network to the mobile battlefield in an environment without infrastructure. SURAN provides some benefits by improving the radio performance (making them smaller, cheaper and power thrifty) [SeLa14]. Important developments during this period include GloMo (Global Mobile Information System) and NTDR (Near Term Digital Radio). The goal of GloMo was to provide office-environment Ethernet-type multimedia connectivity anytime, anywhere, in handheld devices. Channel access approaches were now in the CSMA/CA and TDMA modes, and several novel routing and topology control schemes were developed. The NTDR used clustering and link-state routing and self-organized into a two-tier ad hoc network. Now used by the US Army and it is the only "real" (non-prototypical) ad hoc network in use today [RaBa14].

In the 1990s, the concept of commercial ad hoc networks arrived with notebook computers

and other viable communications equipment. At the same time, the idea of a collection of mobile nodes was proposed at several research conferences. Since the mid-1990s, a lot of work has been done on the ad hoc network standards. Within the IETF (Internet Engineering Task Force), the MANET working group was born, and made effort to standardize routing protocols for ad hoc networks. Meanwhile, the IEEE (Institute of Electrical and Electronics Engineers) 802.11 subcommittee standardized a medium access protocol that was based on collision avoidance and tolerated hidden terminals, for building mobile ad hoc network prototypes out of notebooks and 802.11 PCMCIA (Personal Computer Memory Card International Association) cards. There are currently two kinds of mobile wireless networks. The first is known as infrastructure networks with fixed and wired gateways. Typical applications of this type of "one-hop" wireless network include WLANs (Wireless Local Area Networks). The second type of mobile wireless network is the mobile network without any infrastructure, commonly known as the MANET [BaRa13].

### **1.1.2 Features and Challenges**

The mobile ad hoc network has the following features [AaTy13, BaRa13]:

#### 1) Dynamic Topology.

Nodes in MANET usually move randomly with different speeds, thus the network topology may change rapidly and at unpredictable time.

#### 2) Energy Constrained Operation.

Nodes in the ad hoc network usually rely on batteries or other exhaustible means for their energy. The design of the network is to be optimized to conserve the energy consumed by the mobiles. Many different power-aware routing algorithms and protocols have been proposed to conserve the energy of a node, e.g., [SiWo98, SpRa02,GuYa06]. For examples, an energy

efficient routing and scheduling algorithm is proposed to improve the energy efficiency [SpRa02], and adaptive antennas are used to explore the advantages of power saving [GuYa06]. However, a routing path with the lowest power consumption does not mean that it is the best routing path because there are many other factors can affect the packet transmission such as the delay and hop count.

### 3) Limited Bandwidth.

The bandwidth for wireless links is usually much lower than wired networks due to the noise, fading and interference, etc. The nature of high bit error rates of wireless connection also might be more profound in a MANET. Some or all nodes located in a specific routing path are probably shared by several other paths. Therefore, the mobile ad hoc networks need to be optimized to perform with the maximum efficiency with the limited bandwidth.

### 4) Distributed Operation.

There is no background network for the central control of the network operations; the control of the network is distributed among the nodes. The nodes involved in a MANET should cooperate with each other and communicate among themselves and each node acts as a relay as needed, to implement specific functions such as routing and security.

### 5) Multi-hop Routing.

When a node tries to send information to other nodes out of its transmission range, one or more intermediate nodes are needed. Many research works have been studied in this area, e.g., [KoAb06, LuLu00, TsMo06].

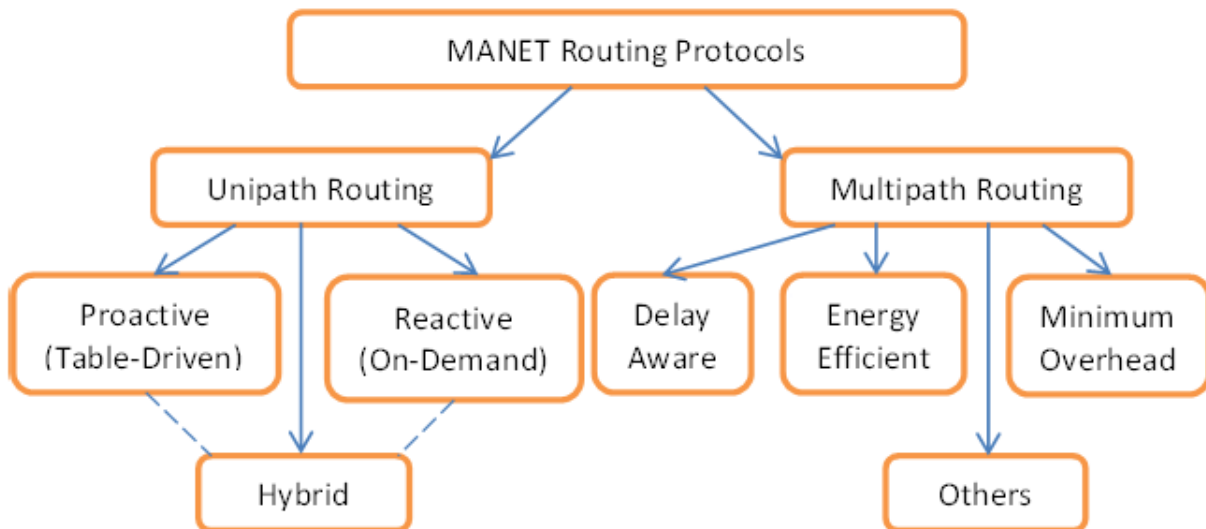
## **1.1.3 Applications**

MANET finds applications in many areas including [HoMo04]:

- 1) Emergency services: examples are search-and-rescue operation, and disaster recovery.
- 2) Commercial and civilian environments: examples are E-commerce and vehicular services.
- 3) Home and enterprise networking: examples are home office and conferences.
- 4) Education: examples are virtual classrooms and training systems.
- 5) Entertainment: examples are multi-user games and outdoor Internet access.
- 6) Sensor networks: examples are home sensors and BAN (Body Area Networks).

## 1.2 MANET Routing Protocols

The goal of routing protocols is to find the appropriate paths from source to destination. There are many different methods to classify the routing protocols. Generally speaking, based on the routing paths used during the transmission, MANET routing protocols can be classified into two categories: Unipath Routing and Multipath Routing as shown in Fig.1-3 [MuTs04, YiJi07, AaTy13].



**Fig.1-3: Classification of MANET Routing Protocols**

### **1.2.1 Unipath Routing**

A lot of current proposed routing protocols for mobile ad hoc networks are unipath routing protocols. In unipath routing, only a single route is used between a source and destination node. It can be divided into three main classes: Proactive or Table-Driven, Reactive or On-Demand and Hybrid protocols.

#### 1) Proactive Protocols.

Proactive protocols are also called Table-Driven or Table-based routing. In these kind of protocols, each node in the network has to maintain one or more tables to store the related information such as the routes to all the other nodes. Nodes must periodically exchange messages with routing information to keep routing tables up-to-date. Therefore, routes between nodes are computed and stored, even when they are not needed. Popular proactive routing protocols include DSDV (Destination Sequenced Distance Vector) [PeBh94] and WRP (Wireless Routing Protocol) [MuGa96]. They keep track of routes for all destinations and enjoy having the advantage of experiencing a minimal initial delay in communications with arbitrary destinations. When the application starts, a route can be immediately selected from the routing table. Such protocols are called proactive because they store route information even before it is needed.

#### 2) Reactive Protocols.

Reactive routing is also known as On-Demand routing protocol because it does not need to maintain the routing information or routing activity if there is no transmission between two nodes. Routes are only computed when they are needed. When a source node wants to communicate with the destination, it has to establish a route via a route discovery procedure, maintain it until the route is no longer desired or it becomes inaccessible. Thus, reactive routing is more suitable for dynamic and larger networks. Two of the widely used protocols are the DSR

(Dynamic Source Routing) [JoMa96] and AODV (Ad hoc On-demand Distance Vector) [PeRo99] protocols. Many of the multipath routing protocols are usually an extension of these two protocols.

### 3) Hybrid Protocols.

Hybrid protocols are usually a combination of the above two protocols. It aggregates a set of nodes into several zones and then proactive approach is used within each zone to maintain routing information. To communicate between zones, reactive approach is used. One example of this protocol is ZRP (Zone Routing Protocol) and ZHLS (Zone-based Hierarchical Link State) routing protocol.

## **1.2.2 Multipath Routing**

Multipath routing is the routing technique of using multiple alternative paths through a network, which can yield variety of benefits such as increasing fault tolerance, bandwidth aggregation, minimizing end-to-end delay, enhancing reliability of data transmission and improving security. The multiple paths computed might be overlapped, edge-disjointed or node-disjointed with each other [Wiki15b].

### **1.2.2.1 Background**

One of the earliest distributed multipath algorithms was formulated by Gallager [Gall77]. It assumed the stationary input traffic and fixed network. One of the main disadvantages of this algorithm is that it is hard to implement in the real world because each router needs to have information of a global constant, which is impossible to determine for all conditions [VuGa99]. Another one is the convergence; the algorithm tends to converge slowly or even does not

converge at all. Based on this condition, a lot of improvements to the algorithm had been proposed. For example, an updated scheme based on Gallager's algorithm using second derivatives has been proposed to improve the speed of convergence and parameter selection [BeGa84, TsMo06].

Multipath routing has been explored in several different contexts. Traditional circuit switched telephone networks used a type of multipath routing called alternate path routing. In alternate path routing, each source node and destination node have a set of paths (or multipath) which consist of a primary path and one or more alternate paths. Multipath routing has also been addressed in data networks such as ATM (Asynchronous Transfer Mode) networks which use a signaling protocol to set up multiple paths between a source node and a destination node. The primary (or optimal) path is used until it either fails or becomes over-utilized, and then alternate paths are tried. [MuTs04]

### **1.2.2.2 Components**

There are three fundamental components when designing the multipath routing: Path Discovery, Path Selection and Load Distribution. These three have always been the most important issues in the multipath routing. However, many papers just concerned with one or two of these three issues. For example, the SMR (Split Multipath Routing) protocol which is an on-demand MSR (Multipath Source Routing) protocol concerns about the path discovery and path selection [LeGe00]. In this algorithm, the source node sends the RREQ packet to the whole network by flooding during the path discovery. For the path selection in this algorithm, it only selects two routes and can be extended to select more. The destination replies a RREP for the first RREQ it receives, which represents the shortest delay path. Then after the destination receives more

RREQs, it will select the maximally disjoint path with the previous shortest delay path. If there is more than one maximally disjoint path, the shortest hop path is selected. If more than one shortest hop path exists, the path with the shortest time delay will be selected. The papers mainly concerned about the path selection can be found in [MaDa01, MaDa06]. It is an extension to the AODV routing which is named AOMDV (Ad hoc On-demand Multipath Distance Vector) routing by the paper. The main purpose is to compute the multiple loop-free and link-disjoint paths. Besides the link-disjoint path select, we can also choose the node-disjoint path [YeKr03]. Based on the AOMDV, a NS-AOMDV (AOMDV based on the Node State) protocol was proposed to choose the path with the largest path weight which is based on the node state for the data transmission [ZhXu13].

Once several multiple paths are selected, an algorithm is required to distribute the load. Early papers usually assume the unlimited bandwidth, e.g. [GiEp02, Vand93]. A link metric based distributed routing and scheduling algorithm is proposed [GiEp02] in order to decrease the consumption of limited resources such as the power. However, it does not take into account of limited bandwidth. An arbitrarily large bandwidth is also assumed in the derivation of the lower and upper bounds of a uniform capacity in a power-constrained wireless ad hoc network [ZhHo05]. Since the bandwidth of the ad hoc network is limited in general, more and more papers are concerned with the bandwidth utilization of networks with limited bandwidth in recent years. More will be discussed /reviewed in Section 1.3.

### **1.2.2.3 Advantages and Disadvantages**

As mentioned before, multipath routing can provide a number of benefits.

1) Fault Tolerance.

Multipath routing can provide route resilience. The source node can send the information along different paths which reduces the probability that the communication is disrupted in case of link failure. The multipath routing protocol MP-DSR (MultiPath-DSR) [LeLi01] extends the DSR protocol to provide end-to-end reliability. However, it may not be easy to find the node/link disjoint paths to provide the necessary fault tolerance and reliability. Therefore, a scheme has been proposed [YeKr03] to take advantage of reliable nodes to construct a reliable path that can increase the probability of finding reliable paths between two arbitrary nodes. In Packet Salvaging [NaDa99, VaSe03] a RERR message would propagate upstream only when an intermediate node upstream can forward the packet along an alternate route. This requires an intermediate node to maintain multiple routes to the destination.

## 2) Bandwidth Allocation

Bandwidth is usually limited in the mobile ad hoc network, routing along a single path may not provide enough bandwidth for the transmission. Multipath routing protocols can split data to the same destination node via multiple streams, each routed through a different path, and the effective bandwidth can be allocated. A bandwidth reservation scheme [LiTs01] is proposed to find multiple paths that collectively satisfy the bandwidth requirements based on the local information. In the ticket-based approach [ChTs02], a source assigns a ticket to each probe responsible for searching the routing paths. This approach does not specify how the available link bandwidth is determined or how to deal with the radio interference problem. To address this issue, a multipath routing protocol [MuTs04] calculates and reserves bandwidth based on the link information. The destination keeps track of the accumulated bandwidth for the paths it has discovered until receiving enough paths to satisfy the bandwidth requirement. However, this

algorithm may take a very long time to find enough paths to meet the bandwidth requirements thus degrading the QoS (Quality of Service) performance.

### 3) Reduced Delay.

In a single path routing protocol, a link failure usually requires a new routing discovery process to find a new route. This results in the routing discovery delay which can be minimized in the multipath routing protocol due to the backup paths available in the routing table. A traffic allocation scheme is proposed in [WaZh01] that uses weighted round robin packet distribution to improve the delay and throughput. Another scheme [DaMu00] tries to minimize the delay for sending a volume of data from source to destination by using multipath routing and intelligent traffic allocation.

Although multipath routing protocols have various advantages, they also have some disadvantages [TaTe09] as follows.

#### 1) Longer paths.

In a multipath routing protocol, packets usually travel for longer hops compared to the shortest path routing protocol. Hence, packets suffer longer delay. To avoid using excessively longer paths, a multipath routing protocol should not use all the discovered paths. Instead, the protocol should use a selected number of paths.

#### 2) Special control message.

In addition to route discovery and route maintenance control messages, a multipath routing protocol uses additional control messages. The additional control messages are used by a mobile node to collect information about its neighbors so that suitable paths can be discovered.

#### 3) Inefficient route discovery.

The route discovery process of a multipath routing may not be as efficient as that of some other routing protocols such as DSR. In the multipath routing, the source node usually has to wait until a destination replies back. While in DSR, an intermediate node is allowed to send a reply from its route cache if it has any suitable route. This route reply helps a source node to find a route to a destination in the shortest period of time because the source node does not have to wait until the request packet reaches a destination.

#### **1.2.2.4 Sub-Classification**

As revealed in the previous couple subsections, there are many more features and complications once multi-paths are possible. Therefore, the sub-classification of the existing multipath protocols is based on the prominent features that affect the performance (such as power consumption) as done in Fig.1-3. So while the classification does not appear to be parallel, the hidden unipath features are usually utilized wherever natural/applicable. For examples, the path discovery as the first essential step in multipath routing is usually table drive (proactive). Then the path selection and load distribution are usually reactive according to the traffic condition. The following are the few major categories as presented in the figure.

##### 1) DAMR (Delay Aware Multipath Routing).

The objective of DAMR is to decrease the delay during the transmission by a comparatively fair load distribution among the mobile nodes. It is more likely to have more congestion if the shortest path routing is used because the center mobile nodes have to carry much more transmissions than the others which mean a longer delay due to the unfair load distribution [PhPe03]. Thus, many papers have been proposed to reduce the delay [LiXu03, ChLe05, HuFa05, JiBh05, LiMi05]. These protocols modify the routing discovery scheme based on DSR

and AODV to find more paths with lower delay. Then a source node chooses one path with shortest delay or several paths with comparatively lower delay for the transmission. Take MSR [WaZh00] for example; it uses Probing Packets to collect the information (such as delay) of each path. Then by analyzing the multipath delay model, MSR makes a decision about when it should use multiple paths or when it should use a single path. However, there is a subtle disadvantage for these DAMR protocols, namely that lower delay does not always mean a better path because there are many other factors (such as energy, interference, hop count, etc.) that should be considered as well for a good routing path.

## 2) EEMR (Energy Efficient Multipath Routing).

Power consumption is one of the most important issues in MANET because a mobile node is usually equipped with a battery of limited power. The main objective of EEMR is to improve the energy efficiency and reduce the power consumption. The network life is maximized by efficiently utilizing the power of mobile nodes [DuWu03, LiMi05]. However, these protocols usually have a high delay and overhead.

## 3) MOMR (Minimum Overhead Multipath Routing).

The main goal for these kinds of protocols is to minimize the overhead during the communication. Multipath routing needs to discover as many paths as possible through an additional type of control messages so that it can compare all these available paths to choose several better ones. As a result, a lot of control overhead messages are generated in the network to discover and to maintain these paths. This is why we need to minimize the overhead during the multipath routing. A protocol named SMR (Split Multipath Routing) can decrease the control overhead by reducing the frequency of routing discovery [LeGe00]. It uses two multiple paths, one is the shortest path and another is the non-disjoint path with the shortest path. In this way, it

takes both the delay and overhead into consider. However, this paper does not care about the energy consumption.

#### 4) RAMR (Reliability Aware Multipath Routing)

Multipath routing has an inherent capability to provide reliability. However, which path to choose would affect the network QoS performance. Many routing protocols usually use some routing metric to select paths. If the routing metric is selected to represent end-to-end reliability, the routing protocol can identify paths with high reliability. An ETX (Expected number of transmissions) metric [DeAg05] is used to capture the forward and backward reliabilities to identify high throughput paths in a 802.11b. The minimum of forward and backward reliabilities is used as link metric [YaCo02] to find the most reliable path. However this always results in longer paths. Therefore, an updated algorithm [AwHo04] is proposed to minimize the amount of time a packet uses the network (medium time metric) in a multi-rate radio environment to maximize throughput. Per-hop Round Trip Time and Per-hop Packet Pair Delay link-quality metrics can also be used [DrPa04]. However, these metrics perform worse than the ETX metric.

#### 5) GAMR (Globally Aware Multipath Routing)

GAMR (Globally Aware Multipath Routing) has been proposed to consider the available bandwidth between a pair of communicating nodes where the bandwidth is influenced not only by the communication activities at a given node, but also by ongoing communication in nearby regions of the network because of the shared nature of the medium [KoAb06]. Its main purpose is to improve the routing performance such as throughput. However, no allocation of limited bandwidth is considered.

A local/global strategy for message routing in MANET has been offered by monitoring the signal strength of messages [TiUp02]. A host in a route that receives an incoming message

can detect possible route fluctuations locally. If the source host can find more stable routes locally, it will adapt a local route. On the other hand, the source host will be forced to search for a new route by considering the entire network which is called the global route. The problem for this paper is that it just states the idea of “Global”, but not explains it in detail. For example, there is no mention of how to choose one route among all the global routes, how to take into account the impact of other routes on the current path, and how to allocate the limited bandwidth of a link.

For the GOR (Global On-demand Routing) protocol in MANET [LeKi07], nodes do not update their routing tables immediately if they change status, such as movement, addition or deletion. Instead, nodes dynamically run the Dijkstra’s algorithm on-demand to keep the shortest paths for packet transmissions efficiently. This protocol is called “Global” because the on-demand feature covers the whole (global) network. However, there is no explanation of how to realize the related algorithms globally and how to take the related elements such as the bandwidth allocation and delay into account

One of the most recent papers about the Global Aware Routing is the scheme that generates routing paths based on the global condition of the network because it chooses the best routing path according to global network status [ZhJi14]. The routing generator takes the communication task graph and topology graph as input and computes the best routing path according to the bandwidth consumption information of the global network. However, this approach is designed for the NOC (Network-On-Chip). It is not suitable for MANET.

#### 6) HMR (Hybrid Multipath Routing)

Despite many other multipath routing protocols are classified as above with a single purpose, many have a joint consideration. For instance, the NS-AOMDV protocol [ZhXu13] does not

only consider the end-to-end time delay in path selection, but also considers both the energy consumption and the idle buffer queue.

#### 7) RTR (Real Time Routing)

Since the nodes in MANET can move randomly with a specific node speed, therefore, most of the routing protocols are not real time and can reduce the performance of transmission. That's why more and more papers are concerned on the real time routing in recent years. A real-time routing algorithm for MANET based on the reinforcement learning [Ghaf17] is proposed to predict the behavior pattern of the nodes in relation to the target node through reinforcement learning in order to give better performance in end to end delay and packet delivery ratio. However, it does not consider throughput which is an important parameter nor taking the node speed into account by assuming a comparably stable environment. The FMRM (Fuzzy controllers based Multipath Routing in MANET) algorithm [PiSu12] uses fuzzy logic to select a route. Its fuzzy controller uses different fuzzy input parameters to obtain the expiration time of each neighbor that has a route to the destination which in turn determines the priority for each node in transmitting a packet. Again, the node speed was not considered which should have an influence of the expiration time. The AdamRTP (Adaptive Multi-flows Real-time Multimedia Transport Protocol) algorithm [ZaEi09] is proposed to ease the process of transmitting multimedia traffic real-time by splitting the multimedia source stream into smaller independent flows and sending each flow to the destination using Joint paths. FT-SPEED (Fault-Tolerant real-time routing protocol) [ZhKa07] is also about how to transmit packets through routing paths in real-time. The RPAR (Real-time Power-aware Routing) [ChHe06] can achieve application-specified communication delays at low energy cost by dynamically adapting transmission power and routing decision. However, the above threementioned papers are all

applied in wireless sensor networks, not the mobile ad hoc networks. The ideas from them on sensor network can be potentially be extended/applied to MANETs.

### **1.2.3 3D Routing**

In 3D (Three Dimensional) wireless ad hoc networks, routing is one of the most challenging issues because the mobile nodes are now deployed in a 3D space, and existing 2D MANET routing solutions cannot always satisfy all 3D requirements. Few routing protocols have been designed for efficient data delivery in a 3D environment as follows.

#### **1.2.3.1 UWSN (Underwater Wireless Sensor Network) Routing**

UWSN is usually composed of different kinds of static and mobile sensor nodes to collectively perform monitoring tasks over an underwater 3D space. The traditional proactive and reactive routing solutions may not be suitable for a 3D UWSN due to slow propagated acoustic signals. A hop-by-hop hybrid implicit/explicit acknowledgement scheme [TaSe07] is proposed for multi-hop UWSN, where the downstream nodes would forward data packets and work as implicit ACKs (ACKnowledgements) for previous transmitted data packets. In the ER (Epidemic Routing) protocol [VaBe00] each node replicates a packet to every encountered node. ER utilizes every possible opportunity to deliver a packet to the destination and maximize successful delivery ratio in unconstrained networks. However, due to the high consumption of resources this routing protocol is not desirable in resource-constrained networks. As a geographic approach, the vector-based forwarding [XiCu06] scheme allows a node to measure the benefit before forwarding a packet and to discard those low-benefit ones in order to reduce energy consumption. A theoretical geographic routing based on simple propagation and energy

consumption models has been discussed in [ZoCa08] for UWSN. To keep the route shorter an optimal number of relays between source and destination are selected. The drawback is an extra level of energy is consumed to keep the minimum number of relay nodes between hops. A two-hop acknowledgment reliability model [NoLe13] insures reliable data delivery to the sinks on water surface where two copies of the same data packet are maintained in the network. The relay node can reply the ACK only if it finds the next hop towards destination. Thus each node that forwards a data packet need to wait for a certain amount of time before retransmission which is one of the disadvantages for this protocol.

### **1.2.3.2 AANET (Airborne Ad hoc NETwork) Routing**

The much higher node mobility is the most remarkable difference between 3D AANET and the other 2D MANET. Proactive, reactive and position based routing solutions are compared for AANET in [HyMu07]. It was shown that the position-based protocols can perform better. Another simulation-based study [ShSt11] stated that greedy geographic forwarding based routing protocols can be used for densely deployed AANET. However, it does not mention the Void Node Problem existed in the routing algorithm which means that the source node cannot find the next forwarding node that have shorter distance than itself. OLSR (Optimized Link State Routing) based directional optimized link state routing protocol with directional antenna is proposed for AANET routing. In DOLSR (Directional Optimized Link State Routing) [AlDo10] the sender node chooses a set of multipoint relay nodes to cover two hop neighbors, which not only reduce message overheads but also minimized latency. However, in its performance evaluations, the effect of node density and comparisons with different node speed have not taken into account. GPMOR (Geographic position mobility oriented routing) [LiSu12] proposed for

AANET predicts the movements of AANET nodes with Gaussian-Markov mobility model and uses this information to determine the next hop. While the speed in this paper is not high enough (only considers speed  $< 100$  m/s). Time-slotted on-demand routing protocol [FoHi07] proposed for AANET is a time-slotted version of AODV routing protocol. In this protocol, only one node can send data packet using dedicated time slots. Although it increases the bandwidth consumption, it mitigates the packet collisions and increases the packet delivery ratio. Another variation of AANET is the drones [KhRo18] with potentially wide application in military and commercial. A distance-based greedy routing algorithm has been proposed for the drones in the 3D network. However, this paper does not consider the void node problem.

### **1.2.3.3 Challenges of 3D Networks**

We summarize below the differences between 2D and 3D network in order to expose some of the challenges in 3D network routing.

- 1) More complicated and difficult localization in 3D network. Existing protocols in 2D networks cannot be directly applied in 3D networks due to the additional third dimension which brings more possibilities/conditions during the design of protocols.
- 2) 3D networks like the AANET are usually much more dynamic and the nodes move very fast. Thus the topology has a limited lifetime and needs frequent routing path updating.
- 3) The communication is more complicated. For example, in 3D MANETs, some mobile nodes may be located underwater, some on the surface, while the others may be in the air at different altitudes. Therefore, it usually needs to provide proper equipment for air-to-air, surface-to-air, underwater to surface and sometimes surface-to-surface communications.

- 4) Other transmission media may arise when space instead of a surface is used. For example, 3D underwater network has longer propagation delay due to the transmission medium and the acoustic waves that is often used for transmission.
- 5) New 3D applications for scientific environmental, commercial and military purposes may have their own challenges such as large delay, low bandwidth, high node mobility and high error rate due to harsh environments. Examples are pollution monitoring, disasters prevention, facilitated navigation, seaward exploration and oil/gas monitoring. Communication/routing algorithms currently used in 2D mobile nodes cannot be applied directly to 3D wireless networks.

### **1.3 Limited Bandwidth Allocation**

Bandwidth allocation has been discussed in wired network and cellular network with various multiplexing approaches such as FDMA (Frequency Division Multiple Access) [DoGk04], CDMA (Code Division Multiple Access) [GoAm00] and TDMA (Time Division Multiple Access) [KeKe04, ShCh06]. In MANET, the bandwidth is much more limited compared to the wired network, thus how to fairly and efficiently allocate the bandwidth becomes very important. Currently, the most widely used MAC (Medium Access Control) protocol in ad hoc networks is IEEE 802.11. Unfortunately, it is based on random access and thus inherently lacks the ability to manage bandwidth allocation. So we need a special bandwidth allocation algorithm.

The use of pricing as a means for allocating resources in communication networks has received much attention in recent years. Previous works (e.g. [Kell97, KeMa98, LoLa99]) have proved that pricing is an effective way to distribute the resource. According to these researches, a shadow price is associated with a communication link to reflect relation between the traffic load

of the link and its bandwidth capacity. The performance results in these papers show that a price-based strategy of resource allocation may achieve global optimum where resource is optimally utilized. There are already many papers about the Price-Based approach for the bandwidth allocation [QiMa03, XuLi03, XuLi06]. The One-Price-Based approach is to associate with each user a cost consisting of bandwidth, battery and interference [QiMa03]. Based on these components, this paper proposes the pricing model which includes the user utility function, user demand function and external demand function. Finally, it formulates these functions into an optimization problem to get the optimal solution for resource allocation. This scheme is not appropriate for MANET because it is applied in a static network topology, where each user sends traffic to a single destination node along a single and fixed path. In previous work, fair packet scheduling mechanisms have been proposed, and shown to perform effectively in providing fair shares among single-hop flows in wireless ad hoc networks and in balancing the trade-off between fairness and resource utilization [LuLu00, NaKi00, TaSa02]. However, some other people think none of the previously proposed algorithms has considered end-to-end flows spanning multiple hops which reflect more reality [XuLi03, XuLi06]. So it proposes a price-based resource allocation framework in wireless ad hoc networks to achieve optimal resource utilization and fairness among competing end-to-end flows. It uses maximal clique-associated shadow prices for wireless channel access coordination, rather than link-associated price for link access arbitration. Using this new pricing policy model for end-to-end multi-hop flows, different fairness goals can be realized in ad hoc networks.

In addition to the price-based bandwidth allocation algorithms, some other methods are also proposed in recent years. One of them is the bandwidth allocation algorithm named DBACA (Dynamic Bandwidth Allocation with Collision Avoidance) [JiZh06]. It uses a dynamical

bandwidth allocation strategy to achieve efficient bandwidth usage, and collision avoidance mechanism to get high throughput. However, this paper does not consider about the fairness, delay and interference. The energy consumption is mainly concerned when allocating the bandwidth in paper [GuYa03]. It use a capacitated multi-commodity flow model for the data flows in the networks and present a constraint formulation for this problem in terms of linear programming. The results show that when the network bandwidth is limited, it can offer a higher success rate to find a satisfactory QoS route than the traditional protocols.

## **1.4 Optimization**

In mathematics, computer science and operations research, mathematical optimization is used to find the values of a set of parameters which maximize or minimize some objective function. Optimization is central to any problem involving decision making, whether in engineering or in economics. The task of decision making entails choosing among various alternatives. This choice is governed by our desire to make the “best” decision. The area of optimization has received enormous attention in recent years, primarily because of the rapid progress in computer technology, including the development and availability of user-friendly software, high-speed and parallel processors, and artificial neural networks, etc.

### **1.4.1 General Optimization**

The general optimization involves the selection of the “best” solution from among the set of candidate solutions. The degree of goodness of the solution is quantified using an objective function which is to be minimized or maximized. The search process is undertaken subject to the system model and restrictions which are termed *constraints*. Hence, the purpose of optimization

is to maximize/minimize the value of a function (called objective function) subject to a number of restrictions (called constraints). These constraints are in the form of equality and inequality expressions as a function of the decision/optimization variables.

Over the past few decades, significant progress has been made in the field of mathematical programming which deals with the formulation, solution, and analysis of optimization problems. The analysis and solution of an optimization problem may involve graphical, algebraic

An optimization problem in which the objective function as well as all the constraints is linear is called LP (Linear Program); otherwise it is termed as NLP (Non-Linear Program). The nature of optimization variables also affects the classification of optimization programs. If all the variables in the mathematical program are integers, the optimization program is referred to as an IP (Integer Program). The most commonly used integer variables are the zero/one binary integer variables. An optimization formulation that contains continuous(real) variables as well as integer variables is called MIP (Mixed-Integer Program) [e.g., Wols08]. Depending on the linearity or non-linearity of MIPs, they are designated as MILPs (Mixed-Integer Linear Programs) [e.g., Corn08] and MINLPs (Mixed-Integer Non-Linear Programs) [e.g., TaSa02].

#### **1.4.2 Optimization in MANET**

There has been much work on optimization approaches in mobile ad hoc network. Since energy is a major concern in MANET, one obvious objective is to minimize the power consumption by formulating the routing problem as a LP (Linear Programming) optimization model [KaTa08]. However, it usually leads to other problems such as improving the end-to-end delay while minimizing the power consumption during the optimization [SiWo98]. Some work [e.g.,

BiKh10, MaMa14] propose Dynamic Route Optimization using AODV (Ad hoc On-demand Distance Vector) routing where continuous route optimization is performed in order to ensure the optimal path connection with dynamic mobile nodes. However, frequently performing route optimization can decrease the routing efficiency, and hence the efficiency issue is ignored. Of particular interest to us is the optimization in the presence of limited bandwidth during the transmission in MANET as discussed in Section 1.4. There has been optimization work based on limited resources such as [KrPa06, LeCi98]. However, those papers do not consider the intersection of transmissions from other parts of the network.

## **1.5 Motivation**

The literature review in previous sections has revealed several different issues to be desired in a mobile ad hoc network. As discussed in Section 1.1, since MANETs have their own features and challenges, suitable algorithms and protocols should be provided for this special network topology. However, many current multipath routing protocols only study some obvious network problems (such as delay and energy) and address one or two of them when in fact many factors can affect the routing performance. It would be desirable to have a routing algorithm that can simultaneously consider these critical factors to choose the multiple paths. As reviewed in Section 1.3, the link bandwidth in a real network is usually limited. So it would be desirable for this new algorithm to take into account this significant consideration and decide how to optimally utilize the bandwidth.

As implied in our discussion, we would like to first consider/adopt a multipath algorithm instead of unipath due to its obvious advantages. Our algorithm should also avoid the disadvantages of existing algorithm in not considering the influence of the communication in the

other parts of the network for the current transmission. This usually will lead to congestion or some other problems. When we choose one or multiple routes for transmitting the packets from a source, we need to share these routes with the other transmission (from other parts of the network) which is possible at any link along the path to the destination. So a globally-aware routing is also essential for our algorithm. Another important consideration is the real-time communication. How to realize a real-time routing algorithm based on a dynamic topology is also an important problem we should study.

As reviewed, there are quite a few challenges when implementing routing protocols in 3D networks, each unique for a particular application. Here, we are particularly interested in the localization and dynamic aspects such as those in the AANET application where nodes can move very fast. We would like to explore protocols that would address the void node problem and improve the forwarding node selection scheme.

In summary, there is no algorithm, to our best knowledge, that has been proposed a multipath routing protocol which simultaneously takes into account various global and critical factors and components for the allocation and optimization of limited link bandwidth in static MANET. In addition, the real-time routing during communication in a dynamic network is also a major concern in our research. Beside the study of 2D network, we would also like to explore the 3D networks which are still a comparatively new research area.

## **1.6 Objectives**

In general, we would like to study and improve multipath routing to support multimedia communication in MANETs. Specifically, we would like to:

- 1) Design multipath routing protocols that would consider various traffic and network parameters both locally and globally.
- 2) Incorporate optimization of the limited bandwidth in the routing decisions.
- 3) Demonstrate the feasibility of various improvements in supporting real-time multimedia communication in MANETs .
- 4) Explore routing algorithms for fast moving 3D MANETs

## **1.7 Methodology and Approaches**

In order to achieve our objectives, we would like to exploit the advantages of multipath routing exposed in Section 1.2.2.3 while minimizing the disadvantages. We are particularly interested in the routing categories of GAMR, HMR and RTR in Section 1.2.2.4.

To begin, we shall first provide a network model for multipath routing in a static ad hoc network where network flows both locally and far away would interact at each node. Then we formulate an algorithm that would assign to every routing path in the network a FC (Flow Cost) as a function of both queueing performance (end-to-end delay) and network parameters (hop count and remaining power consumption).

Unlike the assumption of unlimited (or big enough bandwidth) in many other algorithms, we shall consider a more practical network with limited bandwidth with the consequence of congestion due to the competition of this limited resource. An LP (Linear Programming) optimization is formulated to determine the minimum FC in all CNs (Crowded Nodes). When embedded in our algorithm this would allow us to choose the best bandwidth allocation scheme to distribute flows sharing a CN with consideration of the affect from other network flows. Of

the several optimization packages available, we have chosen the AIMMS<sup>1</sup> software [Aimm17] because it is readily available in our lab and easy to get started for the optimization solving of both linear and non-linear objective functions. We can make use of the CPLEX<sup>2</sup> solver inside it and related programming tools that allow us to solve our problem quickly.

We would like to implement and study our multipath routing algorithm initially in static networks so that we can have a better understanding of the advantages of using more than two parallel paths during the transmission. OPNET [SeHn12] is used as our simulation language because it is a popular simulation and modeling tool for network modeling. Also our CCNR (Computer Communication Network Research) group already has much OPNET expertise passed down from the previous members. This simulator is object-oriented which is scalable to give efficient simulation results. It enables network designers to design network topologies using in-built emulated objects, protocol applications and also provides great flexibility to analyzed network performance. Using OPNET would also allow us to directly compare with AODV which is already embedded in the library. Due to time limitation, coding of other algorithms was not achieved and therefore does not allow their comparisons. Having understood the mechanism and feasibility of our algorithm on static networks, we shall extend the algorithms for multipath routing in dynamic mobile ad hoc network, and test them first in small networks and then big networks. When studying routing in mobile networks, we are facing the challenge of constant link breakages due to the dynamics (of which higher speeds is one main factor) and the traditional routing updates has impacted the real-time routing capability of our algorithms. Therefore, we shall conduct a group of simulations to obtain empirical equations based on the

---

<sup>1</sup>The AIMMS possesses a unique combination of advanced features and design tools, such as the graphical model explorer, which allow us to build and maintain complex decision support applications and advanced planning systems in a fraction of the time required by conventional programming tools.

<sup>2</sup>The CPLEX solver in AIMMS is from IBM ILOG. It is a high performance solver for LP (Linear Programming), MLP (Mixed Linear Programming) and QP (Quadratic Programming) problems.

RPET (Routing Path Expiration Time) with which we can build into our algorithm to support real-time routing and multimedia communications. We would like to do some comparisons with a different protocol. Besides the above work based on the 2D MANET, we want to study the 3D network routing. We shall first focus on the issues of the 3D position and high moving speed. Presently, we already in mind to try the fast moving AANET where constant link breakages are expected. Besides studying the suitability of the topology-based algorithms we already studied, we shall also investigate the position-based types in order to account for the highly dynamic topology.

## **1.8 Contributions**

The contributions of our research work lie in the following:

- 1) A novel multipath routing protocol which uses a combination of power, time delay and hop count as the FC (Flow Cost) during the determination of the best routing path. This is different with the traditional routing algorithms which usually only consider the shortest distance or smallest delay.
- 2) The concept of “Global-Aware” is utilized in the network flow allocation: routing must take into account the influence of each node on the path as the result of the interaction of network flows converging on that node with limited bandwidth. As far as we know, there is no bandwidth allocation with this interaction carefully studied so far.
- 3) Formulation and verification of couple protocols called GANFA (Globally Aware Network Flow Allocation) based on the above “global-aware” concept and FC-AOMDV(Ad hoc On-demand Multipath Distance Vector routing based on Flow Cost)for dynamic MANET. Video application based on FC-AOMDV is evaluated.

- 4) Formulation of RPET-FC-AOMDV to improve the performance of communications with real-time requirement.
- 5) The formulation and evaluation of the FC-3DGR algorithm for fast reaction to routing information change in high-speed 3D networks while avoiding the VNP(Void Node Problem) and EDP (Equal Distance Problem).

## **1.9 Thesis Organization**

The remainder of the thesis is organized as follows. Chapter 2 provides the wireless network model, operations and assumptions for use in later part of the thesis. Chapter 3 formulates the FC-based GANFA which is a multipath routing algorithm that can optimize limited bandwidth of globally-aware network flows. The simulation and comparison results from OPNET are conducted in static MANETs. Chapter 4 formulates and studies the FC-AOMDV protocol based on Multipath AODV in the dynamic MANET. The performance evaluations and comparisons in both small network and larger network are provided. A video application is also studied. Chapter 5 incorporates an improvement to realize the real-time routing during communication. The RPET-FC-AOMDV is proposed and its performance studied. Chapter 6 formulates the routing algorithm design (FC-3DGR) a high-speed 3D mobile network. The influences of different node density and node moving speed in this 3D network topology are also compared. Chapter 7 gives the conclusion of the whole thesis and the future work. Introduction of OPNET is provided in the appendix.

## **1.10 Publications**

The following is a list of publications related to this research:

### **Chapter 3:**

- [HeYa15] Junxiao He, Oliver Yang, and Yifeng Zhou. "Globally Aware Network Flow Allocation Optimization based on Multipath Routing." *Proceedings of IEEE GLOBECOM 2015*. San Diego. Dec. 05th-10th, 2015.
- [HeYa16] Junxiao He, Oliver Yang, Yifeng Zhou, Omneya Issa."Multipath Routing Optimization with Interference Consideration in Wireless Ad hoc Network." *Proceedings of Ad Hoc Networks*. pp: 258-269, Ottawa, Canada. Sep 28-29. 2016.
- [HeYa17] Junxiao He, Oliver Yang."Globally-Aware Allocation of Limited Bandwidth in Multipath Routing based on Queueing Performance." *Proceedings of IEEE WCNC*. pp: 258-269, San Francisco, USA. Mar. 19-22. 2017.
- [HeYa18] Junxiao He, Oliver Yang, and Yifeng Zhou." Using Flow Cost to Globally Allocate and Optimize Limited Bandwidth in Multipath Routing." *Journal of Computer Networks*. Vol. 132, pp:15-25. Feb.2018.

### **Chapter 4:**

- [HeYa19] Junxiao He, Oliver Yang." Predictive Real-time Multipath Routing with Consideration of Node Speed and Node Density in MANETs." *Under preparation for journal submission, Aug. 2019*.

### **Chapter 5:**

- [HeYa19] Junxiao He, Oliver Yang."Video Application based on FC-AOMDV in MANET" *Under preparation for journal submission, Aug. 2019*.

### **Chapter 6:**

- [HeYa19] Junxiao He, Oliver Yang." FC-3DGR Design in 3D MANET." *Under preparation for journal submission, Aug. 2019*.

## **Chapter 2**

# **Network Operation, Modeling and Assumptions**

In this chapter, we shall provide the three wireless network models to be used in this thesis and their corresponding OPNET models in our simulations. We also describe the multipath routing process used in our mobile ad hoc networks. The few common assumptions used throughout our research are listed at the end.

### **2.1 Wireless Network Model**

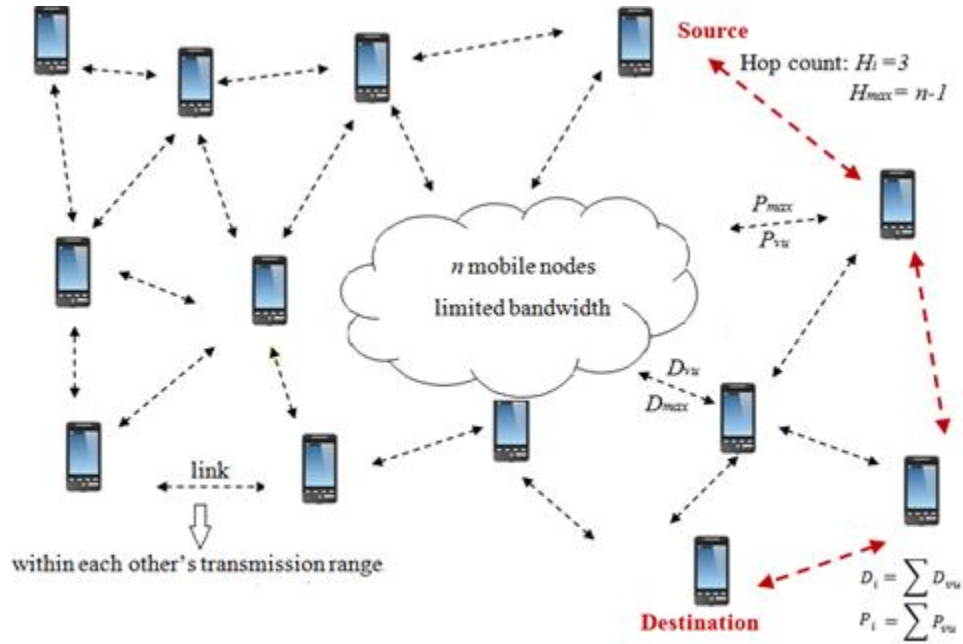
We consider a MANET (Mobile Ad hoc NETWORK) where each node is equipped with an omnidirectional antenna. Depending on the coverage, the distance from an adjacent node can be large. We shall use packet-switching in order to be compatible with most public networks. Our network supports TCP/IP operation to allow end-to-end multimedia communication.

Below is the description of the three network models we use in this thesis. The 2D (two-dimensional) static model allows us to study/test the performance of our proposed routing protocols before we extend them to the more complicated 2D-dynamic MANET and the 3D networks.

#### **2.1.1 Static Ad Hoc Network Model**

Fig.2-1 below depicts a stationary ad hoc network with  $n_l$  nodes and  $l_l$  bidirectional links. It is effectively a MANET where the nodes are not moving. The number of links  $l_l$  is usually less than the maximum of  $n_l(n_l-1)/2$ . Each mobile node has a battery with limited energy for transmission and reception through its omnidirectional antenna. The more remaining power of the battery, the longer a node can stay operational. In order to improve the stability of a routing

path and to avoid unexpected/premature link breakage caused by short-lived nodes, a node with power less than a pre-defined threshold  $P_T$  will not be selected for the transmission and therefore not included in the path selection.



**Fig.2-1: The Static Ad hoc Network Model**

Along each link  $(v, u)$ , power  $P_{vu}$  represents the total remaining power that can be used for transmission from node  $v$  to node  $u$ . Let  $D_{vu}$  be the link delay which is the sum of the propagation delay, processing delay, transmission delay and queueing delay for a packet to go from node  $v$  to node  $u$ . Since a routing path  $I$  between a source and a destination consists of the concatenation of different links, its path length can be measured in hops  $H_i$ . Another measure is the end-to-end delay which is the sum of all link delays along the routing path.

Since an outgoing link  $(v, u)$  has a finite bandwidth (data rate)  $B_{vu}$ , congestion can occur if all outgoing traffic sharing that link exceeds  $B_{vu}$ . A CN (Crowded Node) arises in this situation

when it cannot handle all the network flows with data arriving at the same time. That is, when data of all these flows are arriving at a combined rate higher than the limited bandwidth (finite data rate) of such node. The queueing delay becomes high and packets may be lost due to finite buffer space full. As detailed later, a node is deemed to be a CN when an intermediate node detects the above situation during the update of its RPT (Routing Path Table).

### **2.1.2 Dynamic Mobile Ad hoc Network Model**

We consider a dynamic MANET with  $n_2$  nodes and  $l_2$  links without any infrastructure. A link ( $u, v$ ) exists when node  $u$  can directly communicate with another node  $v$  within its transmission range. Due to the mobility, such link may break when the transmission range is exceeded. The number of routing paths would change constantly according to the relative speed, remaining power and the direction of the nodes with respect to each other.

### **2.1.3 3D Network Model**

The 2D MANET can be easily extended to 3D (Three Dimensional) with the co-ordinate of each node given by the triplet  $\{X,Y,Z\}$ . The Unit Sphere Graph concept [ShKi14] can be used to facilitate the transmission and routing of information. For example, a pair of nodes can communicate with each other if they are within the sphere of the transmission range of each other. Every node is equipped with a uniform array antenna capable of transmitting and/or receiving signals simultaneously in any arbitrary direction. Also, each node is equipped with a GPS (Global Positioning System) device to get its position information. By broadcasting, each node can gather the location information of all nodes within its transmission range. An example of the 3D network is a group of airplanes communicating with each other.

## 2.2 Multipath Routing Process

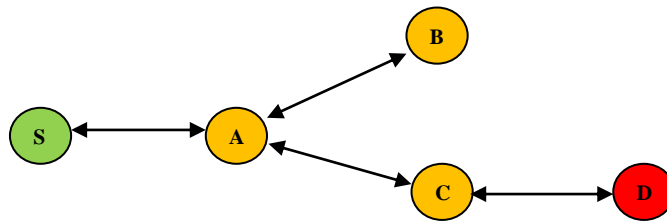
A node in ad hoc network can directly communicate with the nodes located within its transmission range. However, if it wants to communicate with the node outside of this range, a sequence of intermediate nodes is required to relay messages on behalf of this node. Multipath routing uses these intermediate nodes to form multiple routes between a source and destination. It consists of three major components: route discovery and maintenance, path selection and load distribution. These steps are commonly used in other multipath routing protocols and therefore we shall summarize them while pointing out succinctly those parts that we are going to use/modify with respect to our algorithm and optimization later on.

### 1) Route Discovery and Maintenance.

Route discovery is the process of finding the available multiple routes from a source node to a destination node. It is initiated when a source node needs to communicate with a destination node while it does not have a route in its routing table. To initiate route discovery, the source floods the network with a RREQ (Route REQuest) packet specifying the destination for which the route is requested. Each intermediate node receiving a RREQ will reply with RREP (Route REPLY) along the reverse path back to its source if a valid route to the destination is available; else the RREQ is rebroadcast. Duplicate copies of the RREQ packet received at any node are discarded. When the destination receives a RREQ, it also generates a RREP. The RREP is routed back to the source via the reverse path. As the RREP proceeds towards the source, a forward path to the destination is established.

During the routing discovery, sequence numbers play a key role in ensuring loop freedom. Every node maintains a monotonically increasing sequence number for itself. It also maintains the highest known sequence number for each destination in the routing table called the

"destination sequence number" which is used to determine the relative freshness of two pieces of routing information generated by two nodes for the same destination. The node with a higher destination sequence number has the more recent routing information. In this way, a node can know if the received packets are duplicate or not. It also includes a field named "hop count" which is used as a routing path length metric in the Flow Cost calculation in Chapter 3.



**Fig.2-2: Example Network for Route Discovery**

Fig.2-2 exemplifies the route discovery process when Node S wants to send packets to node D, as follows:

- a) S creates a Route Request(RREQ) with D's address in the Destination Address field, S's address in the Source Address field, The sequence number is called the "destination sequence number". It is updated whenever a node receives new information about the sequence number from RREQ, RREP, or RERR messages that may be received related to that destination.
- b) S broadcasts RREQ to all its downstream neighbours. In this case, it is node A only.
- c) After receiving the RREQ packet from node S, node A makes a reverse route entry by recording its upstream node (which is node S in this case) in the "Next\_hop" field of the packet and check if it has a fresh route to D as indicated by the content of the "Next\_hop" field. If A already has the path to D, S will directly choose this path for transmission. If not, node A will rebroadcast RREQ to its downstream nodes. In this case, nodes B and C.

- d) After receiving the RREQ, node B finds it does not has any connections with the other nodes, thus will discard the RREQ.
- e) After receiving the RREQ, Node C makes a reverse route entry for S and finds it has a route to D. So it creates a Route Reply (RREP) and sends it back to node A.
- f) After receiving the RREP from node C, node A sends the RREP to node S.
- g) Node S receives RREP, it will make a forward route entry to D.

One can see that after each Routing Discovery, an intermediate node can acquire all the related information (such as its next-node number in the routing path and end-to-end delay from the source) from the RREP packets it received, and therefore can detect all the routing paths through it to a given destination. These paths will be saved in the RPT (Routing Path Table) in increasing order of their end-to-end delays. Our optimization algorithm Chapter 3 later will make use of this multipath information to update the RPT further using both the FC and node-disjoint method to simplify the table.

During Route Maintenance, when an upstream node detects a link failure due to the movement of a downstream node or for some other reasons, a Route Error (RERR) will be initiated by the node upstream (closer to the source) of the break. This RERR is propagated to all the affected destinations. RERR lists all the nodes affected by the link failure. When a node receives an RERR, it marks its routes to the destination as invalid. When a source node receives an RERR, it can use the alternate path or reinitiate the route discovery.

## 2) Path Selection.

After discovering all possible routing paths, it is also important to select one or several appropriate paths according to certain QoS metrics such as path reliability, disjointness, available

bandwidth, degree of route coupling or a combination of these metrics. Generally speaking, there are three kinds of routing paths:

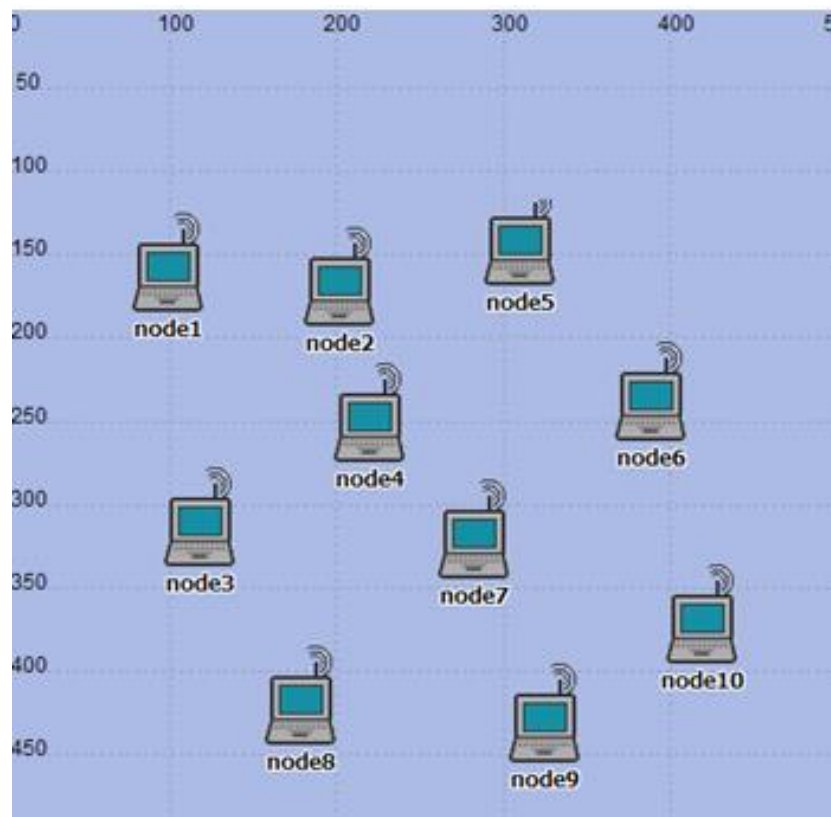
- a) Node-disjoint are paths that have no nodes in common between any two paths between the source and the destination. Depending on its topology, sometimes it is difficult to find node-disjoint paths in a network.
- b) Link-disjoint paths are paths that have no link in common but may still share one or more nodes between the source and the destination. This allows more possible paths than the node-disjoint paths for a given network. However, link failure may cause more than one path to fail concurrently. Note that node-disjoint paths are automatically link-disjoint paths.
- c) Non-disjoint paths can have nodes and links in common.

Disjoint routes usually offer more advantages over non-disjoint routes such as higher available bandwidth. In principle, node-disjoint routes offer the most available bandwidth because neither links nor nodes are shared between the paths, and therefore the bandwidth that can be used is more than non-disjoint paths. Disjoint routes also provide higher fault-tolerance. When using non-disjoint routes, a single link or node failure can cause multiple routes to fail. In node or link disjoint routes, a link failure will only cause a single route to fail. However, with link-disjoint routes, a node failure can cause multiple routes that share that node to fail. Thus, node-disjoint routes offer the highest degree of fault-tolerance and is often preferred in multipath routing.

Section 3.2.1 uses a combination of several QoS parameters in a FC to select the paths in RPT while Section 3.4.1 uses node-disjointness in addition to update path selection. These are further exploited in a dynamic network topology in Chapter 4.

## 2.3 OPNET Models

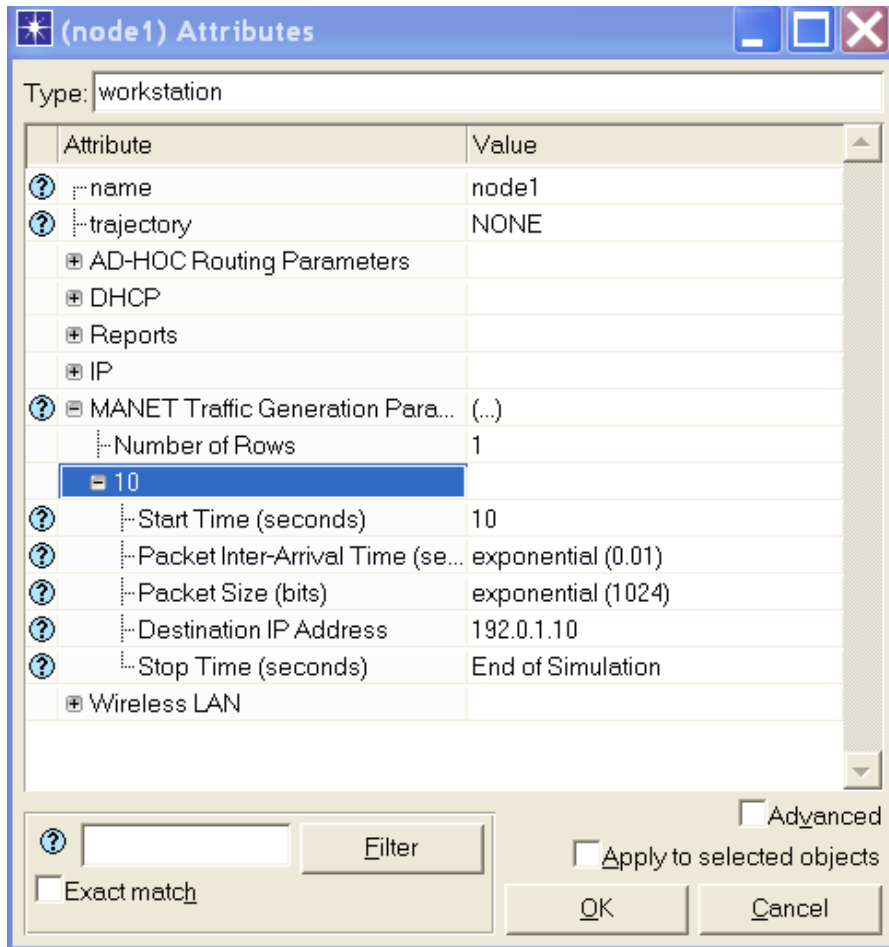
As discussed in Chapter 1, OPNET has a hierarchical structure that would allow us to simulate a network to any details. Here we shall provide the OPNET models for the static and dynamic 2D networks at the network level along with the common parameters to be used. We do not give the diagrams for 3D networks as the difference is only reflected in the coding such as the changes related to the 3rd coordinate.



**Fig.2-3: OPNET Model for a Static Network**

### 2.3.1 Static Network Model

Fig.2-3 shows the OPNET network model of a network of fixed MANET stations (10 in this case) deployed over a given area (500m x 500m in this example) to be used in Chapter 3. The positions of each node can also be moved arbitrarily.

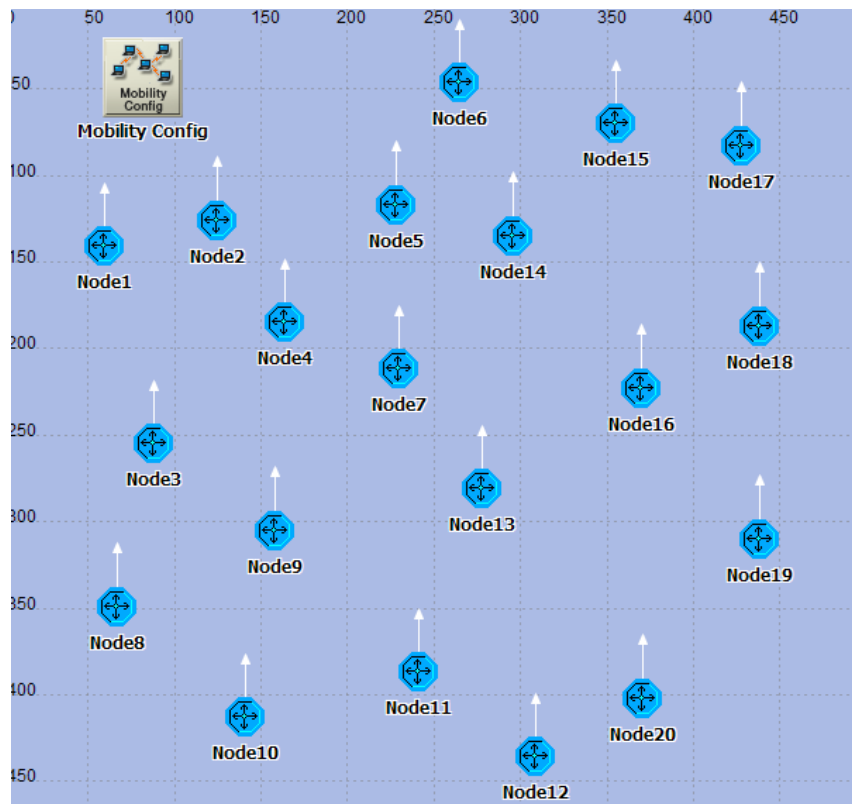


**Fig.2-4:Node Attributes in the Network Model**

Each node has certain attributes for its operation as exemplified in Fig.2-4. Some relevant attributes are as follows:

- 1) Trajectory is set to NONE which means there is no node movement and the network is stationary.
- 2) AD-HOC Routing Parameters is used to set the routing protocol used in the transmission. The default routing protocols in the nodes model can be AODV, DSR, OLSR, TORA and GRP. These routing protocols can be modified according to the specific requirements or added a new designed routing protocol in the list.

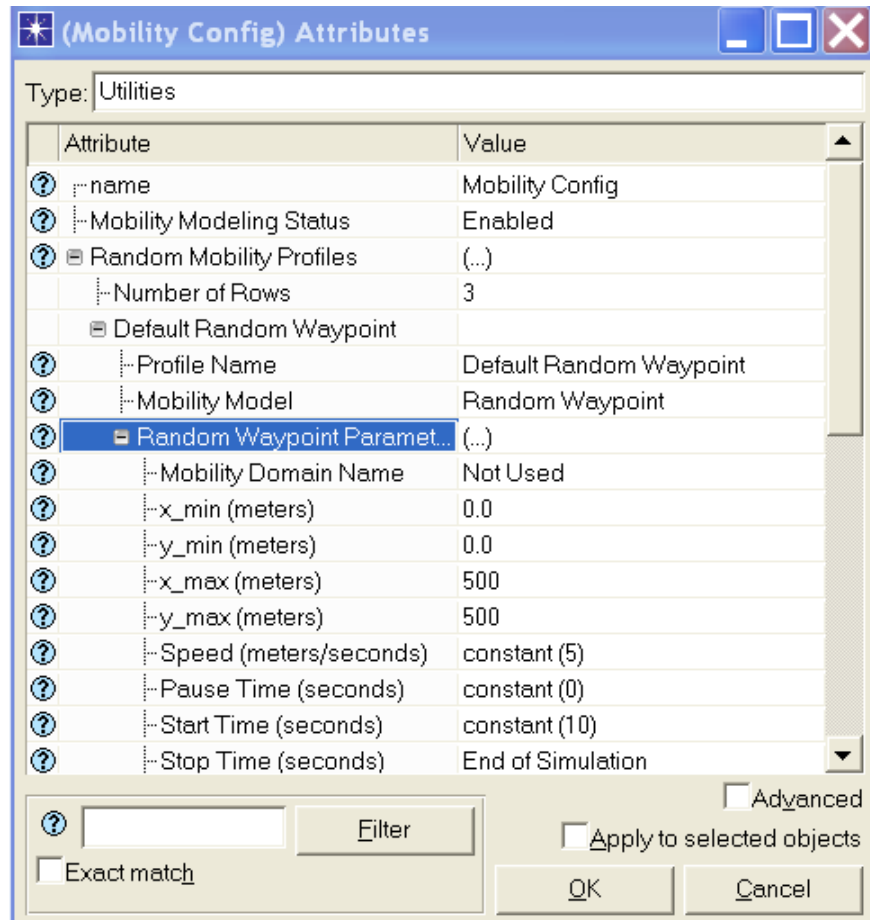
- 3) MANET Traffic Generation Parameters is used to set the transmission starting and stopping time, the packet size and packet arrival rate, most importantly, to set the destination address of this node. If "the number of rows" is set to 0, then it means this node is not the source node which will initiate the packet transmission.
- 4) IP is used to distribute the IP addresses for the nodes in the moving area. The other parameters in the field of DHCP, Reports, and Wireless LAN are used the default values. We did not make changes.



**Fig.2-5:Dynamic Network Model in OPNET**

### 2.3.2 Dynamic Network Model

Fig.2-5 shows an example of our dynamic network topology with 20 moving nodes over a 500mx500m to be studied in Chapter 4. The node attributes are the same as those in Fig.2-4.



**Fig.2-6: Mobility Configuration Attributes**

Fig.2-6 shows the mobility configuration used in each mobile node for our study in Chapters 4 and 5. Mobility Model allows us to depict how a node would move over the area. The RWM (Random Waypoint Mobility) model is used in this study where nodes are randomly positioned within the deployment area in the beginning of a simulation. Following are some pertinent parameters:

- 1) Speed: the speed at which a node uses to move towards a randomly chosen location.
- 2) Pause Time: the wait time after a node reaches its destination and before it starts a new movement. This Pause Time is used to adjust the level of mobility. When it is set to 0, the nodes move continuously without stopping, which provides a maximally mobile setting. On

the other hand, when pause time is set to the duration of the entire simulation, the nodes remain fixed and becomes a stationary network as studied in Chapter 3.

- 3) x-min and x-max specify the left and right border of the movement area on x-axis.
- 4) y-min and y-max specify the upper and lower border of the movement area on y-axis.

## **2.4 Performance Measures Definition**

In our thesis, we mainly evaluate the end-to-end delay, throughput and packet delivery ratio because these 3 parameters are the most important ones commonly used to show the network performance. In addition, they can be directly chosen in OPNET through DES (Discrete Event Simulation) settings. The definitions are as below:

### 1) End-to-End Delay.

The end-to-end delay is the duration from the time a packet is sent from the source node until it is received by its destination node. It includes the propagation delay, processing delay and the queueing delay. In our OPNET simulations, this duration is from the time a packet is generated in the source node until the time it is successfully received by the sink node. Its components include the queueing delay at the intermediate nodes, the processing delay at each node as well as the propagation delay.

There are two types of delay presented in later chapters. The instantaneous end-to-end delay shows the delay of each packet received at the destination while the average end-to-end delay is the average of all packets received at the destination over a period of time. The packets that are lost before reaching destination due to error or some other reasons do not contribute to the average delay.

### 2) Throughput.

Throughput is the amount of data (measured in bits) that successfully received by the receiver per unit time at all destination nodes in a network.

### 3) Packet Delivery Ratio.

Packet delivery ratio is the percentage of packets from the source that are successfully received at the intended receiver. In our OPNET simulation, this is the fraction of the number of successfully received packets at the receiver out of the total number of packets sent by source up to time  $t$  since the beginning of the simulation.

For the above performance evaluations, when there are multiple data streams in simulations, we take the average of all data streams.

## 2.5 Assumptions

Unless otherwise specified, the following assumptions pertain the rest of this thesis unless otherwise specified. Many of these are commonly used in the literature.

- 1) Number of nodes is finite. We shall have less than 100 in our study.
- 2) The end-to-end delay for each link is fixed until the next Route Discovery. In other words, we are considering the quasi-stationary of network operation where certain performance can remain constant over a short period of time.
- 3) The mutual interference from other wireless channels are not studied in our thesis. If it is necessary, they can be considered as noise under SNR (Signal to Noise Ratio) in OPNET modeling.
- 4) A destination always has enough buffers to receive data from its source. This is because we do not want the destination to impose any constraint on the source sending rate when we verify the effect of our new control scheme in the bottlenecked router.

- 5) We set the link service rate to a very large value in the parameter settings so that we do not need to consider the constraint due to the link rate during our performance simulations and comparisons.
- 6) Each node in the same scenario would have the same moving speed and cannot move out of the specific area of study
- 7) For simplicity but without loss of generality, each node has the same maximum transmission power and transmission range. The power supplied at each node comes from the battery of antenna which is finite but enough for the transmission.

## Chapter 3

### GANFA Based on Multipath Routing in Static MANETs

In this chapter, we shall study how multipath routing can provide an aggregate bandwidth to satisfy a communication needed in a static mobile ad hoc network where each link has limited bandwidth. We shall first introduce the Flow Cost (FC) concept to integrate the performance requirement in delay, available transmission power and path length and use it as criteria to decide which paths (can be more than one) to choose. Then we shall propose the GANFA optimization model using to globally-aware allocate the bandwidth to each flow in order to obtain the least TFC (Total Flow Cost). With the experience gained from the initial study, we have improved the algorithm by accounting for the queuing performance and introducing the node-disjoint feature to avoid multiple link breakages arising from the failure of the same node in a large network. We have evaluated and compared different performance using AIMMS and OPNET simulations.

#### 3.1 The GANFA (Globally Aware Network Flow Allocation) Algorithm

As introduced in Section 1.2.2.4, Global Awareness in multipath routing considers the influence of communication activities in the nearby regions of a given network node on the available outgoing link bandwidth between such node and its destination. By using a new measure called the Flow Cost and the terminology of Crowded Node, we would like to formulate an optimum flow allocation algorithm that is globally aware of the other flows for multipath routing under the constraint of limited bandwidth available at each outgoing link. The purpose of the optimization is to globally consider all the network flows converging in CNs and then choose the best bandwidth allocation scheme. Below we shall first define Flow Cost and Crowded Node properly

before formulating our algorithms. The assumptions used in this chapter are as below:

- 1) The number of network flows for the crowded node can be obtained through RREQ packet and fixed for the current transmission.
- 2) The bandwidth (data rate) of a node is limited. This is practical because the total bandwidth of its outgoing links is limited.
- 3) Network connection breakage rarely happens in the stationary MANET in this chapter.

### 3.1.1 Flow Cost for Path Ranking

As introduced in Section 2.2, after each route discovery, we have in our RPT (Routing Path Table) of all available paths from source to the destination. We would like to sort all these paths according to a new measure called the FC (Flow Cost) which jointly consider the following 5 parameters:

- 1)  $P_T$ : The power threshold which is used to exclude the short lifetime nodes. Only the nodes with power larger than  $P_T$  is considered for the routing path selection.
- 2)  $P_{vu}$ : The total remaining power that can be used for transmission or reception. The higher  $P_{vu}$  means the longer lifetime of the link in the routing path.
- 3)  $H_i$ : the path length of a route. Obviously, we have  $H_i \leq n-1, i=1,2,\dots,m$  (see Chapter 2)
- 4)  $D_{vu}$ : link delay as introduced in the network model (see Chapter 2)
- 5)  $D_{max}$ : a maximum value that is larger than the delay for any other links in the network. In our research, the default value of  $D_{max}$  is based on the routing discovery time. Therefore, different  $D_{max}$  values are used for different network sizes.

We can now determine the FC of a routing path  $i$  (in the RPT) as the total contributions of all the above parameters from all links along the path. Let  $FC_i$  be the Flow Cost of the  $i^{th}$  path in

the RPT and  $M$  be the set of nodes in the routing path such that  $(v, u) \in M$  means the set of concatenated links to form the path. Then we have

$$FC_i = \sum_{(v,u) \in M} \left( \frac{P_T}{P_{vu}} + \frac{D_{vu}}{D_{max}} \right) + \frac{H_i}{n-1} \quad (3-1)$$

Since the power, delay and hop count take on different units and different magnitude, we have normalized each parameter (i.e.  $P_T$ ,  $D_{max}$  and  $n-1$  respectively) so that their contributions become values between 0 and 1. We can now sort/update all the paths in the RPT according to their FCs in their ascending order. The routing path with the smallest FC is the optimal path to be saved in the first row of the RPT. Its path index number is 1. The routing path with the second smallest FC is called the sub-optimal path and saved in the second row with an index number 2, and so on and so forth. A path with an index  $i$  larger than 2 is called the  $i^{th}$ -backup path. A smaller FC indicates a routing path with a combination of more remaining power, lower/smaller end-to-end delay and smaller hop count. Without loss of generality, we shall choose two paths in our multipath routing algorithm to carry the network flows: an optimal path with the least FC contributed from its links, and a sub-optimal path with the second-smallest FC.

### 3.1.2 Crowded Node

Since an outgoing link  $(v, u)$  has a finite bandwidth (data rate)  $B_{vu}$ , congestion can occur if all outgoing traffic sharing that link exceeds  $B_{vu}$ . A CN (Crowded Node) arises in this situation when it cannot handle all the network flows with data arriving at the same time. That is, when data of all these flows are arriving at a combined rate higher than the limited bandwidth (finite data rate) of such node. The queuing delay becomes high and packets may be lost due to finite buffer space full. We would like to assign a CN for each routing path used for packet transmission. A node is deemed to be a CN in a routing path when it has the minimum value of

(bandwidth/number of neighbors) which we can call it the mean bandwidth for each neighbor. The smaller bandwidth with more neighbors of a node would be more likely to be a bottleneck during the transmission and thus cause the congestion. We are going to further illustrate this definition in the example of Section 3.1.5.

### 3.1.3 The Optimization Problem Formulation

For a given pair of nodes, the available bandwidth of their link is not only used by any direct communication between the two nodes, but also has to be shared by the flows from anywhere in the network as part of their paths. If the link bandwidth is very limited, congestion and high delay may result. Therefore, multipath routing to provide load balancing for bandwidth limited network should reduce congestion and overall network delay. Consequently, the criteria to decide which paths (can be more than one) are the key issue/problem. Since a node can take on path flows from different source-destination communication pairs in the network and each flow can be adjusted from the source, it would be good if a CN can inform the source what data rate the path it has chosen to go through this CN. Then it boils down to an optimization to be carried out at a CN. Note that our concern in this formulation is for the optimization of a given set of flows once they are found but not the best optimal results among any possible set of paths.

The objective is to obtain the minimum total flow cost  $Z$  so that the allocation combination of the flow cost  $FC_{sc}$  and the flow amount  $X_{sc}$  can be identified.

$$\text{Minimize } Z = \sum_{s,c \in M} FC_{sc} * X_{sc} \quad (3-2)$$

Subject to:

$$\sum_s X_{sc} \leq C_c, \quad \forall c \in M \quad (3-3)$$

$$\sum_c X_{sc} \geq D_s, \quad \forall s \in M \quad (3-4)$$

$$X_{sc} \geq 0 \quad (3-5)$$

Constraint (3-3) says that the sum of data rates from all network flows cannot exceed the maximum capacity (data rate) of a CN. Constraint (3-4) says that the sum of all outgoing path capacities supporting the flows from the same source should be greater than the source data rate. Constraint (3-5) is just a regular condition to ensure the non-negativity of a flow value.

In summary, the purpose of this optimization is to jointly consider all the network flows going through the CNs for the optimization of a particular path. It then chooses the best bandwidth allocation  $X_{sc}$  for each flow from source S going through the crowded node C.

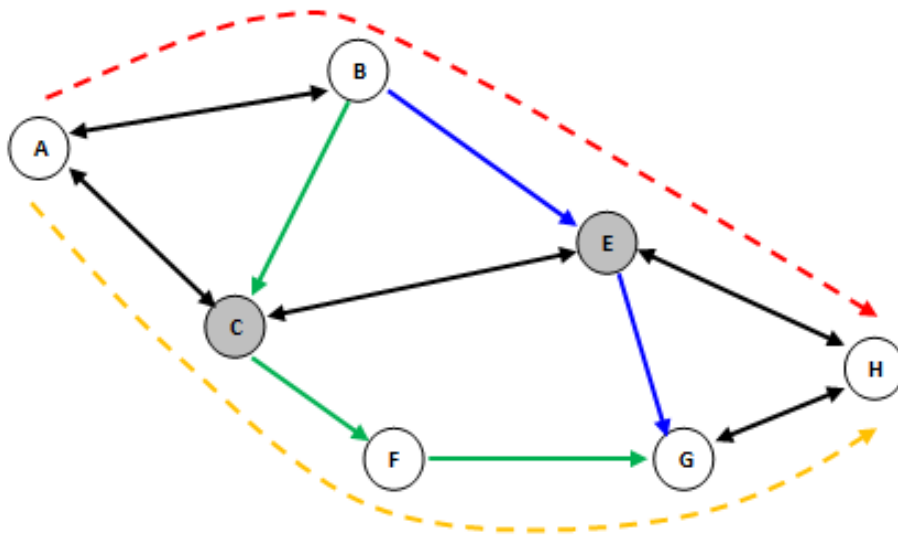
### **3.1.4 The GANFA Algorithm Design**

This algorithm attempts to optimize the allocation of the limited bandwidth available at a Crowded Node by taking into account the influence of flows that can arise from anywhere in the network. This algorithm will execute every time when there is a route discovery from a source by updating all the entries for that source. The results of the optimization would allow us to choose the best bandwidth allocation scheme among all paths between a source-destination pair. Locally the algorithm appears to be centralized where a destination node would collect all routing path information to select the best one while a source node performs optimization on bandwidth allocation. But since the cooperation can take place between any pair of source and destination nodes, this algorithm can be considered distributed for network operation as there is not a central node that determines everything.

The GANFA algorithm makes use of all issues discussed earlier as shown in the following steps:

- 1) Use the routing discovery algorithm in Chapter 2 to obtain all the routing paths for the present transmission and save them in the RPT.

- 2) Use the FC to rank the routing paths in ascending order in the RPT (Section 3.1.1).
- 3) Identify all Crowded Nodes in the optimum and sub-optimum paths of the RPT (Section 3.1.2).
- 4) Identify all flows sharing the crowded nodes and their data rates.
- 5) Carry out the optimization to obtain bandwidth allocation to each flow in a Crowded Node (Section 3.1.3)



**Fig.3-1: A Small Network Example with 2 Pairs' Transmission**

### 3.1.5 Example

We shall use an example to illustrate the algorithm further. Fig.3-1 is a small network with  $N=7$  nodes and  $m=2$  network flows: Flow BG (i.e. from source node B to destination node G) and flow AH. There are many available routing paths from source node to destination node. For example, for Flow BG, available routing paths can be BEG, BCFG, BEHG, BCEG, BACFG, BACEG, etc; for Flow AH, available routing paths can be ABEH, ACFGH, ACEH, ABCEH, ABCFGH, ACEGH, etc. AFC can be calculated for each path based on equation 3-1. Suppose the optimal routing path with the smallest FC for flow BG is BEG (indicated by blue one) and the

sub-optimal routing path with second smallest FC is BCFG (the green one). Likewise, the optimal routing path for flow AH is ABEH (the red one) and the sub-optimal routing path is ACFGH (the yellow one). Then after the path ranking, BEG and BCFG will be chosen for packet transmitting of flow BG; ABEH and ACFGH will be chosen for packet transmitting of flow AH. Let node E be the crowded node for the two optimal routing paths and node C is the Crowded Node for the two sub-optimal routing paths. Assume the maximum bandwidth for node C is  $B_C=100$  Kbps and for node E is  $B_E=80$  Kbps. The data rate for flow BG is  $R_{BG}=70$  Kbps and for flow AH is  $R_{AH}=80$  Kbps. One of the possible allocation is  $B_{E,BG}=30$  Kbps;  $B_{E,AH}=40$  Kbps;  $B_{C,BG}=40$  Kbps;  $B_{C,AH}=40$  Kbps. Another possible allocation is  $B_{E,BG}=70$  Kbps;  $B_{E,AH}=10$  Kbps;  $B_{C,BG}=0$  Kbps;  $B_{C,AH}=70$  Kbps. There are many possible solutions like this. So the goal of our optimization is to choose the best allocation scheme with the least TFC (Total Flow Cost).

### 3.2 Optimization Performance of GANFA

We shall use the AIMMS (Advanced Integrated Multidimensional Modeling Software) [Aimm19] solver to solve our optimization problem. As reviewed in Chapter 1, AIMMS offers an easy to use and all-round development environment for creating fully functional ADS (Analytic Decision Support) applications ready for use by end-users.

**Table 3-1: Data Rate of Source Nodes**

Source	Data Rate
SourceNode 1	30 Kbps
SourceNode 2	50 Kbps
SourceNode 3	45 Kbps
SourceNode 4	40 Kbps
SourceNode 5	60 Kbps

In our performance study, we shall use a topology with  $m=5$  network flows and 3 CNs. Table 3-1 shows the data rates of  $S=5$  source nodes that give rise to the 5 flows. Each network flow can be distributed/split into its optimal routing path and sub-optimal routing path if necessary. So there can be up to 10 routing paths in total to carry all transmissions simultaneously.

**Table 3-2: Crowded Node Capacity**

<b>Crowded Node</b>	<b>Maximum Capacity</b>
CrowdedNode 1	60 Kbps
CrowdedNode 2	70 Kbps
CrowdedNode 3	95 Kbps

Table 3-2 shows the maximum capacity (data rates) of 3 CNs (A, B and C) arising from nodes that are shared by the 10 routing paths. We want to test our GANFA algorithm on the interaction of flows at these CNs.

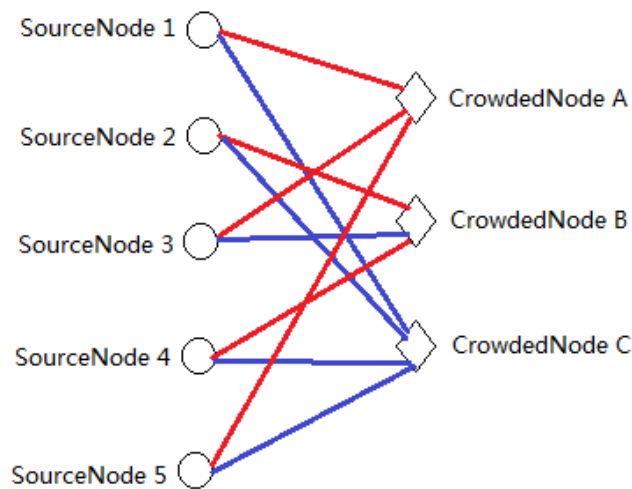
**Table 3-3: Flow Cost**

	<b>Flow Cost</b>		
	<i>Crowded Node A</i>	<i>Crowded Node B</i>	<i>Crowded Node C</i>
SourceNode 1	2.9	$\infty$	3.9
SourceNode 2	$\infty$	1.4	2.3
SourceNode 3	1.2	2.8	$\infty$
SourceNode 4	$\infty$	2.4	4.5
SourceNode 5	1.7	$\infty$	3.1

Table 3-3 below shows the FCs of the routing paths from different sources to each crowded node. The value of FC can be got by the eqn. (3-1). Here we use some sample values during our optimization solving. The smaller value in the same row means the FC of the optimal routing path and another bigger one is for the sub-optimal routing path. Different FCs will lead to

different network flow allocation results.

The symbol of  $\infty$  in Table 3-3 indicates there is no network flow to that Crowded Node. Take Source Node 1 for example, the optimal routing path for it is the path through Crowded Node A with a FC=2.9 and the sub-optimal routing path for it is the path through Crowded Node C with a FC=3.9. Similarly, for Source Node 2, the optimal routing path for it is the path through Crowded Node B with a FC=1.4 and the sub-optimal routing path for it is the path through Crowded Node C with a FC=2.3.

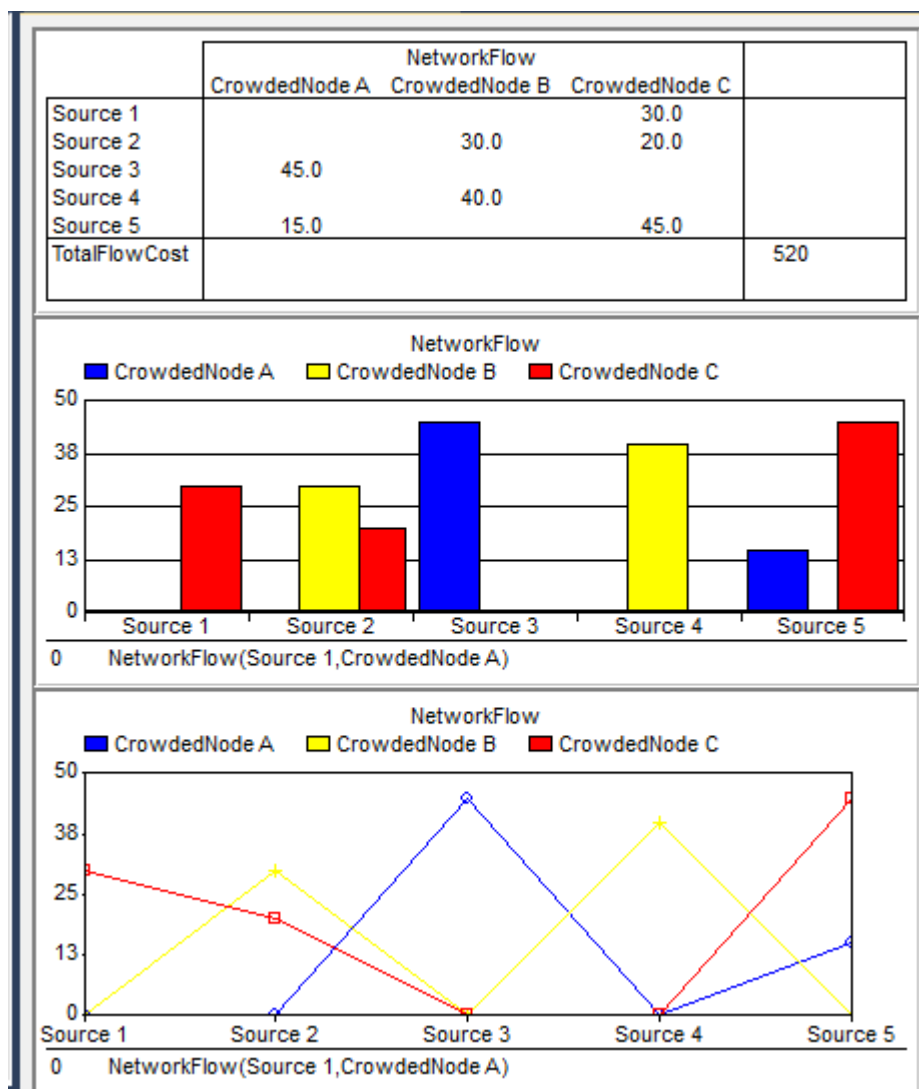


**Fig.3-2: Topology after Network Flow Assignment**

Fig.3-2 shows one scenario of how the optimal (shown in red) and the suboptimal (shown in blue) paths of each source node interact at the 3 CNs. Therefore, Crowded Node A has to share the bandwidth among 3 optimal routing paths from sources 1, 3 and 5. Likewise, Crowded Node B takes on 3 paths (this time, 2 optimal paths from sources 2 and 4 and one sub-optimal path from source 3). Finally, Crowded Node C has to share its bandwidth among 4 sub-optimal routing paths from sources 1, 2, 4 and 5.

READY	
Math.Program	: LeastCostFlowPlan
# Constraints	: 9
# Variables	: 16
# Nonzeros	: 46
Model Type	: LP
Direction	: minimize
SOLVER	: CPLEX 12.6.1

**Fig.3-3: Optimization Model Information**



**Fig.3-4: Optimization Result**

After running the AIMMS (Version 12.6.1), we can get the LP (Linear Programming) optimization model related information as shown in Fig.3-3. We can see, in our LP optimization model we have 9 constraints and 16 variables when we apply the data in Table 3-1, Table 3-2 and Table 3-3 into the optimization formulation in Section3.1.

Fig.3-4 shows the results solved by the Solver in a table which can also be viewed in the format of a histogram and a graph. We can see Source Node 1, 3 and 4 cannot be separated into two network flows. Source Node 1 can use its sub-optimal routing path to carry the whole network flow according to the allocation. Both Source Nodes 3 and 4 will use its optimal routing path to carry the full transmission. On the other hand, Source Node 2 has to use its optimal routing path to carry 30 Kbps and its sub-optimal routing path to carry the remaining 20 Kbps. For Source Node 5, its optimal routing path will carry 15 Kbps and the remaining 45 Kbps will be given to its sub-optimal path. In this allocation scheme, we can get the optimal cost  $TFC=520$ .

### **3.3 The Improved GANFA Algorithm**

The network flow allocation algorithm in the Section 3.2 has some disadvantages. One is that the multiple routing paths may be node or link joint which means more than one path can break due to same node- or link- failure. Another one is that it is based on the assumption that there is no queueing delay. However, queueing performance is an essential factor that we should consider during our routing protocol and bandwidth allocation. So we shall formulate an optimization model that not only consider the FC (Flow Cost) but also take the utilization factor into account. The utilization factor at a node is considered because it is related to the queueing performance such as queue length and queueing delay. Whilst there are other factors contributing to queueing delay, we make use of the fundamental queueing knowledge that higher utilization usually

results in longer delay. In addition, the FC values are directly given in GANFA. It is not clear as how a FC is determined. Therefore, we shall propose an updated algorithm with the consideration of utilization factor for some larger networks in this section.

### 3.3.1 The Updated Flow Cost Calculation

Unlike the Flow Cost in eqn. (3-1) in Section 3.1.1, we shall adopt a more general equation by adding weight factors for the power, delay and hop count components so that their importance can be emphasized if needed. Let  $FC_i$  be the Flow Cost of the  $i^{th}$  path in the RPT and  $M$  be the set of nodes in the routing path such that  $(v, u) \in M$  means the set of concatenated links to form the path. Then we have

$$FC_i = \sum_{(v,u) \in M} \left( \alpha * \frac{P_T}{P_{vu}} + \beta * \frac{D_{vu}}{D_{max}} \right) + \gamma * \frac{Hi}{n-1} \quad (3-6)$$

As in eqn. (3-1), we have normalized each parameter (i.e.,  $P_T$ ,  $D_{max}$ , and  $n-1$  respectively) so that their contributions become values between 0 and 1. The variable  $\alpha$ ,  $\beta$  and  $\gamma$  are the weights associated with their respective parameters in order for us to emphasize the contribution of a parameter in the FC which we have  $\alpha + \beta + \gamma = 1$ . We shall use the default values of  $\alpha = 0.3$ ,  $\beta = 0.3$ ,  $\gamma = 0.4$  in this research unless otherwise specified.

### 3.3.2 Node-disjoint Routing Path Selection

For a large network in general, many disjoint paths can be found during the routing discovery operation, and its number can be so large that can decrease the algorithm efficiency and increase the memory usage. Therefore, we need a scheme to decrease the number of the routes in order to improve algorithm efficiency. Of the several types of disjoint routing paths classified in Section

2.2, we shall use node-disjoint paths. That is, a set of node-disjoint paths with no common nodes except their source and destination. Node-disjoint paths are usually fault-tolerant because they can utilize the most available network resources. When an intermediate node in a set of node-disjoint paths fails, only the path containing the failed node is affected with minimum impact to the other routes.

We shall choose the node-disjoint paths for path ranking in Section 3.1.1. As before, the routing path with smallest FC is saved in the first row of the RPT. A smallest FC indicates a routing path with higher remaining power, lower end-to-end delay and smaller hop count. To ensure node-disjointness of the paths in the table, we shall compare all routing paths to see if they share the same node. When two or more routing paths share one same node, we will delete the one with higher FC (larger row number in the RPT) until all the remaining routing paths are node-disjoint. We first obtain the node numbers in the first routing path (the one in the first row with lowest FC), then we compare it with the node numbers saved in the second row. If they have one or more same node numbers, we will delete the second row from the RPT. Next, compare the node numbers with the third row, fourth row, etc. After the first iteration, all the paths in RPT will be node-disjoint with the first one. Now we begin our second iteration to compare the second row with the others. Then third iteration to compare the third row with the others, the fourth iteration, etc., until all the paths in RPT are node-disjoint.

The above node-disjoint selection allows us to obtain a much more simplified routing path table. Every path in the table is node-disjoint with the others and the paths are in an ascending number according to their FCs.

There are usually more than three routing paths in the RPT even after the node-disjoint selection scheme, if we consider all these paths, the efficiency of the algorithm will decrease.

Therefore, one can just take the first  $p \geq 2$  routing paths. We shall first consider the case of two multiple paths in order for us to understand fully the benefits of our bandwidth allocation algorithm. Then we will extend our study to three and more paths in order to demonstrate the compatibility of our optimization model.

### 3.3.3 The Updated Optimization Formulation

Having discussed the new FC equation (Section 3.3.1) and introduced node-disjoint paths for RPT (Section 3.3.2), we can now update/improve our GANFA algorithm of Section 3.1.3 as follows.

For each of the  $p$  ( $p \geq 2$ ) multiple routing paths selected in Section 3.3.2, let  $C_{max}^C$  be the maximum available capacity of the Crowded Node C that is shared by the intersecting paths from various transmission sources. Let  $X_{SC}$  represent the bandwidth to be allocated to this path, and let  $FC_{SC}$  represent its FC as given in eqn. (3-6). Since different allocation scheme (different values of  $X_{SC}$ ) can obtain different weighted sum, we let  $U$  be the total flow cost as a weighted sum of all  $FC_{SC}$  selected in the RPT from all source nodes under consideration. Our aim is to find an allocation scheme so that the Total Flow Cost is the minimum. Thus our objective function for optimum bandwidth allocation is formulated as follows.

$$\text{Minimize } U = \sum_{S,C \in M} U_{SC} * \frac{X_{SC}}{C_{max}^C} * X_{SC} \quad (3-7)$$

Subject to:

$$\sum_S X_{SC} < C_{max}^C, \forall S \in M \quad (3-8)$$

$$\sum_C X_{SC} \geq D_S, \forall C \in M \quad (3-9)$$

$$X_{SC} \geq 0 \quad (3-10)$$

In the optimization process of the limited bandwidth allocation at the  $p$  CNs, we also have to be globally-aware of the traffic condition and bandwidth usage of other intersecting flows converging from anywhere in the network. This is done by using different values of  $X_{SC}$  so that the flow costs weighted by the utilization give the minimum total costs. As introduced in the beginning, utilization is a good indicator for queueing delay (although there can be other factors contributing to the delay). Therefore, we shall use utilization factor combined with  $FC_{SC}$  to measure the weight of bandwidth allocation. Note that in (3-7),  $X_{SC}$  is reused in  $X_{SC}/C_{\max}^C$  as a weight to the Flow Cost of  $U_{SC}$ . These two components combined together to be a new Flow Cost. The more bandwidth allocated to one path ( $X_{SC}$ ), the higher the new combined flow cost (also higher queueing delay). Different allocation scheme (using different values of  $X_{SC}$ ) can result in different weighted sums. Our optimization is to find the optimal allocation scheme so that the Total Flow Cost is minimum.

Constraint (3-8) says that the sum of arrival rates from all network flows cannot exceed the maximum capacity (data rate) of a CN. Constraint (3-9) says that the sum of all outgoing path capacities supporting the flows from the same source should be greater than the source data rate. It also ensures that at least one  $X_{sc} > 0$ . Constraint (3-10) is just a regular condition to ensure the non-negativity of a flow value.

In summary, the purpose of this optimization is to jointly consider all the network flows going through the CNs for the optimization of a particular path. It then chooses the best bandwidth allocation  $X_{sc}$  for each flow from source  $S$  going through the crowded node  $C$ . The results of the optimization would allow us to choose the best bandwidth allocation scheme among all paths between a source-destination pair. We shall test this new optimization in a large network in the next section.

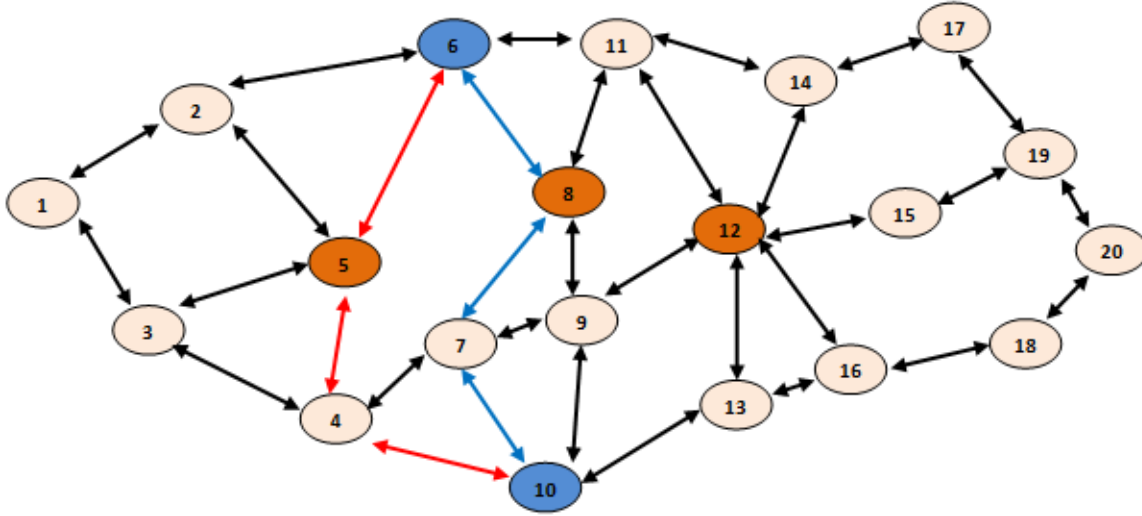
### 3.3.4 The Updated Algorithm Design

The updated GANFA algorithm is as the following.

- 1) Obtain all the routing paths for the present transmissions in the network and save them in the RPT.
- 2) Renew and simplify the RPT according to the following schemes:
  - a) Compute the FC of each path.
  - b) Update all paths of the RPT based on their FC values in an ascending order.
  - c) Choose the node-disjoint paths to cut down the RPT size.
- 3) Select  $p \geq 2$  multiple paths according to the requirement.
- 4) Identify the Crowded Nodes for each of the  $p$  paths in the RPT.
- 5) Identify all the other transmissions sharing the Crowded Nodes and their data rates.
- 6) Carry out the optimization in Chapter 3.3.3 to obtain the optimal bandwidth allocation to each transmission converging in the Crowded Nodes.

### 3.4 Optimization Performance Evaluation

Fig.3-5 shows an example of  $n=20$  node network, with which we shall study different cases of  $p$  parallel paths. We will firstly study  $p=2$  which means there are two multiple parallel paths for each transmission. Then we are going to study more than 3 paths for the transmission to evaluate the capacity of our algorithm. Since we mainly want to illustrate the optimization process here, we did not show the very detailed information how to select the multiple paths in this example. So we just assume two paths have been found..



**Fig.3-5: A 20-Nodes Network Example**

### 3.4.1 Two Multiple Paths

We first use  $p=2$  parallel paths to demonstrate how two transmissions interact with each other. One transmission goes from source node 6 to destination node 10. As shown in Fig.3-5, there are two node-disjoint multiple routing paths: the path 6-5-4-10 is shown in red and has the smallest FC value while the path 6-8-7-10 is shown in blue with the second smallest FC value. The second transmission goes from source node 11 to destination node 4. It also has two node-disjoint paths of 11-6-5-4 and 11-8-9-7-4.

**Table 3-4: Sample Data for 1st Transmission**

Source Node 6 to Destination Node 10 Ds=60 kbps	CNs	$C_{max}^C$	$\frac{H_i}{n-1}$	$\frac{P_T}{P_{vu}}$			$\frac{D_{vu}}{D_{max}}$		
6 - 5 - 4 - 10	5	80 kbps	3/(20-1)	Links in the routing path			Links in the routing path		
				6 - 5	5 - 4	4 - 10	6 - 5	5 - 4	4 - 10
				0.48	0.67	0.11	0.45	0.25	0.05
6 - 8 - 7 - 10	8	70 kbps	3/(20-1)	Links in the routing path			Links in the routing path		
				6 - 8	8 - 7	7 - 10	6 - 8	8 - 7	7 - 10
				0.61	0.56	0.79	0.14	0.22	0.25

Table 3-4 illustrates the values of different components to be used in eqn. (3-6) for the first transmission. Here, we use  $P_T= 100 \text{ mW}$  and  $D_{max}= 100\text{ms}$  to normalize the components. We assume source node 6 is transmitting data at a rate of 60 Kbps. Furthermore, Node 5 is assumed to be the CN identified in the first path with the lowest available bandwidth of 80 kbps. Likewise, Node 8 is identified as the CN for the second path with the lowest bandwidth of 70 kbps. The hops for both paths are 3 and the maximum hop distance is  $n-1=19$  as reflected in the 4th column of  $H_i/(n - 1)$ .

The values of  $P_T/P_{vu}$  in the 5<sup>th</sup> column are all normalized with respect to the power threshold for use in eqn. (3-6). For example, suppose the total remaining power of link 6-5 is  $P_{vu}= P_{65}=222 \text{ mW}$ , one obtains the normalized number of 0.45 as shown, and likewise for all normalized numbers indicated for links (5,4), (4,10), (6,8), (8,7) and (7,10).

The entries of  $D_{vu}/D_{max}$  in the 6<sup>th</sup> column are also normalized numbers. For example, if  $D_{68}=14 \text{ ms}$  is measured for link (6,8), then we obtain the normalized value of 0.14. This is done similarly for other links of (6,5), (5,4), (4,10), (8,7) and (7,10).

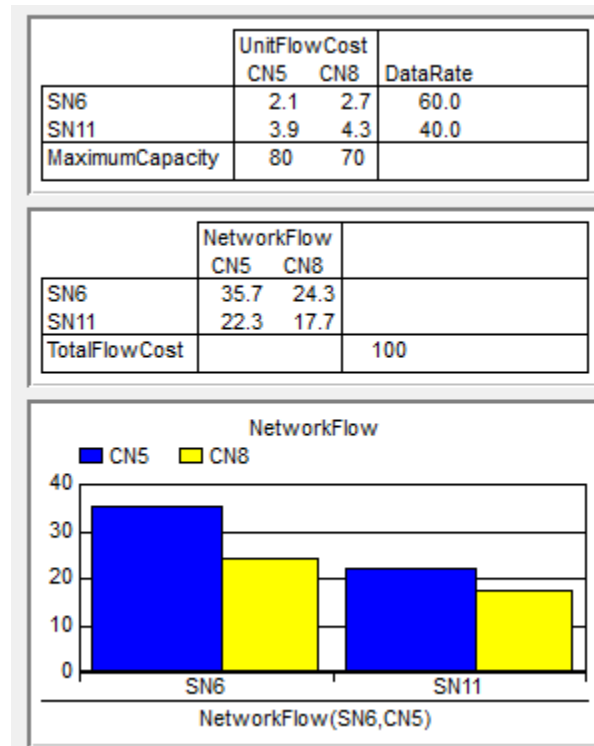
**Table 3-5: Sample Data for 2nd Transmission**

Source Node 11 to Destination Node 4 Ds=40 kbps	CNs	$\frac{H_i}{n - 1}$	$\frac{P_T}{P_{vu}}$				$\frac{D_{vu}}{D_{max}}$			
11 - 6 - 5 - 4	5	3/(20-1)	Links in the routing path				Links in the routing path			
			11-6	6-5	5-4	11-6	6-5	5-4		
			0.98	0.48	0.67	0.92	0.45	0.25		
11 - 8 - 9 - 7 - 4	8	4/(20-1)	Links in the routing path				Links in the routing path			
			11-8	8-9	9-7	7-4	11-8	8-9	9-7	7-4
			0.64	0.58	0.75	0.62	0.33	0.27	0.45	0.47

Similarly, Table 3-5 shows the values of different components to be used in eqn. (3-6) for the second transmission with source node 11 transmitting at 40Kbps. To illustrate the process of

optimization in bandwidth allocation, we assume the two parallel paths have the same CNs (Nodes 5 and 8) as the first transmission from node 6 to node 10, and hence the same  $C_{max}^C$  values used in Table 3-4.

Note that the second path has  $n=5$  nodes (4 hops) which is bigger than the hop counts of other paths in Tables 3-4 and 3-5. This is reflected in the calculation of  $H_i/(n-1)$ . Again, our  $P_{vu}$  and  $D_{vu}$  values are normalized under the  $P_T/P_{vu}$  and the  $D_{vu}/D_{max}$  columns in the table similar to Table 3-4. Using the same  $P_T=100\text{ mW}$  and  $D_{max}=100\text{ms}$  as in Table 1, the total remaining power of link 11-6 is  $P_{vu}=P_{116}=131\text{mW}$ , which gives the normalized number of 0.76 as shown. Similarly the measured delay of  $D_{116}=33\text{ ms}$  for link (11, 6) gives the normalized value of 0.33. Likewise this is done for all the other links.



**Fig.3-6:Optimal Allocation Result for Two Paths**

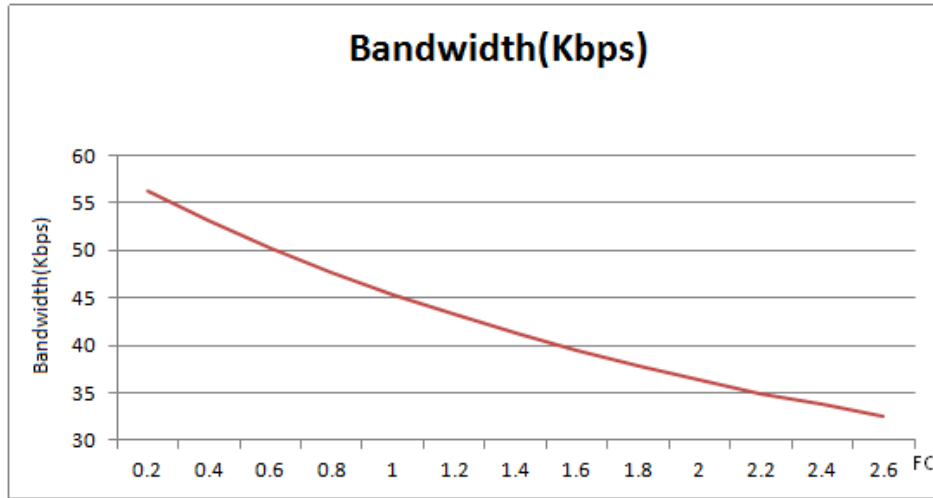
We can now globally optimize the bandwidth allocation among all 4 routing paths based on the information in Table 3-4 and Table 3-5. Fig.3-6 shows the allocation results after running our optimization model in AIMMS. We can see that the Flow Cost for the two paths of the transmission from SN6 (Source Node 6) are 2.1 and 2.7, and those for transmission from SN11 (Source Node 11) are 3.9 and 4.3. Based on these FCs, the optimum allocation scheme is obtained at the minimum total flow cost of 100. The allocation for each flow is also presented in the bar chart. One can check that the total bandwidth (blue and yellow) allocated for Source Node 6 should be equal to or larger than the source data rate requirement of 60 kbps. Similar comment goes to Source Node 11 whose requirement is 40Kbps. On the other hand, the total bandwidth allocated to the flows from SN6 and SN11 should be less than or equal to the bandwidth available from CN5. Likewise check that CN8 has adequate bandwidth available.

**Table 3-6: Other Random Allocation Schemes**

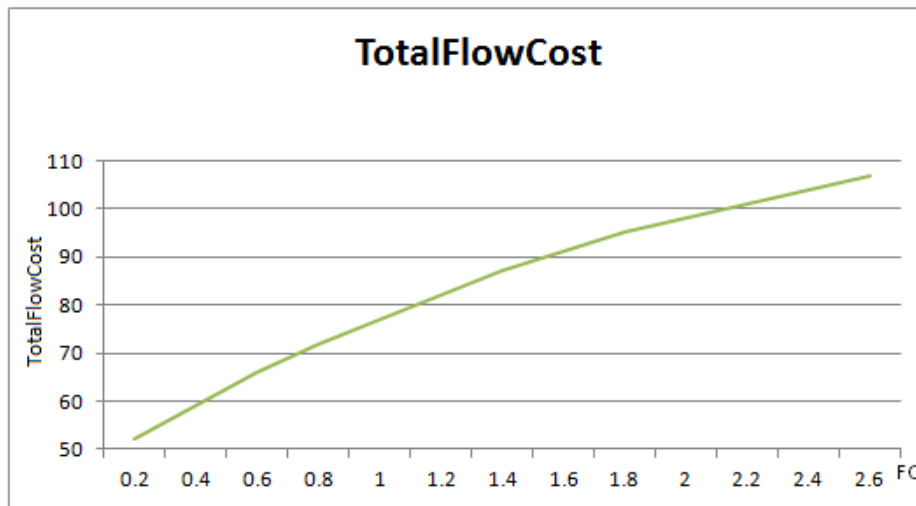
Diff Bndwidth AllctnSchms	#1		#2		#3		#4		#5		#6	
	CN5	CN8	CN5	CN8	CN5	CN8	CN5	CN8	CN5	CN8	CN5	CN8
SN6	20	40	35	25	50	10	27	33	15	45	30	30
SN11	20	20	15	25	10	30	16	24	30	10	28	12
TotalFlowCost	116		106		130		109		134		105	

In order to verify the optimality of our result, Table 3-6 gives 6 different schemes where bandwidths are allocated randomly to the congested nodes. Take Allocation #1 for example, the row of SN6 says that one wants to allocate bandwidths 20 kbps and 40 kbps to the paths going through CN5 and CN8 respectively. Similarly, the row of SN11 says that bandwidths 20 kbps and 20 kbps are allocated to paths going through CN5 and CN8 respectively. The total flow cost is 116. The total flow costs of other random allocation schemes (#2 to #6) are all bigger than our optimum result of 100 as well when using the same FC assignments from Tables 3-4 and 3-5.

The optimization exercise in Table 3-6 above suggests that the FC of a path can play an important role in the behavior of various performance measures. For Fig.3-7 to Fig.3-10 below, we shall vary the FC of the first path while keeping the FC of the other 3 paths the same.



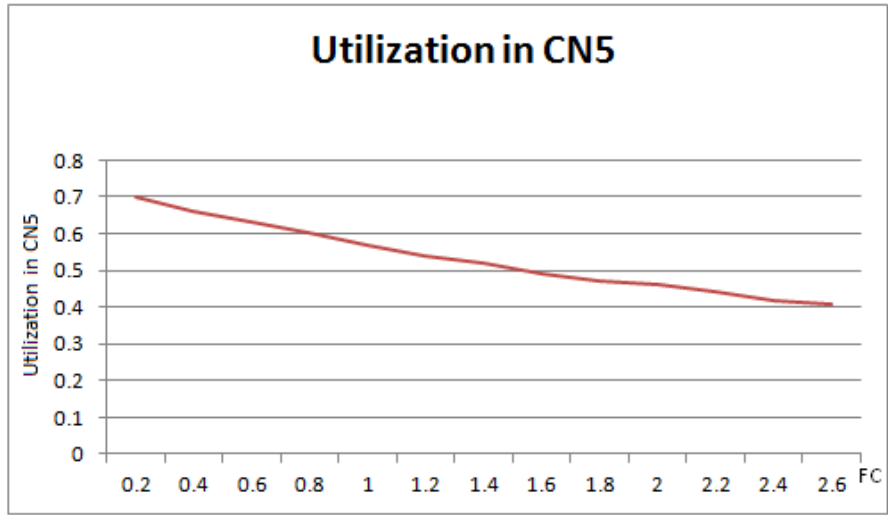
**Fig.3-7: Relationship between FC and Bandwidth**



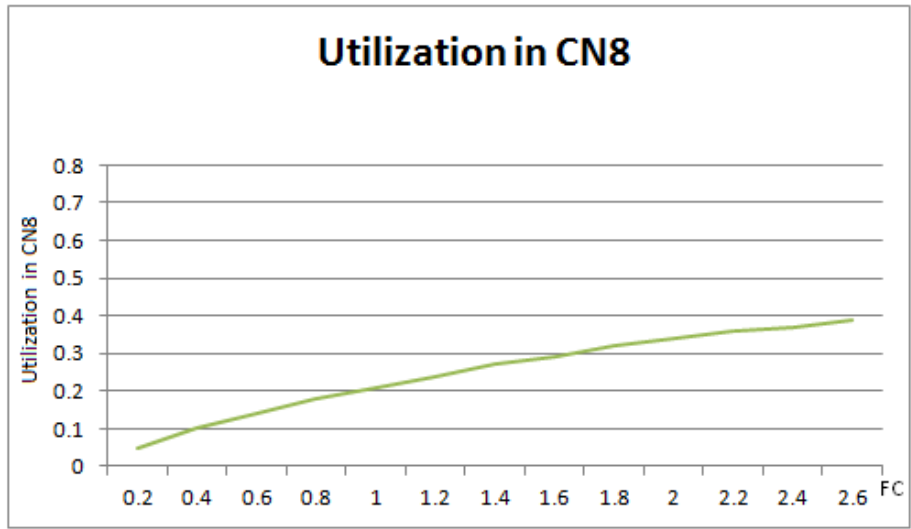
**Fig.3-8: TotalFlowCost of All Paths vs Cost Assignment of One Path**

Fig.3-7 considers the transmission from Source Node 6 to Crowded Node 5. As the FC of the first path deviates from the current value of 2.1, the optimally allocated bandwidth is decreasing non-linearly. Fig.3-8 shows that the “smallest total network FCs” (based on the unit

FCs assigned to the 4 paths) is increasing non-linearly with respect to the FC value of the first path. In general, the larger the FC value of a path while keeping others the same, the higher the Total FC value.



**Fig.3-9: Relationship between FC and Utilization in CN5**



**Fig.3-10: Relationship between FC and Utilization in CN8**

Fig.3-9 shows that the utilization of CN5 is a decreasing function of increasing FC assigned to the first path. This is due to the decrease in the allocated bandwidth to that path as

shown in Fig.3-7. According to the general queueing theory, we would expect the queueing performance to improve as the FC increases. For example, as less packets are transmitted through CN5, its queueing delay would decrease. On the other hand, Fig.3-10 shows that the utilization of CN8 is an increasing function of the FC which means the queueing performance would worsen. This is due to more packets transmitted through CN8 in order to meet the constraint (3-9) in Section 3.4.2 of our optimization model.

### 3.4.2 More than Two Multiple Paths

Our algorithms can also perform optimum bandwidth allocation to three or more paths. We offer below another example with  $p=3$  multiple routing paths for each transmission.

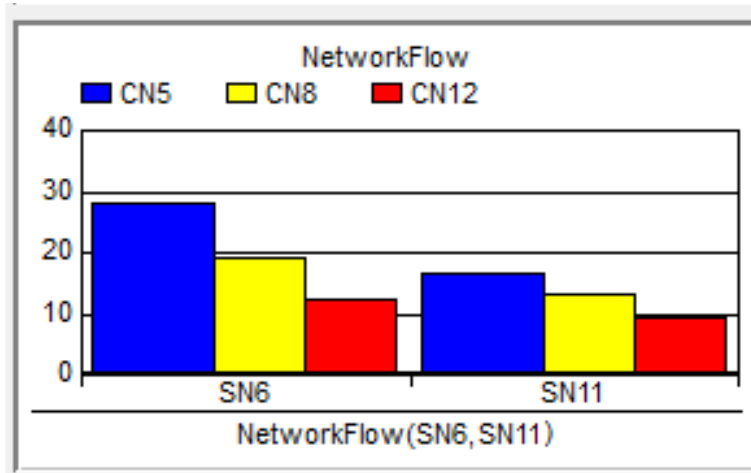
**Table 3-7: Information for Third Path**

The 3rd Path	CN	$C_{max}^C$	$\frac{H_i}{n-1}$	$\frac{P_{vu}}{P_{max}}$				$\frac{D_{vu}}{D_{max}}$			
<i>6-11-12-9-10</i>	12	60Kbps	4/(20-1)	Links in the routing path				Links in the routing path			
				<i>6-11</i>	<i>11-12</i>	<i>12-9</i>	<i>9-10</i>	<i>6-11</i>	<i>11-12</i>	<i>12-9</i>	<i>9-10</i>
				0.57	0.64	0.7	0.45	0.11	0.24	0.37	0.19
<i>11-12-13-10-4</i>	12	60Kbps	4/(20-1)	Links in the routing path				Links in the routing path			
				<i>11-12</i>	<i>12-13</i>	<i>13-10</i>	<i>10-4</i>	<i>11-12</i>	<i>12-13</i>	<i>13-10</i>	<i>10-4</i>
				0.66	0.72	0.79	0.81	0.44	0.35	0.57	0.63

Table 3-7 gives the parametric information of additional paths added to the two transmissions in the same 20-node network of Fig.3-5. Specifically, we have *6-11-12-9-10* as a third path for the transmission between SN6 and DN10 (Destination Node 10) while *11-12-13-10-4* is the third path for transmission between SN11 and DN4. For illustration purpose, we shall use Node 12 as the additional CN with a maximum capacity of 60 Kbps. The data rates of the two sources remain the same at 60Kbps and 40 Kbps respectively. We also use the same

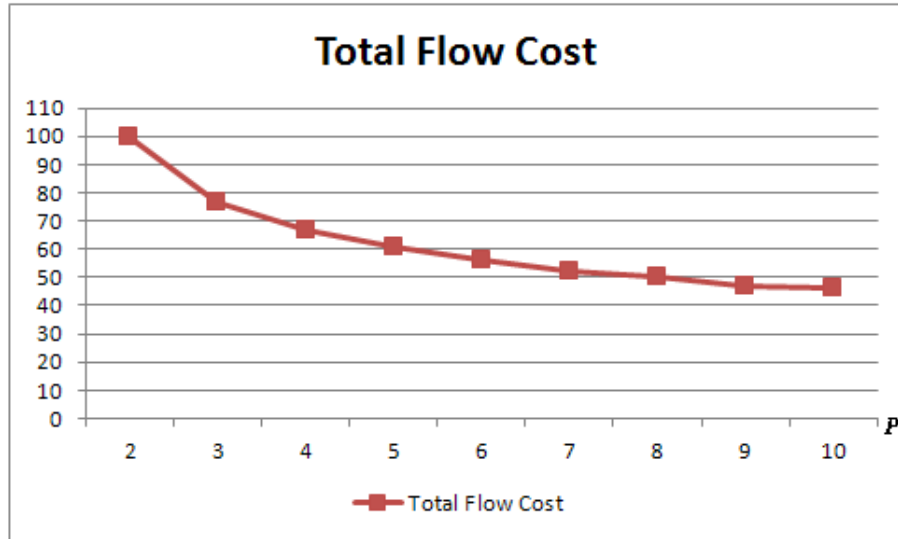
information for the other two paths in Tables 3-4 and 3-5. Altogether there are 6 paths to consider with 3 paths each to the modified Tables 3-4 and 3-5.

We can now run our optimization model to obtain the optimum allocation for each of the 6 paths. The FC values for the additional paths are 3.5 for SN6 and 5.2 for SN11 based on the information of Table 3-7, while the FCs for the original 4 paths remain the same.



**Fig.3-11: Bandwidth Allocation Result for 3 Multiple Routing Paths**

Fig.3-11 shows the results of the optimum bandwidth allocation. Compared with Fig.3-6, the allocated bandwidth for the first path is reduced from 35.7 Kbps to 28.2 Kbps, and the second path is reduced from 24.3 Kbps to 19.2 Kbps. The total allocated bandwidth remains the same at 60 kbps. Obviously, our algorithm has successfully changed the distribution from two paths to three paths, with the third path (through CN12) providing the extra bandwidth of 12.7 kbps. Similar observation and explanation go to the bandwidth allocation for the traffic requirement of 40 kbps from SN11. One also sees that using a total of 6 paths to carry the traffic of 2 transmissions has reduced the TFC(Total Flow Cost) from 100 to 77. All these changes are due to the additional third path for each transmission. We have also tried some other random allocation schemes as done in the two-path study, and their results (not shown here) demonstrate that TFC of 77 we obtained above is the minimum.



**Fig.3-12: Relationship between the Total Flow Cost with the Number of Paths P**

One of the advantages of our algorithm is that it can provide bandwidth allocation for any number of  $p$  paths. This allows us to study easily the effect of providing more paths and transmission. For example, using  $p=4$  multiple paths reduce the (smallest) TFC to 67. The marginal gain (reduction in this total flow cost) is not as much as before. In fact, from the curve of the Total Flow Cost with respect to  $p$  in Fig.3-12, one sees the marginal reduction is ever decreasing. Depending on the requirement of network design, there is a certain threshold (say  $p=5$ ) beyond which there is not much more advantage. The limit can be used to cut down the amount of computation in optimization when deciding the number of parallel paths to achieve a given performance measure.

### 3.4.3 Comparison of the Two Algorithms

The GANFA and Updated GANFA are both about the bandwidth allocation optimization. The later one is better than the first one. We can see the comparison between the two algorithms in Table 3-8.

**Table3-8: Comparison of Two Algorithms**

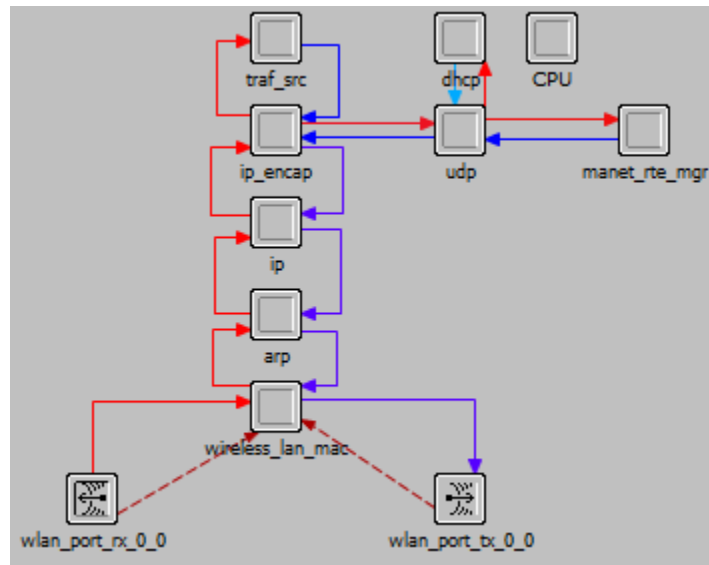
Comparison	GANFA	Updated GANFA
Network Scale Capability	Works well for small networks	Can handle big networks
Objective Function	Simple	More complex
Queueing performance	Not considered	Considered
Crowded Nodes	Assumed known	Selected
Extension	No	Yes

### 3.5 Performance Comparison in OPNET

We shall use OPNET to investigate the queueing performance of a network using our algorithms.

#### 3.5.1 Simulation Implementation

We have also implemented the algorithm in Section 3.4 using OPNET 14.5.



**Fig. 3-13: Node Model**

Fig.3-13 shows the node model/implementation of a MANET (Mobile Ad hoc NETWORK) station that we have modified from the OPNET library. The model consists of interconnected blocks called modules. Each module contains a set of inputs/outputs, and a process/method (not shown) for computing the outputs of a module from its inputs and from its state memory (also

not shown). Each module implements an entity of a protocol layer. The entity “wlan\_port\_rx/tx\_0\_0” implements the receiver and transmitter in the Physical Layer by taking the output/input from/to the MAC layer entity “wireless\_lan\_mc” for transmission in the wireless medium. Entities “arp”, “ip” and “ip\_encap” implement the Network Layer functions related to TCP/IP while other entities are data from different sources in the upper layers. The most interesting entity pertinent to our research is the “manet\_rte\_mgr”. This is the MANET Routing Manager entity which can implement different routing protocols. Our algorithms in Section 3.3 are coded in here as a new process.

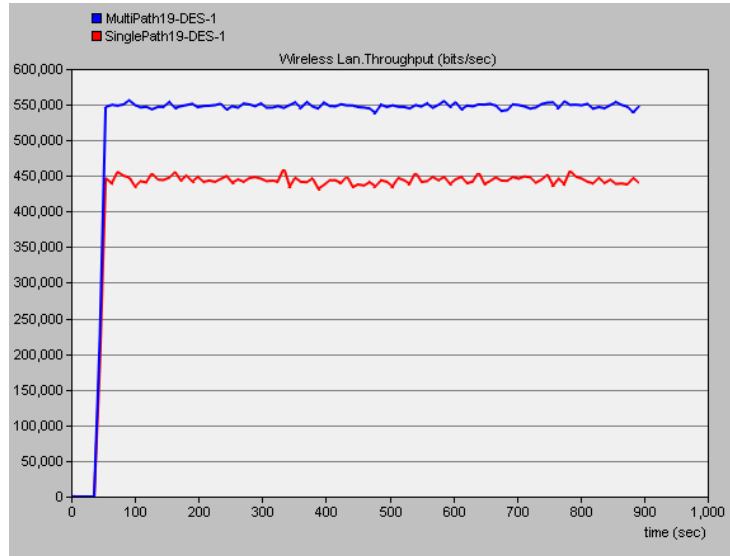
### 3.5.2 Performance Results Analysis

To verify our performance improvement, we have created a wireless ad hoc network model with nodes running TCP/IP. There are  $n=10$  randomly placed nodes within the 500m\*500m area. As an initial investigation, we make the nodes stationary.

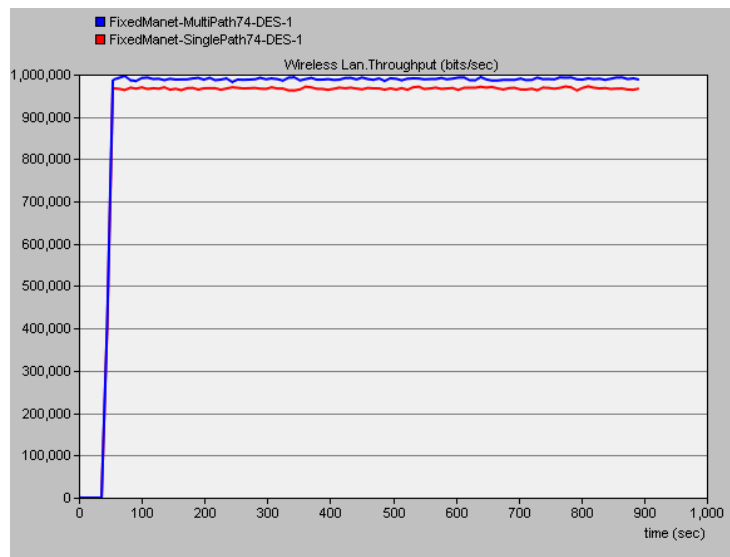
In this simulation, we use two transmission flows ( $1 \rightarrow 9$  and  $7 \rightarrow 4$ ), each of which has  $p=2$  node-disjoint paths. As expected, our optimization algorithm in the “manet\_rte\_mgr” entity shown in Fig.3-13 will globally analyze the FC of each path and then get the optimum allocation scheme. Our performance improvement demonstration is done in two parts: first comparing the throughput performance (without using optimization) of two paths within a single transmission, and then comparing the performance of the same transmission with and without optimization.

For the implemented OPNET simulator with  $p=2$ , Fig.3-14 shows the instantaneous throughput (in bps) as time evolves when data is arriving at Source Node 1 at a rate of 1000 packets/s. Using a constant packet length of 1000 bits, the arrival rate of 1000 packets/s is equal to 1000000 bps. The red curve is the throughput of a single path using AODV while the blue

shows total throughput of the two paths in our multipath routing without using optimization. We can see the steady throughput has increased from 450000 bps to 550000bps (which is an improvement of 100000bps or 22.2%). Packets are lost due to the limited buffer size and/or some other reasons. Note the simulator has allowed the first 50 seconds for the system to perform routing discovery.

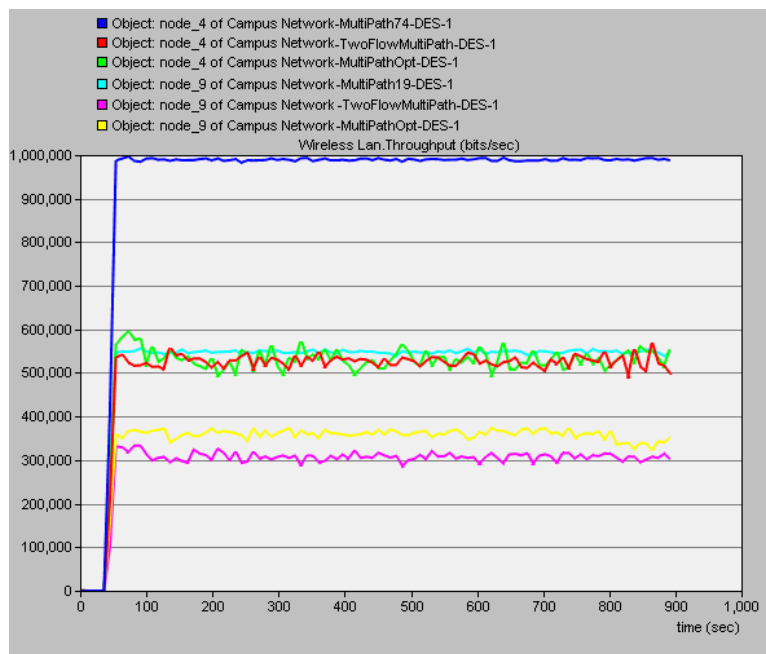


**Fig.3-14: Throughput Comparison for Path from Source Node 1 to Destination Node 9**



**Fig.3-15: Throughput Comparison for Path from Source Node 7 to Destination Node 4**

Similar to Fig.3-14, Fig.3-15 compares the instantaneous throughput of the transmission from source node 7 to destination node 4 using the same arrival rate and packet size. Higher throughput is achieved here due to shorter length (measured in hops) and higher bandwidth of the path. One can see the steady-state throughput is increased from 980000 bps for the single path case (shown in red) to 990000 bps for the multiple path case (shown in blue), which is ~1% improvement. The improvement percentage is less because the path is already supporting a throughput very close to the arrival rate.



**Fig.3-16: Throughput Comparison**

Figs.3-14 and Fig.3-15 investigate the same scenario where only one source-destination transmission flow is considered separately. We now investigate the throughput when the two source-destination flows (1→9 and 7→4, and each with 2 multiple paths to its destination.) are transmitting at the same time. Nodes 3 and 8 are the crowded nodes where these paths intersect. Without using any bandwidth optimization, Fig.3-16 shows the total throughput of each transmission actually drops. For examples, the throughput of transmission flow 1→9 has decreased from about 550000 bps (shown in light blue) to 300000bps (shown in pink) while the

throughput of flow 7→4 has decreased from about 990000 bits/sec (shown in dark blue) to 520000 bits/sec (shown in red). This is because the limited bandwidth in Crowded Nodes 3 and 8 are not properly shared/allocated among the multi-paths supporting the two source-destination flows and therefore congestion has occurred.

After applying our optimization algorithm, the throughput for the flow 1→9 has increased from 300000 bits/sec (shown in pink) to 370000 bits/sec (shown in yellow) while the second flow 7→4 has increased from about 520000 bits/sec (shown in red) to 530000 bits/sec (shown in green). This demonstrates that our optimization can improve the throughput and therefore decrease the impact of congestion. The improvement for the 7→4 flow is not as big indicating congestion is still present. The observation is that our optimization can improve congestion via the optimization of bandwidth allocation but not built to solve the congestion problem.

### **3.6 Concluding Remarks**

In this chapter, we first presented an optimization algorithm called GANFA which is globally aware of the interactions with transmissions from other parts of the network. We used a simple example to illustrate the related concepts and process. As an improvement, we have updated the algorithm by taking queueing performance into account via the utilization factor, and increasing its efficiency by using node-disjoint multiple paths in the RPT. We formulated the FC calculation by including a weight factor for each parameter so that the impact of power, delay and hop count can be adjusted if it is necessary. We offer an example to evaluate the related performance and use AIMMS to obtain the optimization results. Then we apply the optimization results into OPNET14.5 to do a performance comparison. The simulation results show that our algorithm can improve the throughput.

## **Chapter 4**

### **AOMDV Routing based on FC in Dynamic MANET**

Unlike the static network in Chapter 3, the topology of a MANET is dynamic because its nodes are moving randomly in most applications. Therefore the proposed bandwidth allocation algorithm in Chapter 3 would not be adequate. In this chapter, we shall use alternate multipath routing which means choosing a primary routing path for transmitting and preparing one or more back-up alternate path at the same time; when the primary path failed, the alternate path will directly be used to continue the transmission. Our algorithm selects paths based on Flow Cost, and hence the name FC-AOMDV (Ad hoc On-demand Multipath Distance Vector routing based on Flow Cost). We shall compare our FC-AOMDV with the traditional AODV algorithm to investigate the improvement of delay, throughput and packet delivery ratio.

#### **4.1 AODV and AOMDV**

We shall first summarize the essential features of AODV [BiKh10, MaMa14] and AOMDV[BhAa16] that we use in their extension to our FC-AOMDV.

The AODV protocol is a pure on-demand routing protocol because a mobile node does not have to maintain any routing information if it is not located in an active path. The AODV protocol usually consists of a route discovery and a route maintenance mechanism as introduced in Section 2.2.

In essence, the AODV combines the use of destination sequence number in DSDV with the on-demand route discovery technique in DSR to formulate a loop-free and on-demand single path. Unlike DSR which is source routing, AODV uses a hop-by-hop routing approach. Being a single-path on-demand routing protocol AODV has to go through a new route discovery in

response to every route break. This becomes a problem when each route discovery is associated with high latency. This inefficiency is avoided in AOMDV [BhAa16] when all available redundant paths can be determined at the same time.

To keep track of multiple routes, the routing entries for each destination contain a list of the next-hops along with the corresponding hop counts. All the next hops have the same sequence number. For each destination, a node maintains the advertised hop count, which is defined as the maximum hop count for all the paths. This is the hop count used for sending route advertisements of the destination. Each duplicate route advertisement received by a node defines an alternate path to the destination. To ensure loop freedom, a node only accepts an alternate path to the destination if it has a lower hop count than the advertised hop count for that destination. Because the maximum hop count is used, the advertised hop count therefore does not change for the same sequence number. When a route advertisement is received for a destination with a greater sequence number, the next-hop list and advertised hop count are reinitialized.

As an extension of AODV, when AOMDV builds multiple paths, it will select the main path for data transmission which is based on the time of routing establishment. The earliest one (smallest end-to-end delay) will be regarded the best one and only when the main path is break other alternate multi-paths can be effective.

In summary, AOMDV has extended the AODV protocol by computing multiple loop-free paths that can be very useful in highly dynamic ad hoc networks where link failures and route breaks occur frequently. However, a lot of studies have proved that the aforementioned AOMDV scheme is not necessarily the best path[ZhXu13]. Below is an improvement design for our applications in this thesis.

## 4.2 Design of FC-AOMDV

To improve its performance, we proposed our FC-AOMDV which is short for "AOMDV based on Flow Cost". In our protocol, we introduce the Flow Cost to improve AOMDV's performance in selecting main path. During the routing discovery process, the routing update rule calculates the Flow Cost of each path and then sorts it by ascending order in the routing table, and we choose the path with smallest FC value as the primary path for data transmission. The path with the second smallest FC value is chosen as the back-up path. In this way, the best path is a path with a comparatively low latency, low power consumption and smaller hop count. The related information about FC has been introduced in Chapter 3. Also no Crowded Nodes are used here for optimization, as we are mainly concerned with the influence of node moving speed.

The steps for FC-AOMDV are as below:

- 1) Get all available paths through the routing discovery and save them in the RPT.
- 2) Compute the Flow Cost based on the equation (3-6) in Chapter 3 for each of the path.
- 3) Update all paths in the RPT in an ascending order based on the FC.
- 4) Use the node-disjoint method in chapter 3 to simplify the RPT.
- 5) Select the first row of RPT as the main path and the second one as the alternate multiple path.

When the main path has a link breakage, the second one will be directly used for the transmission.

## 4.3 Performance Evaluations

We will first do some basic performance evaluations and comparisons via OPNET 14.5 simulation. Since the performance may be different between a small network and a larger network, generally speaking, higher node density usually means more available better routing

paths, thus we will do both to do the comparison. We are going to choose a small network with only 10 nodes and a larger network with 100 nodes to see the improvement of our algorithm in the simulations.

**Table 4-1: Simulation Parameters of Small Network**

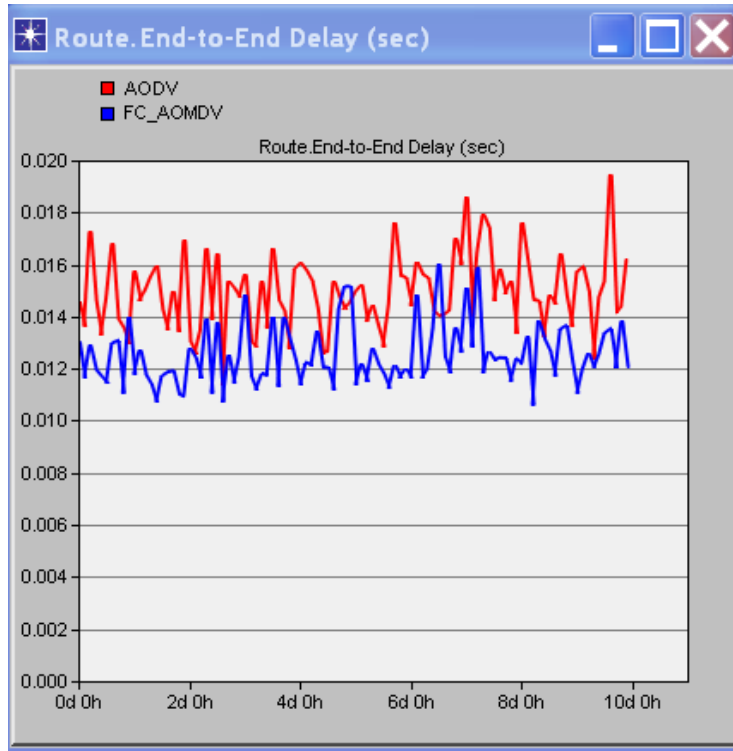
Parameters	Value
Moving Area	100m*100m
Number of Nodes	10
Antenna Type	Omni-directional
Default Packet Size	128 bytes
Default Packet Arrival Rate	100 packets/sec
Default Simulation Seed	127
Simulated Time	10 days
Transmission in Network	Node 1 -> Node 10
Mobility Model	RWM
Default Node Speed	5 m/s

#### 4.3.1 A Small Network

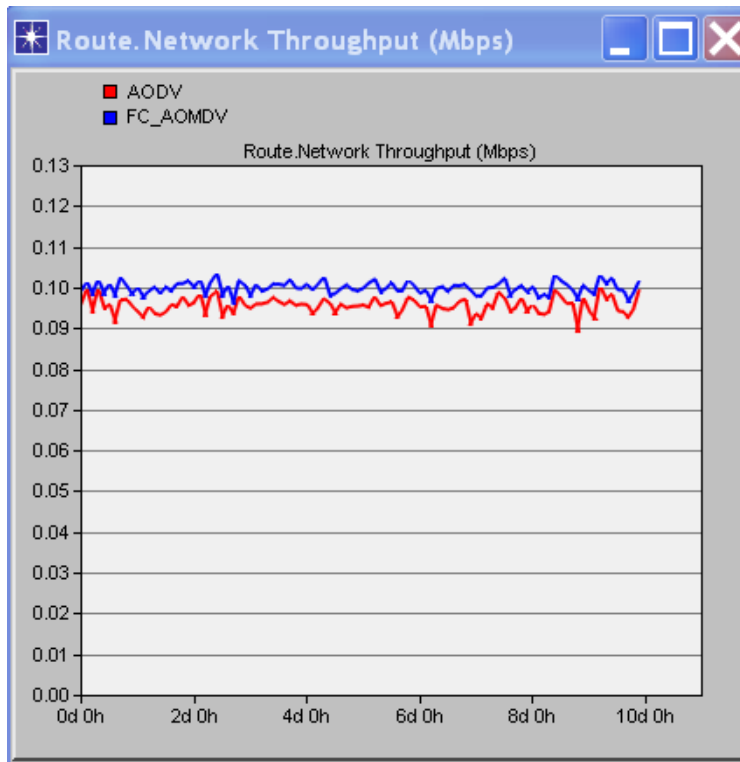
Table 4-1 gives the parameters of a network of 10 nodes, each with a transmission 20 m. The nodes are moving randomly at a speed of 5 m/s within an area of 100m\*100m. There is only one transmission (i.e. only one source-destination pair) occurring in the network.

##### 4.3.1.1 End-to-End Delay

Fig.4-1 shows the end-to-end delay for FC-AOMDV is a bit lower (about 3 ms on the average) than that of the AODV protocol. In addition to the fact that our algorithm does not depend on the shortest delay when choosing the routing path, it may also be attributed to a small routing table size and hence less computation time for the FC values. Compared with AODV, our algorithm has the alternate back-up path that can decrease the routing discovery times when link failure occurs. Overall, our algorithm can decrease the end-to-end delay although not significantly.



**Fig.4-1: End-to-End delay Comparison in Small Network**



**Fig.4-2: Throughput Comparison in Small Network**

### 4.3.1.2 Throughput

We use one second as a unit time for Throughput measurement as defined before. Fig.4-2 shows that the throughput of FC-AOMDV is better (about 10000 bits/sec more). This is due to the alternate back-up path that can be instantly used for transmission once the link breakage occurs. In this way, the transmission is more reliable and thus improving the throughput.

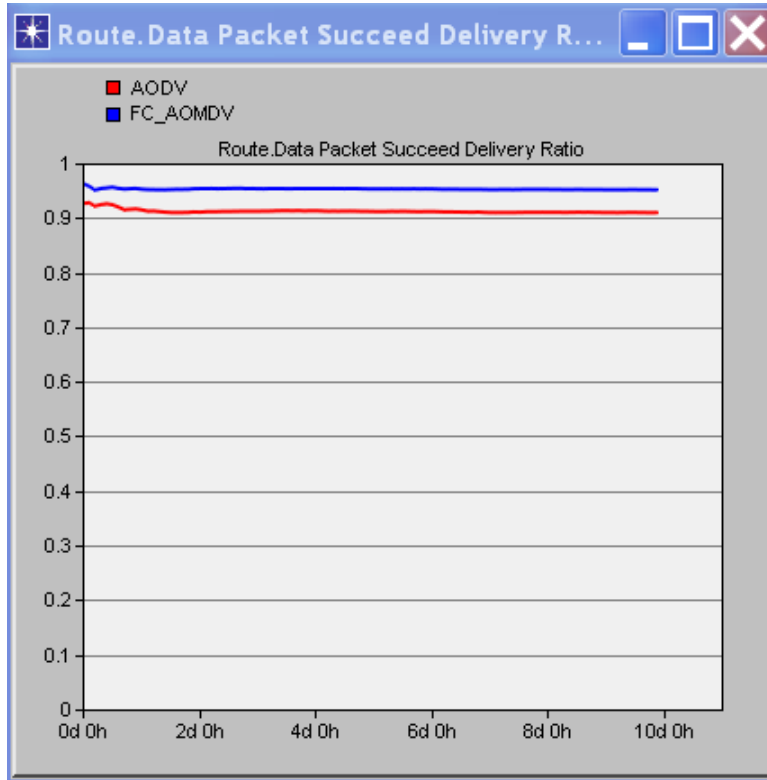


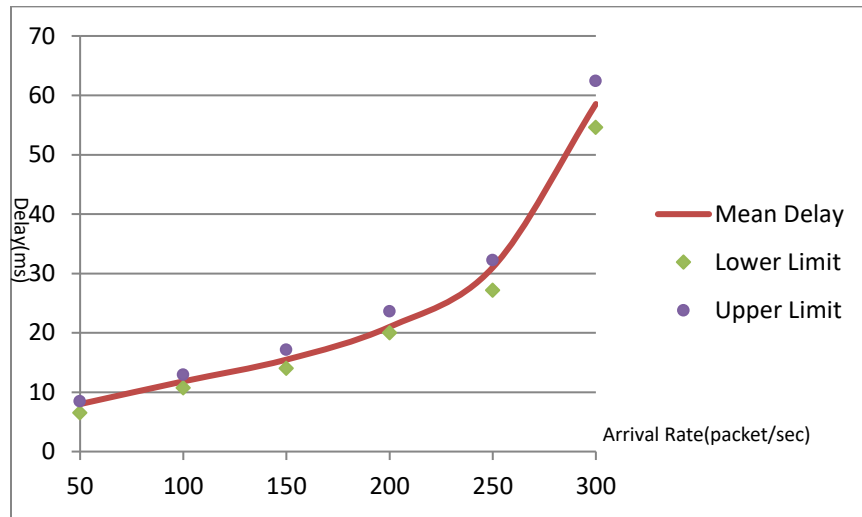
Fig.4-3: Packet Delivery Ratio Comparison in a Small Network

### 4.3.1.3 Packet Delivery Ratio

Form Fig.4-3, we can see the packet delivery ratio for the AODV is about 91%, while our FC-AOMDV can improve the ratio to about 96%. This improvement is one of the advantages for multipath routing. Dropped packets are probably due to the link failures and our multipath routing has improved its performance.

#### 4.3.1.4 Steady-State Performance

The above time-evolution performance curves also indicate the network operations under our algorithm are stable as they all settle to some meaningful values. Below we further investigate other performance measures of the network in their steady-state performance.

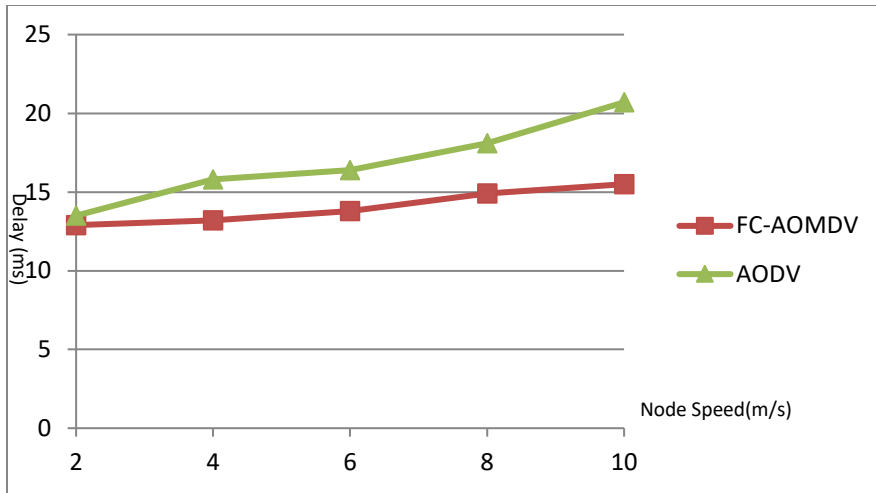


**Fig.4-4: End-to-End delay with 95% Confidence Interval**

We define the arrival rate as the average number of packets per second. From Fig.4-4, the end-to-end delay is bigger with a higher packet arrival rate at source node. This can contribute to the reason that there is an increasing queuing delay when the packet arrival rate rises. Another reason may be the higher packet loss due to buffer full with a higher arrival rate.

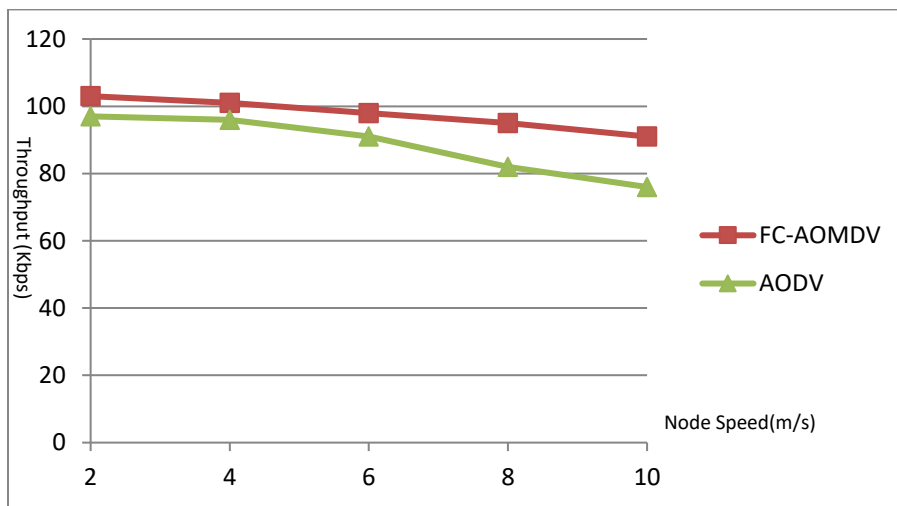
Note that we have also obtained the 95% confidence interval for the end-to-end delay vs packet arrival rate based on 5 simulation runs, each with the different seeds. For the confidence interval, we can see the upper and lower bounds are very close to the mean delay curve. Since all the other curves have the similar observations, for the purpose of clarity, we just omit them for all the other curves in this thesis.

Fig.4-1 to Fig.4-3 are based on the node moving speed of 5 m/s. We also want to evaluate our algorithm with different node speeds.



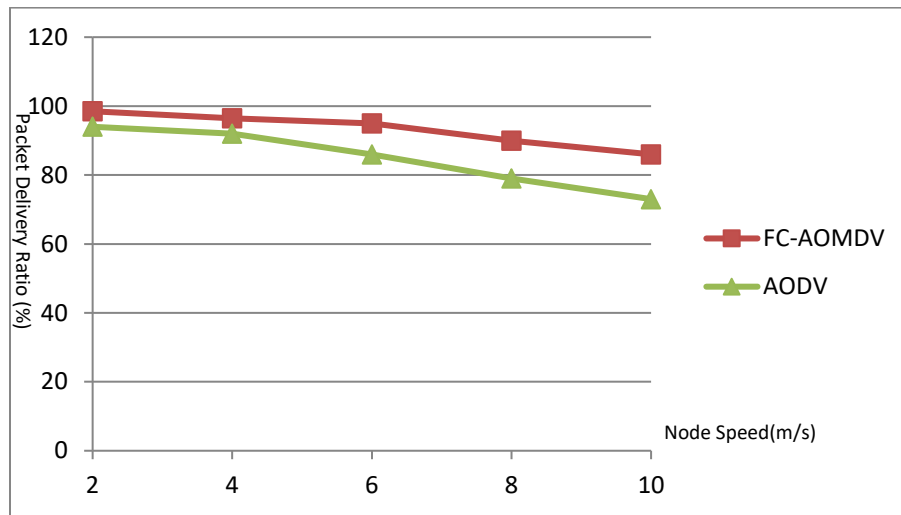
**Fig.4-5: End-to-End Delay Comparison with Different Node Speeds**

Fig.4-5 shows that the end-to-end delays of both FC-AOMDV and AODV increase with respect to increasing node speed. This is because higher moving speed can lead to more link breakages, and therefore more time required to perform route discovery. However, our FC-AOMDV algorithm can achieve a lower delay especially at high moving speeds. For example, when the speed=10m/s, our algorithm can decrease the delay as much as 5 ms. Again, the availability of alternate routes on route failures eliminates the need for the routing discovery latency when more link breakages occur at a higher moving speed.



**Fig.4-6: Throughput Comparison with Different Node Speeds**

Fig.4-6 shows that throughput is decreasing with respect to increasing moving speed. This is because more packets may be dropped due to the link breakage. However, the decrease of FC-AOMDV is not as much as AODV at higher speeds because our alternate multipath routing algorithm can instantly use the back-up path for transmission. Take the speed=10m/s for example, the throughput of our FC-AOMDV just decreased about 10 Kbps while the throughput for AODV dropped about 20 Kbps.



**Fig.4-7: PDR Comparison with Different Node Speeds**

Finally, Fig.4-7 shows that our FC-AOMDV algorithm can also achieve a better packet delivery ratio when compared with AODV. Take the speed=10m/s for example, FC-AOMDV can improve about 10% of successful delivered packets compared with AODV. This is because when the speed becomes higher and higher, nodes can easily move out of their transmission range and lead to link breakages. Under this condition, more packets are dropped that cause a decline in packet delivery ratio.

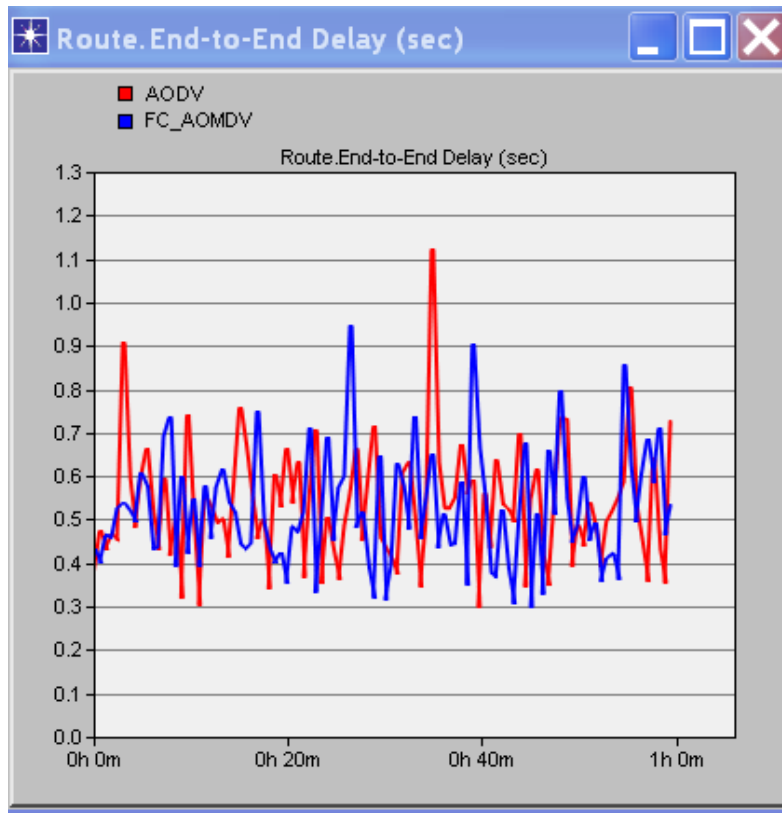
### 4.3.2 A Large Network

Table 4-2 gives the parameters of a much larger network of 100 nodes, each with a transmission

range of 200m. The nodes are moving randomly within an area of 1000m\*1000m- We assume there are two transmissions (i.e. two source-destination pairs) occurring in the network.

**Table 4-2: Simulation Parameters of Large Network**

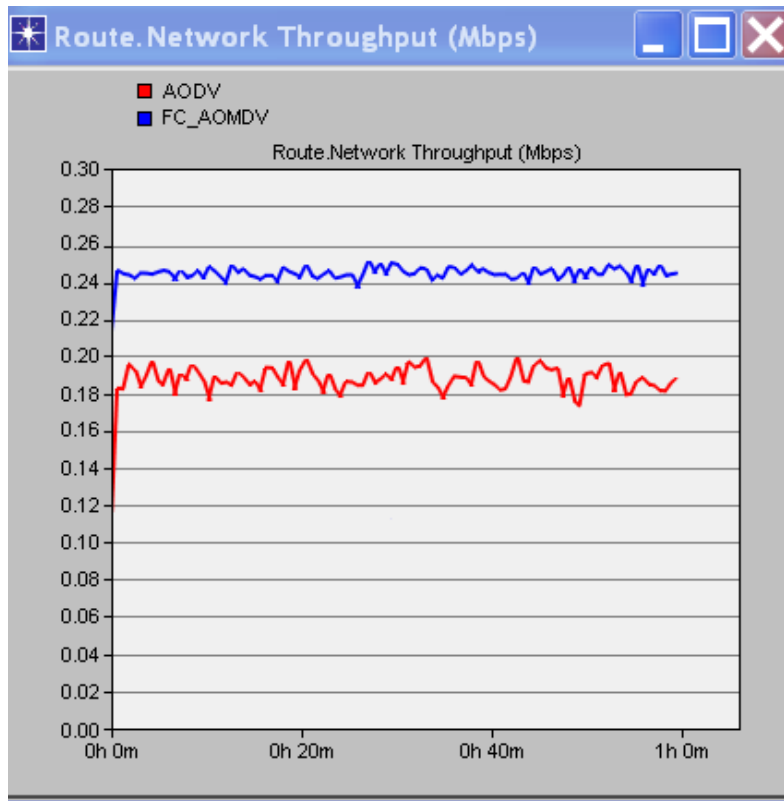
Parameters	Value
Moving Area	1000m*1000m
Number of Nodes	100
Antenna Type	Omni-directional
Default Packet Size	128 bytes
Default Packet Arrival Rate	100 packets/sec
Default Simulation Seed	127
Simulated Time	10 hours
Transmission in Network	Node1 -> Node10 & Node2 -> Node20
Mobility Model	RWM
Default Node Speed	5 m/s



**Fig.4-8: End-to-End delay Comparison in a Large Network**

### 4.3.2.1 End-to-End Delay

Fig.4-8 shows that the end-to-end delay is about the same for FC-AOMDV and AODV in a larger network. Although not shown here, our time average measurement suggests that FC-AOMDV has a slight improvement. This can be attributed to the fact that FC-AOMDV has to spend much overhead (and therefore computing time and delay) to determine the best set of routing paths in a larger network since the table size is much bigger and the calculation is more complicated (the flow cost used in our algorithm is not only including the delay, but also taking the power and hop count into consideration). On the other hand, AODV can identify the best path with shortest delay directly. Therefore, FC-AOMDV does not seem to improve the end-to-end delay obviously over AODV.



**Fig.4-9: Throughput Comparison in Large Network**

### 4.3.2.2 Throughput

As shown in Fig.4-9, in a larger network, the improvement is more obvious, about 60000 bits/sec. This is because in a large network, there are much more nodes in the moving area which means more available routing paths. The selected path used for transmission usually includes more nodes (higher hop count) that can lead to more frequent link breakages. In addition, the larger moving area also can contribute to the more link failures. Since the AODV has no alternate path, so it cannot be as reliable as our FC-AOMDV during the transmission.

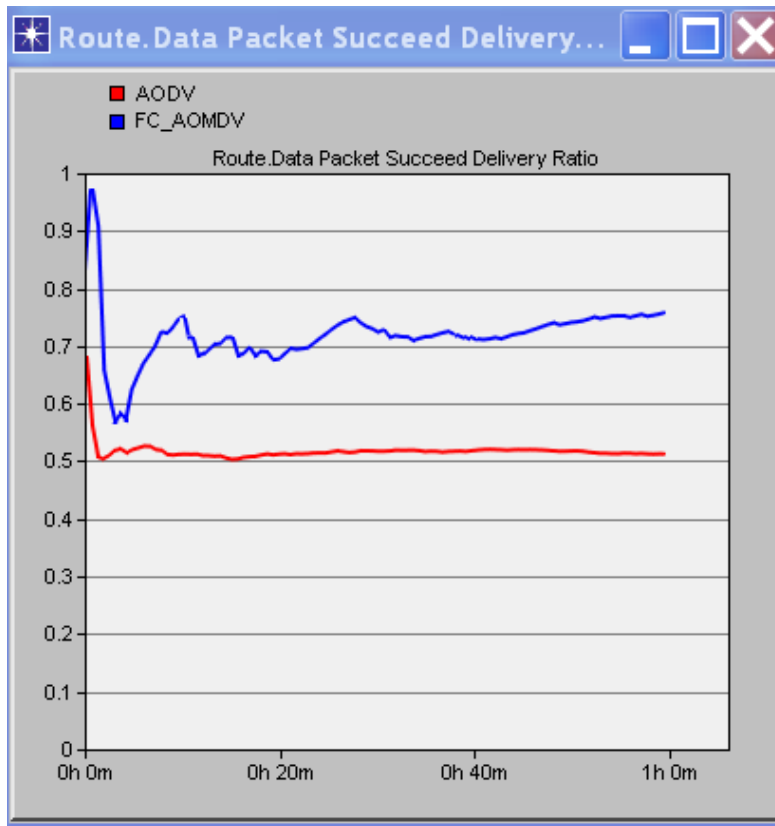


Fig.4-10: Packet Delivery Ratio Comparison in Large Network

### 4.3.2.3 Packet Delivery Ratio

Fig. 4-10 shows that Packet Delivery Ratio is about 51% in AODV. This can be attributed to many reasons such as longer routing path, congestion and node failures. On the other hand, the

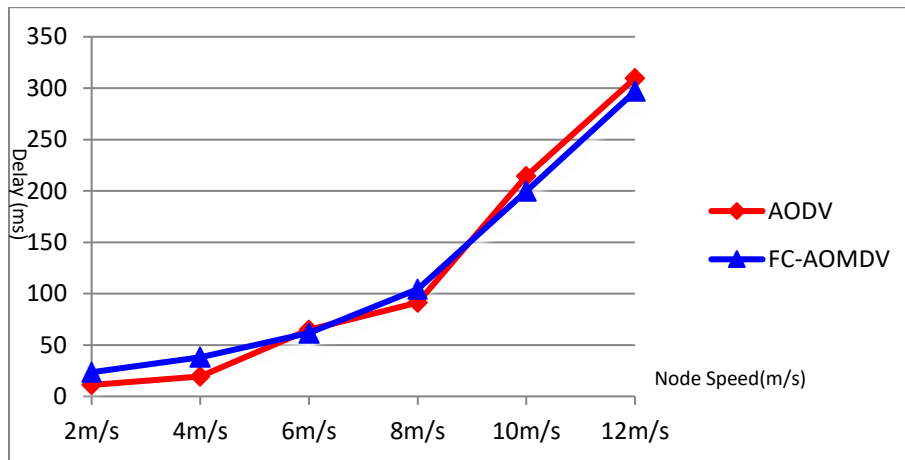
FC-AOMDV is able to keep it much higher at 75%. An increase of 24% is an very obvious improvement that shows our algorithm performs much better in larger networks. The main possible reason is that in the large network, the node and link failures are much more frequent due to the larger moving area and more intermediate nodes needed in the routing path. Our multipath routing algorithm can be more tolerant for these failures while the AODV can just retransmit the packets once the failure occurs.

From the results in the small network and larger network in Section 4.3.1 and 4.3.2, we can see that the performance is a bit worse in the large network. For example, the delay is bigger than the small network. This is because the moving area is much bigger, as a result, the distance between the source node and destination node can be much longer. This also means a longer routing path with more intermediate nodes. Since all the nodes can move randomly in this area, thus the probability of link failure increased very much. This is also the reason why the throughput and packet delivery ratio is also not as good as in small network.

#### **4.4 Video Application and Its Performance Evaluation**

With the development of MANETs, its multimedia applications have gained more and more attention. In this section, we will use OPNET simulation to test our algorithm on some video transmission applications, and demonstrate the improvements in performance. The video application can be invoked through an existing OPNET model named "Application" which allows us to directly set the related parameters of video transmission. In the beginning of our simulation, there are 20 nodes placed randomly in a 500m\*500m area. All nodes move according to the RWM(Random Waypoint Model). In this video application model, JSVM (Joint Scalable Video Model) is used to encode the video sequence into CIF(Common Intermediate Format)

with an image dimension of 352\*288 pixels and 10 fps (frames per second). Each frame is encapsulated into an UDP(User Datagram Protocol) data packet of 1024 bytes.

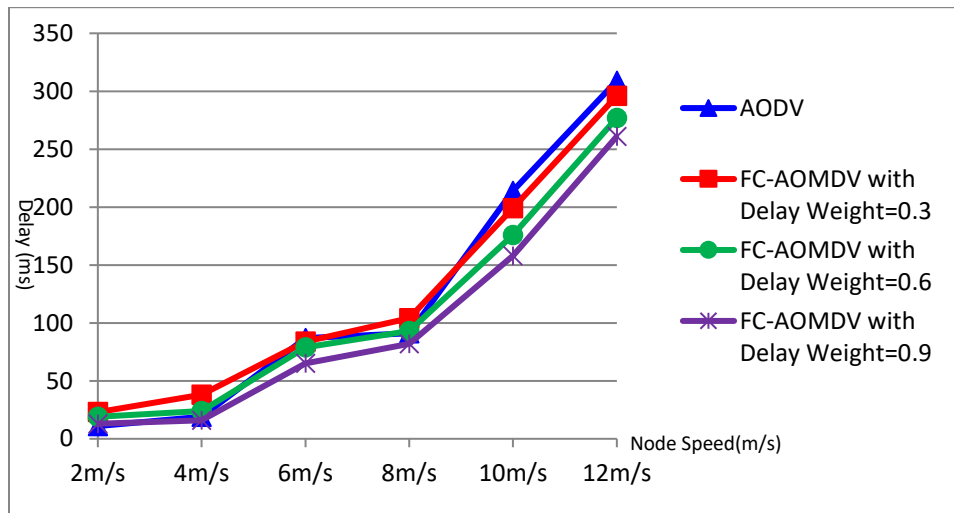


**Fig.4-11: Comparison of End-to-End Delay with Different Moving Speed**

Fig.4-11 shows that the average end-to-end delay is as an increasing function of moving speed for both protocols. Usually, lower delay means better performance in video communication. Therefore, the figure shows that AODV has a slightly better performance than FC-AOMDV when node speed is less than 9m/s while FC-AOMDV is better when above 9m/s. This is because links do not break easily in lower speeds and the AODV need not find another path often, and therefore single/shortest path routing usually can achieve a much lower delay. On the contrary, when the speeds become higher, the probability of routing path failure due to a link breakage will become larger. Route discovery has to be incurred leading to higher delay in single path routing like AODV. With FC-AOMDV, the overhead (flooding network with different types of packets during Route Discovery) from the routing discovery process will be less than AODV due to the use of multipath routing. When a primary path fails, it will automatically choose the back-up path, and avoid a new route discovery process.

For the comparison in Fig.4-11, we use a default value of 0.3 for the weight factor of the delay in the FC formulation (while those for power and hop count are 0.4 and 0.3 respectively).

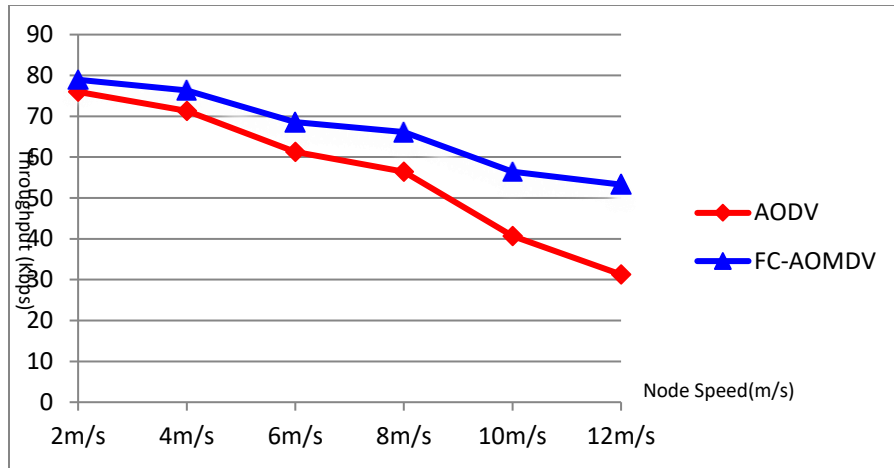
If we increase the weight of delay which means our FC value will depend on the delay much more than power and hop count, our delay performance will be different.



**Fig.4-12: End-to-End Delay Comparison with Different Delay Weight in FC**

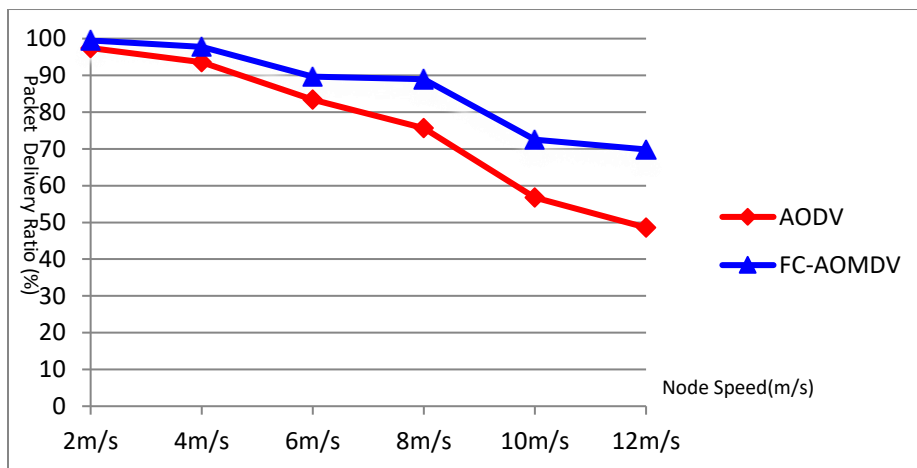
As shown in Fig.4-12, the other two delay weight values: 0.6 and 0.9 are measured. We can see the end-to-end delay is becoming smaller as we increase the value of delay weight. When Delay Weight=0.6, AODV still performs better for the moving speed smaller than 8m/s (but the difference is pretty much smaller than the weight=0.3). However, when we increased it to 0.9, our FC-AOMDV algorithm can achieve a lower delay performance after the speed > 3 m/s compared with AODV. In fact, we can also adjust the other two weight values to improve its corresponding factors' performance like power and hop count when it is necessary. Thus, we can see our proposed algorithm is more flexible since we can change the weight factors to accommodate different network requirements and achieve a better performance especially when the speed is becoming higher and higher.

Fig.4-13 shows that the average throughput is as a decreasing function of moving speed from 2m/s to 12m/s for both protocols. Obviously, higher throughput means better performance and our FC-AOMDV performs better than AODV.



**Fig.4-13: Comparison of Throughput with Different Moving Speed**

From the figure, we can see when the node speed is less than 6m/s, the difference (improvement) for FC-AOMDV is not very big. This is because when the speed is low, the link failure is less so that the advantages for multipath routing are not obvious. As the node moving speed rising, like higher than 8m/s, the improvement for our algorithm compared with AODV is becoming bigger and bigger. For example, when the speed=2m/s, our algorithm can just improve the throughput for about 3 kbps. However, when the speed=12 m/s, compared with AODV, our algorithm can improve the throughput for about 20 kbps. Therefore, we can say our algorithm is more reliable and efficient especially when the node speed is high.



**Fig.4-14: Comparison of Packet Delivery Ratio with Different Moving Speed**

Fig.4-14 presents the packet delivery ratio that can embody the reliability of a routing protocol in transferring data from the source to the destination. As shown in the figure, the percentage of correctly received packets decreases along with the increasing node moving speed. Compared with FC-AOMDV, AODV has obviously lower performance especially in high speed mobility scenarios. The possible reason is that AODV uses single routing path to forward video packets which might easily be lost or delayed due to the more frequent routing path failure with higher and higher node moving speed. On the contrary, for the FC-AOMDV, when the first path is failed, the second alternate path can instantly be used for continuing the transmission, so that to improve the transmission reliability. As a result, to increase the total successfully received packets. Although we expect a smooth performance curve, randomness in the network can attribute to small kinks here and there such as the kink at the speed of 8 m/s shown in the figure. However, it does not affect our analysis and conclusions from the comparison results.

#### **4.5 Concluding Remarks**

In this chapter, we have proposed an algorithm named FC-AOMDV which can be used in the dynamic MANET. We evaluated its performance including the end-to-end delay, throughput and packet delivery ratio in both small network and larger network. The simulation results proved that our algorithm performs better in both the small network and the larger network especially when node moving speed is high. We also applied our algorithm into the video transmission in the OPNET and compared the simulation results with the traditional routing protocol AODV. The comparisons demonstrate the improvements of our FC-AOMDV. When the node moving speed increasing, our multipath routing algorithm can use the alternate path for transmission once the route failure occurs so that to make the transmission more reliable. Compared with

AODV, our algorithm can achieve a smaller end-to-end delay, higher throughput and higher packet delivery ratio. As a result, we can say our algorithm is more efficient and reliable in a larger and higher dynamic network.

## Chapter 5

# Predictive Real-Time FC-AOMDV Routing Algorithm

This chapter focuses on improving the performance of the FC-AOMDV algorithm studied in Chapter 4. The idea of improvement comes from our observation/experience that the route discovery process after a link breakage contributes much overhead to network operation. Therefore route discovery due to frequent link breakages can impart on network performance such as delay and throughput. Hence being able to discover new alternate routes before all route possibilities are exhausted in the routing table should cut down the overhead and therefore improve the network performance. So we propose a predictive real-time approach called RPET-FC-AOMDV that can initiate a new route discovery before a route failure is about to occur rather than waiting for the link breakage to happen. We first explained how RPET (Routing Path Expiration Time) is used in the prediction. Then we analyze the effect of node speed and node density to the RPET. Based on the simulation results, we obtain the empirical formula for RPET. Finally, we compare the updated routing algorithm based on RPET with the FC-AOMDV algorithm to illustrate the performance improvements.

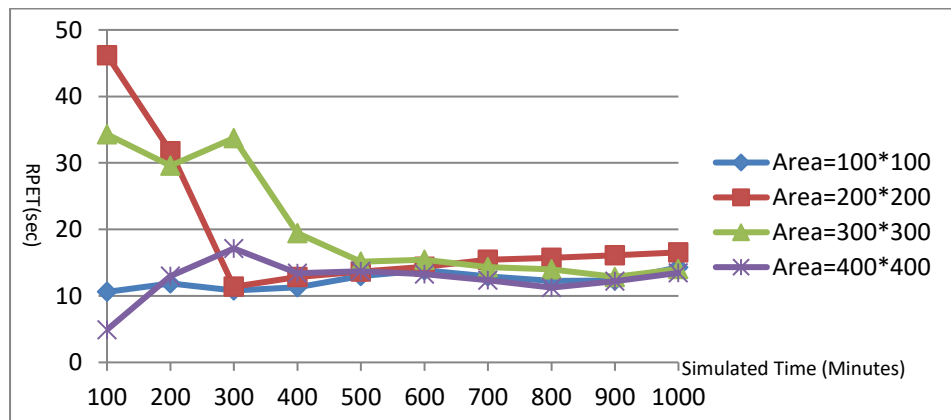
### 5.1 Design Principle

Due to the node movement, the available routing paths used among the nodes for transmitting data packets are not stable. The paths from a source node to a destination node can be disrupted depending on a few factors such as the node moving speed. Therefore, what was established originally in the routing table for the best  $N$  paths can no longer be valid after  $X$  seconds (say on the average), by which time it would be advisable to reinitiate the routing discovery process to form a new routing table .

The basic design principle is to allow a source node to predict the X value real-time to initiate a new routing discovery in order to react traffic changes faster. Here we achieve this by simple computation of an empirical formula on RPET which is the average routing path update interval to estimate the time whether a routing path is about to fail. In order to realize the real-time multipath routing, we need to get the average routing path update interval called RPET that can estimate whether a routing path is about to fail. The next section will describe our simulation work to establish an empirical formula based on statistics to predict the PRET in terms of node density and node speed before one should rerun the routing discovery.

## 5.2 Empirical Design of RPET-FC-AOMDV

In this chapter, most of the simulations are based on the following four moving areas: 100m\*100m, 200m\*200m, 300m\*300m and 400m\*400m. Since different simulated time in OPNET can lead to different simulation results, obviously, the longer simulated time, the more accurate result it is; thus it is necessary to first get the converged simulated time so that we can get a comparatively accurate result for our research. We keep the node speed and node density the same for the above four different areas and investigate different simulated time.

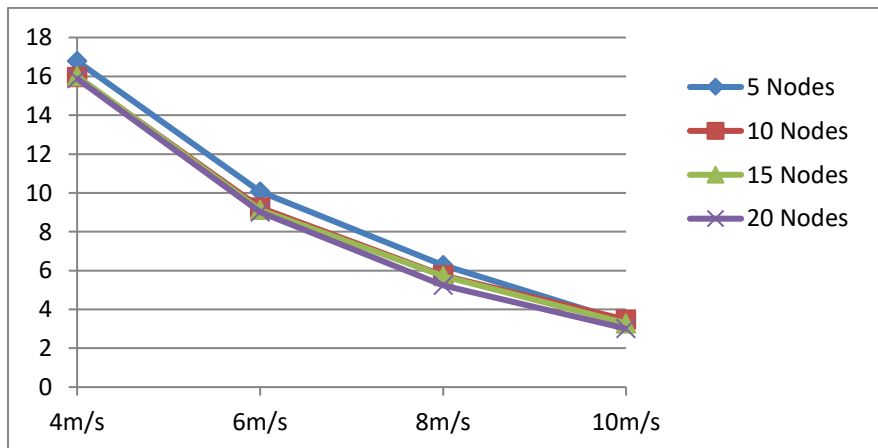


**Fig.5-1: Converge Simulated Time**

From Fig.5-1, we can see the simulation results will approximately converge after 500 minutes for all the 4 areas. Take the area of 400m\*400m for example; the RPET (purple line) stabilizes around the value of 14 seconds beyond 500 minutes of simulated time. Similar observations can be made for the convergence of the RPET for the other three areas. Thus, if we run our simulation shorter than 500 minutes, there will be a big difference and the results are not accurate. Based on this observation, we shall arbitrarily choose at least 1000 minutes as simulated time in our further investigations below.

### 5.2.1 RPET as a Function of Node Speeds

In general, the RPET is going to become smaller and smaller with the increasing of the node moving speed because link breakages will become more frequent at higher speeds. Thus, in order to get a more accurate result, we run the simulation for each speed three times with different seeds to get the mean values. We shall consider 10 nodes randomly distributed in an area of 200m\*200m. The moving speed of every node is the same and ranges from 4m/s to 10m/s.



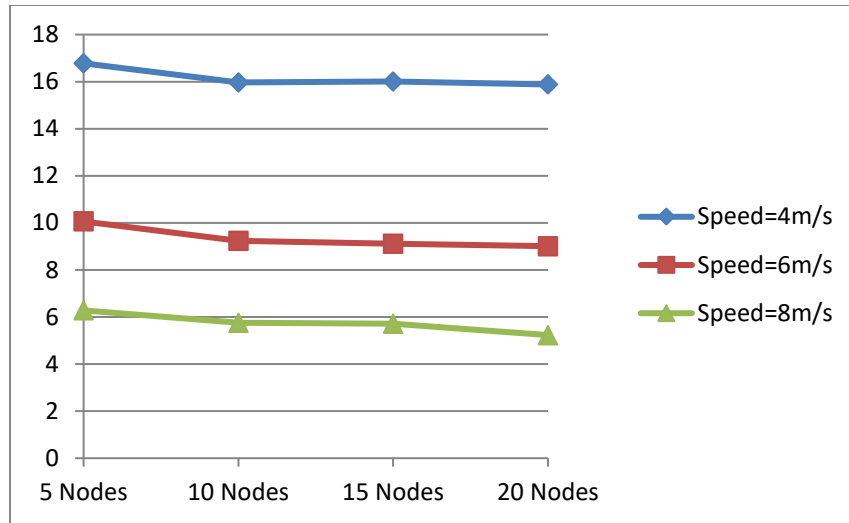
**Fig.5-2: Mean Value for RPET vs Node Speed and Node Density**

The mean value curve for RPET based on different node moving speeds is shown in the red curve of Fig.5-2. We can see the bigger moving speed, the smaller expiration time for the routing paths. For example, when the speed increases from 4 m/s to 10 m/s, the RPET decreases about 12 seconds. Obviously, the moving speed plays an important role during the routing path change/breakage.

### **5.2.2 RPET as a function of Node Density**

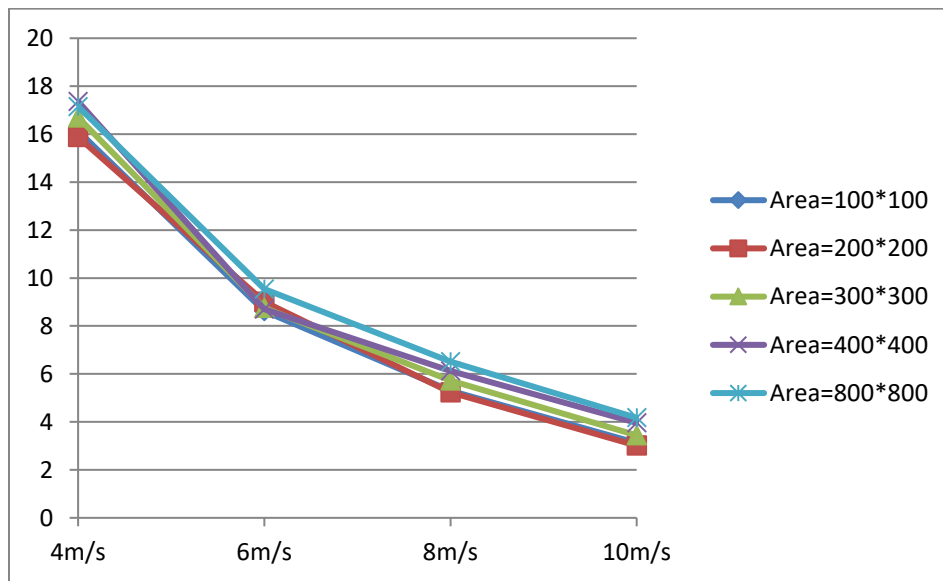
Besides the node speed, we also want to know if the node density would affect the value of RPET. In order to study this, we shall consider different number of nodes (5, 10, 15 and 20) randomly distributed in an area of 200m\*200m. The moving speed of every node is the same and ranges from 4m/s to 10m/s. Then we can get the performance curves as below.

From the results shown in Fig.5-2, one sees that node density can affect the RPET values. However, for a given moving speed, a different node density only has a very small influence on RPET. Take the node speed=8 m/s for example, the RPET difference for the four different node densities is less than one second. In fact, the higher node moving speed, the smaller difference is. This is probably due to the fact the link breakage does not just depends on the number of nodes in the moving area. Once the routing path is set up, no matter how many other nodes surrounded the selected routing path, the transmission will not be affected. The number of nodes in this area, in other words, the node density can only affect the routing path selection during the routing path discovery process. The higher node density can lead to more available routing paths. For example, 5 nodes may just have one or two available paths to the destination. However, 20 nodes may have 5 or more available routing paths. Once we make our decision about the path selection, the other nodes will not affect the current routing path until it breaks.



**Fig. 5-3: Mean Value of RPET for Different Node Density**

In order to see the influence more obvious, we are going to do a comparison for the difference of node density with 3 speeds: 4m/s, 6m/s and 8m/s. Their curves in Fig.5-3 are more or less level which means the influence for the node density is pretty small and can be ignored.



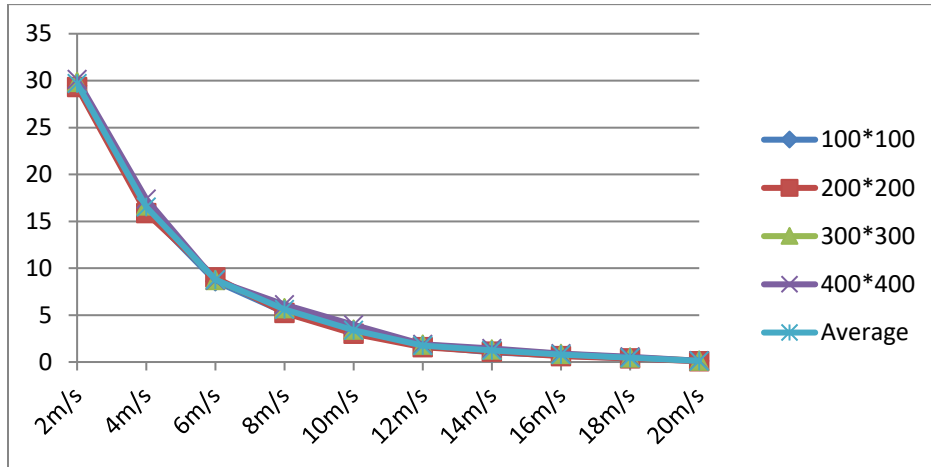
**Fig.5-4: Different Areas with Same Number of Nodes**

We want to do a further in-depth study to prove the previous conclusion. by another group of simulations. We are going to choose different areas with the same number of nodes. We

use 5 different areas: 100m\*100m, 200m\*200m, 300m\*300m, 400m\*400m and 800m\*800m which have the same number of nodes (20 nodes).The simulation results are shown in Fig.5-4. Obviously, the difference is still very small. As a result, we can conclude that the node density does not play an essential role in determining of RPET and thus we can ignore it in our formulation.

### 5.2.3 RPET Formulation

Based on the study and results in Sections 5.2.1 and 5.2.2, we know that we just need to consider the node moving speed in RPET equation. However, if we want to derive the formulation, the above results with just 4 different moving speeds are not enough. Thus, we will do a group of simulations for the speed from 2m/s to 20m/s with 4 different areas:100m\*100m, 200m\*200m, 300m\*300m, 400m\*400m. Then we can formulate the RPET based on the obtained results.



**Fig.5-5: Results with More Speeds used for Formulation**

As shown in Fig.5-5, we assume the node speed is  $S(t)$ , then we can derive the equation of routing path expiration time as below:

$$RPET(t) = \begin{cases} 54 * e^{-0.32S(t)} + 1, & S(t) \leq 12 \\ -0.19 S(t) + 3.9, & S(t) > 12 \end{cases} \quad (5-1)$$

Next we can apply the above formula into our OPNET and initiate the routing path discovery process based on eqn. (5-1) to realize the predictive real-time routing and improve the performances. The value of RPET can be obtained easily (in real-time) based on the above equation whenever there is a change for the node moving speed.

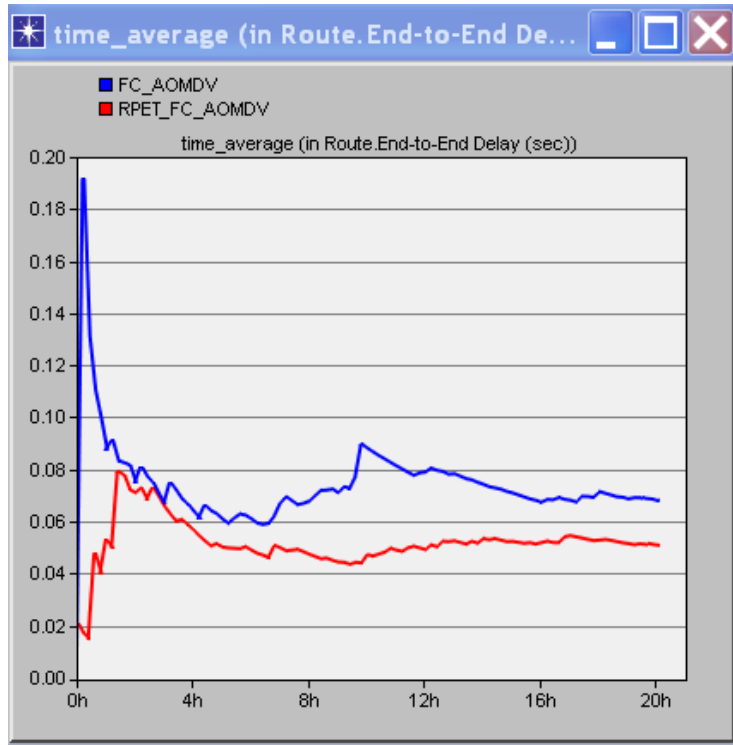
**Table 5-1: Simulation Parameters**

Parameters	Value
Moving Area	500m*500m
Number of Nodes	20
Antenna Type	Omni-directional
Packet Arrival Rate	100 packets/sec
Packet Size	128 bytes
Simulation Seed	431
Simulated Time	20 hours
Transmission in Network	Node 1 -> Node 10
Mobility Model	RWM
Node Speed	2m/s to 20 m/s

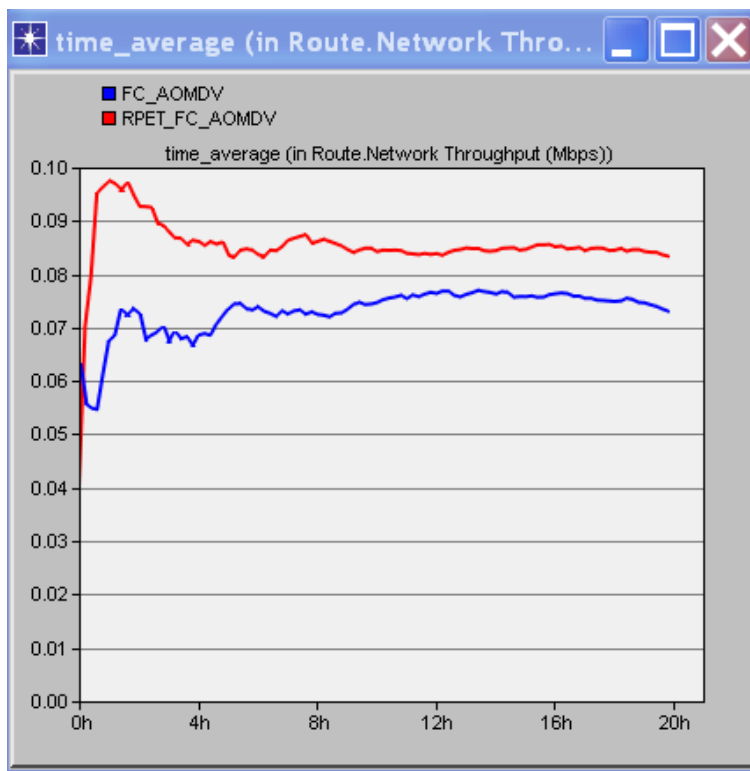
### 5.3 Performance Evaluation and Comparison

The proposed algorithm is implemented in the OPNET simulator. The performance metrics such as end-to-end delay, throughput and packet delivery ratio are taken into account. The considered simulation parameters are given in Table 5-1.

We shall evaluate the end-to-end delay, throughput and packet delivery ratio for our predictive real-time multipath routing REPT-FC-AOMDV. We are going to do a comparison with FC-AOMDV to see if the updated algorithm can improve the performance. Let us first take the speed=10m/s as an example.



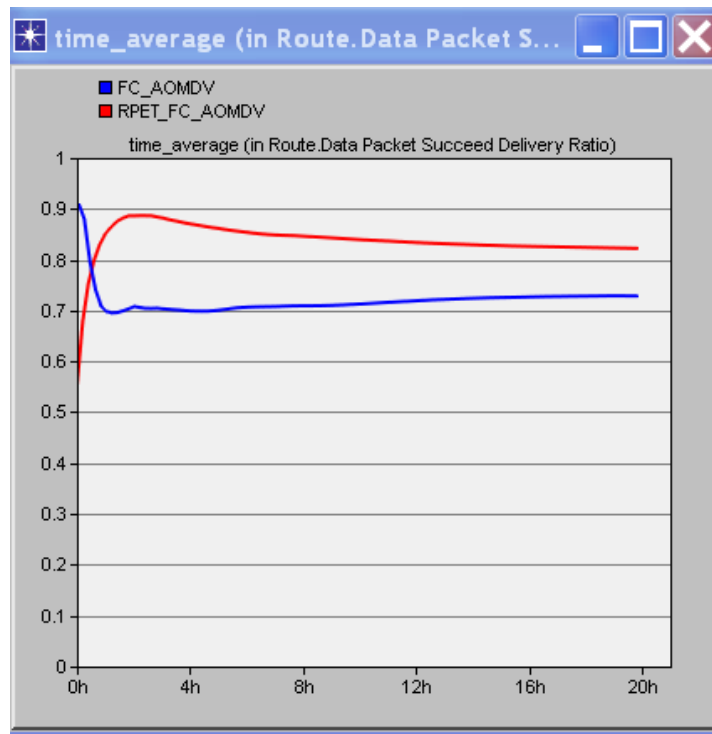
**Fig.5-6: End-to-End Delay Comparison with Speed=10m/s**



**Fig.5-7: Throughput Comparison with Speed=10m/s**

As shown in Fig.5-6, the end-to-end delay can be improved by our proposed RPET-FC-AOMDV (red line) compared with FC-AOMDV (blue line). When the moving speed=10m/s, the delay for FC-AOMDV is about 68 ms while after applied the RPET in the multipath routing, the delay can decrease to about 53 ms. The delay performance can be improved for about 15 ms. We know in the dynamic mobile ad hoc network, the routing paths are usually unavailable after a specific time. When we applied our algorithm based on RPET, we can decrease the link breakages due to the prediction of routing path expirations and as a result to achieve a lower delay.

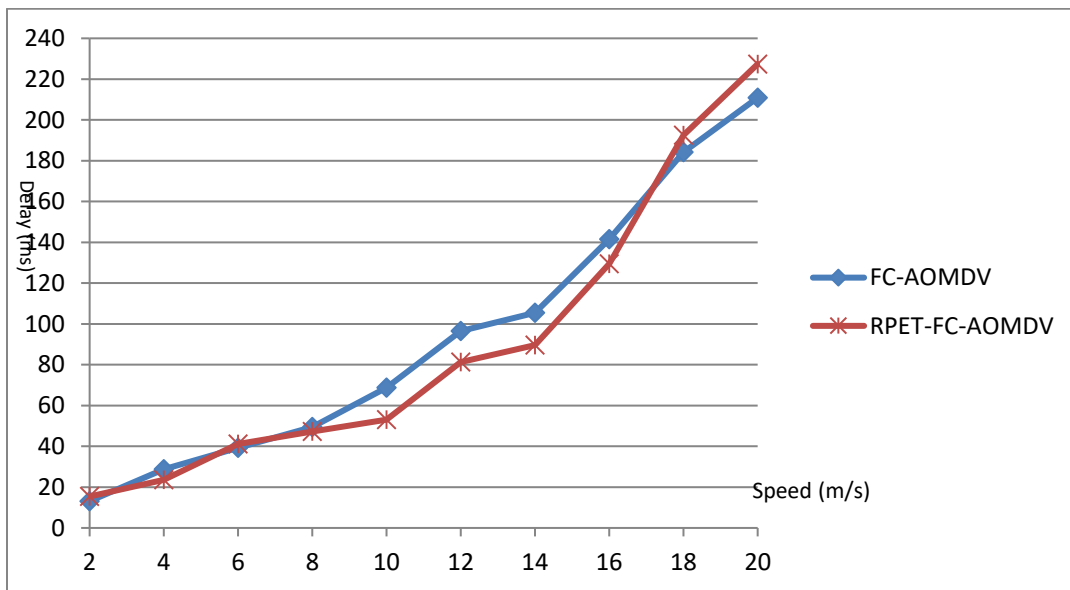
Our RPET-FC-AOMDV can improve the throughput for about 10 Kbps as shown in Fig. 5-7. This is because the routing algorithm based on the RPET can predict the routing path failure before it is about to break instead to wait for the breakage. Thus our algorithm can make the transmission more stable.



**Fig.5-8: Packet Delivery Ratio Comparison with Speed=10m/s**

Similarly with the throughput, the RPET-FC-AOMDV can also improve the packet delivery ratio. As shown in Fig.5-8, it can improve about 9% for the successful delivered packets from source to the destination which can demonstrate the efficiency of our proposed algorithm.

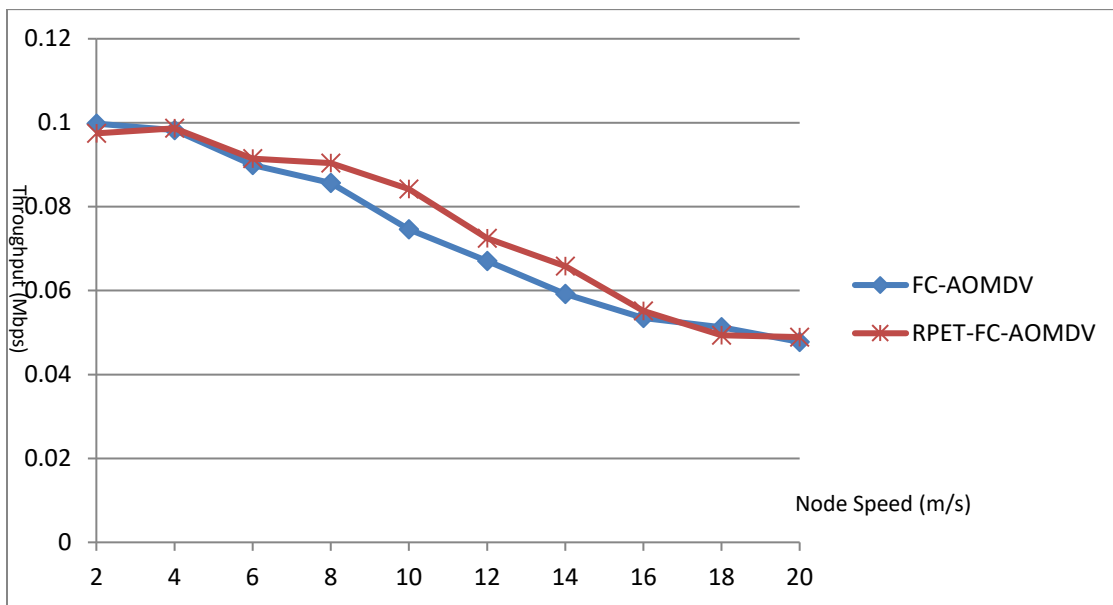
After the successful performance at 10 m/s as seen in Fig.5-6 to Fig.5-8, we like to explore its capability in other operating ranges. Below we shall show another case of 20 nodes moving randomly distributed in an area of 500m\*500m. There is only one transmission in this network from Node 1 to Node 10 of which the performance we shall study as the node moving speed ranges from 2 m/s to 20 m/s.



**Fig.5-9: Comparison for End-to-End Delay with Different Speeds**

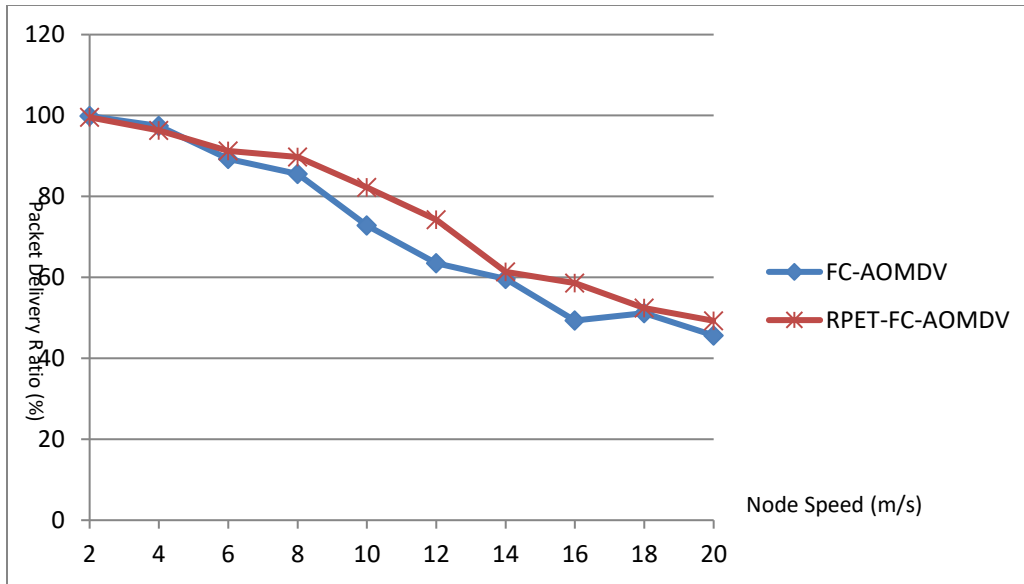
Fig.5-9 demonstrates that the average end-to-end delay has a tendency to increase with the higher node moving speed for both two multipath routing protocols. According to the result curves, when the node speed is smaller than 8 m/s, the difference is pretty small and the performance for the two protocols is similar. When the moving speed increases, like from 8m/s to 17 m/s, the routing protocol based on RPET can decrease the end-to-end delay. However, when the moving speed become much higher, like 18 m/s and 20 m/s, FC-AOMDV becomes

better again. Therefore, we can conclude that our predictive real-time routing algorithm based on RPET is mainly effective between the speeds of 8m/s to 17 m/s. The possible reason may be that when the speed is low, the link breakage is much less so that the advantages for our algorithm based on RPET is not obvious, while when the speed becomes higher (e.g., > 18 m/s), the routing expiration time is too small so that the ability of our proposed algorithm to decrease the link breakage becomes much lower. In addition, when the speed is high enough, our algorithm may lead to more routing discovery so that a longer delay may result.



**Fig.5-10: Comparison for Throughput with Different Speeds**

From Fig.5-10, we can see the throughput decreases with the increasing of node speed. However, when the node moving speed is lower than 6 m/s or higher than 16 m/s, the throughput is similar for the two routing protocols. For the speed between 6 m/s and 16 m/s, our algorithm can effectively improve the throughput. Take the speed=10 m/s for example; our predictive real-time routing can improve the throughput for about 10000 bps. Thus, we can say our RPET-FC-AOMDV is mainly effective to improve the throughput for the speed from 6 m/s to 16 m/s.



**Fig.5-11: Comparison for Packet Delivery Ratio with Different Speeds**

From Fig.5-11 we can see the packet delivery ratio is significantly reduced when the node speed increases. When the speed is lower than 6 m/s or higher than 18 m/s, the improvement is not obvious which is similar with the throughput. However, for the speed between 6 m/s and 18 m/s, the RPET-FC-AOMDV obviously performs better. For example, when the speed=10 m/s, our proposed protocol can improve the packet delivery ratio for about 10%.

#### 5.4 Concluding Remarks

In this chapter, we studied the influence of node moving speed and node density to the routing path changing frequency. Based on a number of simulation results done in OPNET 14.5, we have derived an empirical equation for RPET (Routing Path Expiration Time) that we applied to the same study of our FC-AOMDV algorithm in Chapter 4 to realize the predictive real-time multipath routing which avoids the wait until the last minute when all good paths are exhausted. The RPET-FC-AOMDV proposed in this chapter is an extension of FC-AOMDV. The

simulation results and comparisons show that our algorithm can effectively improve the network's end-to-end delay, throughput and packet delivery ratio for medium moving speeds in a dynamic network topology.

## Chapter 6

### Routing Protocol in 3D MANETs

The previous three chapters are all based on 2D MANETs. We shall now expand the scope to a 3D MANET. We shall use the greedy routing for 3D network transmission and explore the problems that come with it. Then we extend the greedy routing algorithm to overcome these problems in order to improve the performance. Finally, we conduct some OPNET simulations to demonstrate the improvement by comparisons with different node speed and node density.

#### 6.1 Design Consideration for 3D Routing

We have summarized the differences between 2D and 3D network in Section 1.2.3.3.3. The networks like the AANET are usually much more dynamic and the nodes move very fast. Thus, the topology has a limited lifetime and needs frequent routing path updating.

One of the most important points we need to consider when design the 3D network routing is the more complicated localization. 2D protocols cannot be directly applied to 3D network environment since it does not see the extra dimension. Using Euclidean measurement mathematically, the distance between two nodes in a 2D plane  $\{X,Y\}$  is calculated by  $dist(u, v) = \sqrt{(u_x - v_x)^2 + (u_y - v_y)^2}$ , while that for 3D  $\{X,Y,Z\}$  is calculated by  $dist(u, v) = \sqrt{(u_x - v_x)^2 + (u_y - v_y)^2 + (u_z - v_z)^2}$ . All 2D nodes are assumed to be at the same depth and equal distance trajectory is a circle where in 3D network equal distance occurs on the surface of a sphere to account for an arbitrary depth.

Take for example the greedy routing between two 3D nodes A(1,2,1) and B(6,6,8). Suppose each node has a communication range of 8 units. In 3D routing, their actual Euclidean

distance is  $\sqrt{90}$ , and hence node A knows that node B is not available for direct communication and will require an intermediate node to relay its transmission. Since the 3<sup>rd</sup> coordinate is ignored in 2D routing algorithm, node A will see a distance of  $\sqrt{41}$  (less than 8) only to node B and attempt to send to node B, which we know will not be transmitted successfully in the actual 3D network.

Another example is the confusion to the source node when only the first two coordinates are considered when running a 2D algorithm in a 3D network. Assume node A(3,3,2) is trying to send to node B(7,7,4) when node C(7,7,6) and D(7,7,9) also exist. Then node A will not know which one to send as they all have same coordinates of (7,7) in 2D network.

Based on the summary above, we will attempt to explore some basic study for the 3D MANET in this chapter.

## **6.2 3D Routing Protocol**

The routing protocols studied in previous chapters are topology-based routing as discussed in Section 1.5. As seen there, excessive overhead may be required to update network topology information in a mobile environment. In large and highly dynamic networks, high overhead and large routing table size are obvious for 2D networks and become even more so in 3D networks due to the extra dimension in routing. For example, the flooding mechanism used in AODV to propagate the RREQ messages in the entire network will become unsustainable. Therefore, the topology-based routing protocols used in previous chapters are not appropriate for highly dynamic 3D MANET.

This brings us to position-based routing which can potentially eliminate some of the limitations of the topology-based protocols. Position-based routing protocols use the geographic position information to make routing decision. They are local because a node forwards the

message-based only on the position of the destination and the position of its neighbors to which it can communicate directly. A node does not require a global knowledge of the network, but rely on the geographical information only such as its coordinate; this can be acquired either by using a location service such as GPS (Global Positioning System) or other types of position services. Neighbor discovery is an essential mechanism in the 3D routing protocol.

### **6.2.1 Neighbor Discovery**

In general, we can assume each node can acquire its position (longitude, latitude and altitude) information from the GPS. Each node would periodically broadcast a small packet called the "beacon" that contains its identity, position and other information (e.g. its speed and direction) to all its immediate neighbors. Such beaconing process would allow a node to eventually collect and store location information of all its neighbors in a table. This proactive approach is totally independent of the data traffic.

### **6.2.2 Greedy Routing**

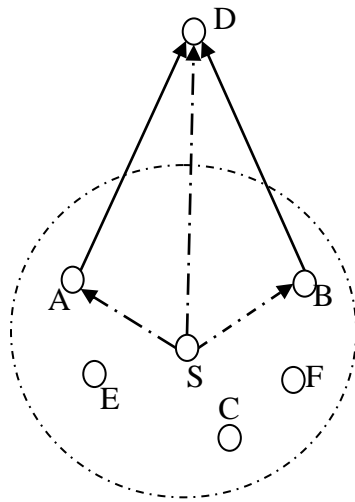
Greedy routing is one of the most popular geographical routing protocols. With greedy forwarding strategy, the current node usually forwards the packet to the neighbor node nearest to the destination that minimizes the distance. Assuming source node S needs to send a packet to destination node D (assume the coordinates of D can be obtained by S via GPS and then it's easy for S to calculate the distance for its neighbors to the destination), where S and D are not in the direct transmission range of each other. Node S will pick an intermediate node I from its neighbor table obtained by the beaconing process in Section 6.2.1 such that node I is closer to node D than node S. Node I will follow the same procedure until a penultimate node which had



As shown in Fig.6-1, suppose source node S wants to communicate with destination node D outside its transmission range. Since nodes A and B are within its transmission range, node S will choose either node that has shortest distance to D. Unfortunately, the distance from A to D or from B to D are longer than node S to D. Hence, no node can be chosen for the forwarding even though there exist two paths, SACD and SBED, that can be used for the transmission.

### 6.2.3.2 The Equal Distance Problem

In greedy routing protocol, when a node wants to select a neighbor with shortest distance to the destination as its next hop forwarding, it is possible to exist more than one nodes that has the same shortest distance to the destination. Which one should be chosen as the next forwarding node becomes a problem. To our best knowledge, there is no paper proposes this problem yet. Thus, we give it a name called EDP (Equal Distance Problem).



**Fig.6-2: Equal Distance Problem**

We are going to illustrate the EDP through an example shown in Fig.6-2. Suppose source node S wants to transmit packets to destination node D out of its transmission range. The

neighbor table of S includes 5 nodes: A, B, C, E, F. The distance to destination from node C, E and F are longer than node A and B, thus next hop will not be chosen from these three nodes. Nodes A and B have the same shortest distance to D. According to greedy routing, source node S needs to select a node that has the shortest distance to the destination. However, both the node A and B has the equal shortest distance, we can say node A and B are the equal candidate, so which one should be chosen becomes a problem.

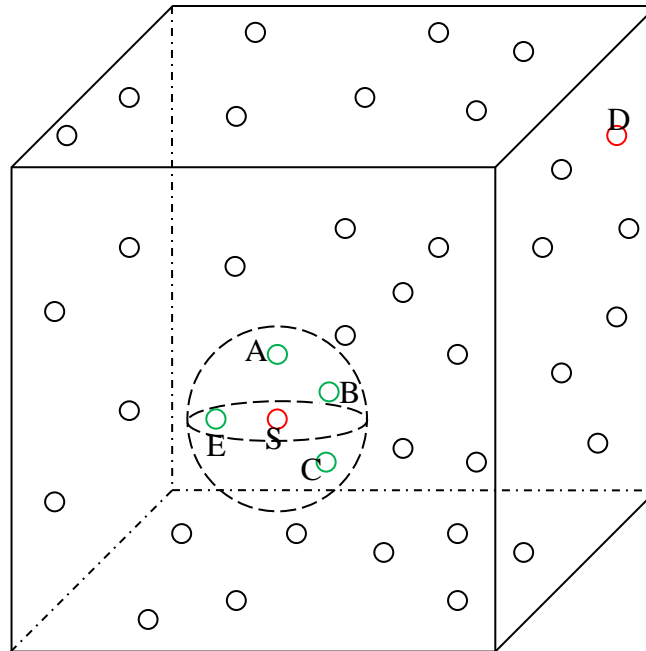
#### 6.2.4 3D Greedy Routing Design Based on Flow Cost

In order to solve the two problems proposed in Section 6.2.3, we propose an algorithm called the FC-3DGR (3D Greedy Routing based on Flow Cost) by not only taking into account the shortest distance, but also the number of neighbors. Consider  $n$  nodes moving in a cube space with dimension  $(x_{max}, y_{max}, z_{max})$ . Suppose a source node  $u$  wants to transmit data to the destination node  $d (x_d, y_d, z_d)$ . As done in the algorithms of previous chapters, we shall formulate the following FC in order to select a forwarding node  $v(x_v, y_v, z_v)$  in the next hop from among all its neighbors.

$$FC_{3D} = \frac{dist(v,d)}{dist_{max}} + \frac{n-n_{neigh}}{n} = \frac{\sqrt{(d_x-v_x)^2+(d_y-v_y)^2+(d_z-v_z)^2}}{\sqrt{x_{max}^2+y_{max}^2+z_{max}^2}} + \frac{n-n_{neigh}}{n} \quad (6-1)$$

where  $n_{neigh}$  is the number of neighbors obtained from the neighbor table of  $v$ . The first component is about the shortest distance to destination and the second component measures the number of neighbors. Since the distance and number of neighbors take on different units and different magnitude, thus we normalized each parameter with the maximum distance and total number of nodes respectively so that their contributions become values between 0 and 1. A smaller Flow Cost means a shorter distance to destination and larger neighbor table size. Shorter

distance means faster transmission and larger neighbor table size means more good choices for routing paths. Therefore, our proposed FC-3DGR will choose the next forwarding nodes with smallest  $FC_{3D}$  value until reaching a node with the destination in its neighbor table. The probability for existing two or more equal candidate nodes become much smaller when we use  $FC_{3D}$  than just use the distance. But if there are two nodes have the same FC, we will choose the first one.



**Fig.6-3: Example for FC-3DGR**

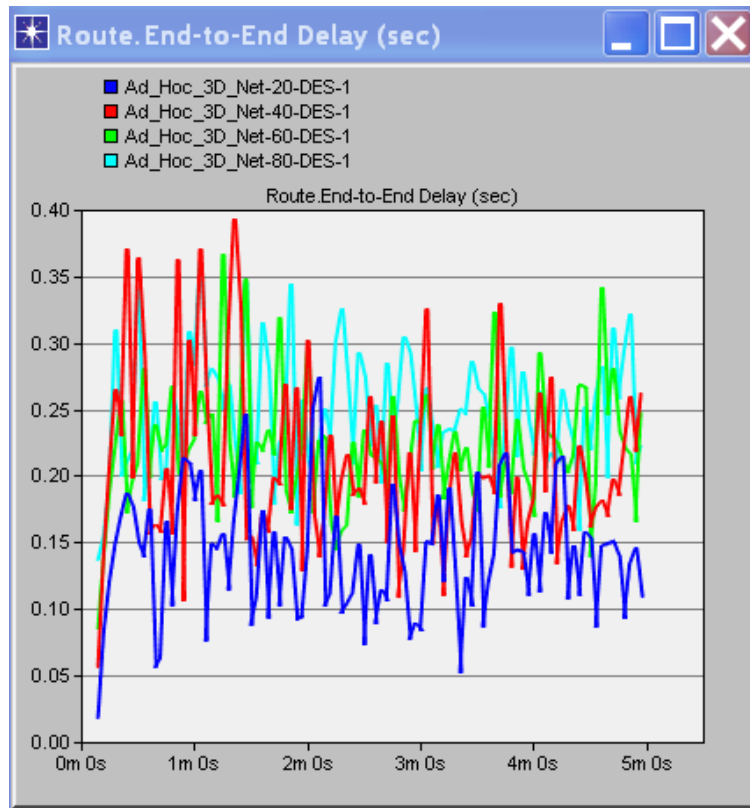
#### 6.2.4.1 Example

Fig.6-3 is an example of 40 nodes moving in a cubic space of 100x100x100. The source node S(40,50,20) wants to transmit data to the destination node D(100,90,90). It needs to first select a node as the next forwarding node from all its four neighbors A(35,60,40), B(50,60,25), C(50,45,10), E(25,50,20). The number of neighbors for neighbor node A, B, C, E is 3, 5, 4 and 2

respectively. The distances from A, B, C and E to the destination node D based on the given coordinates can be obtained which are 87, 87, 105 and 110 respectively (note that both nodes A and B have the same shortest distance). According to eqn. 6-1, the 3D Flow Costs of A, B, C and E are 1.43, 1.38, 1.51 and 1.59 respectively. Obviously, node B with the smallest Flow Cost (1.38) will be selected as the next node for forwarding the packets.

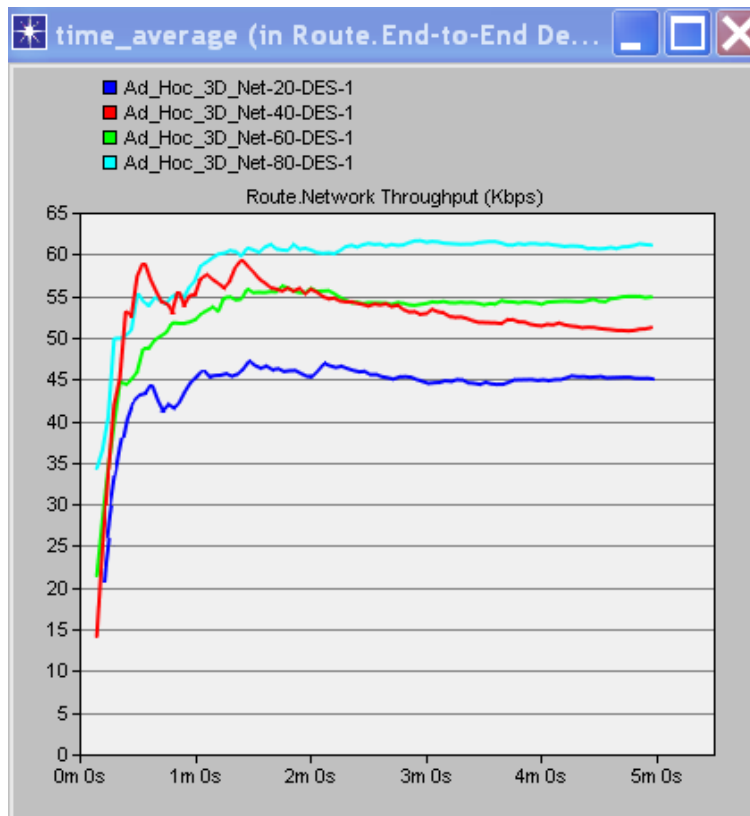
### 6.3 Performance Evaluation

We evaluate the performance of our proposed FC-3DGR algorithm in terms of end-to-end delay, throughput and packet delivery ratio. In our OPNET simulation, we create a moving space of 150km\*150km\*150km and we compare the results with different node densities and node speeds.



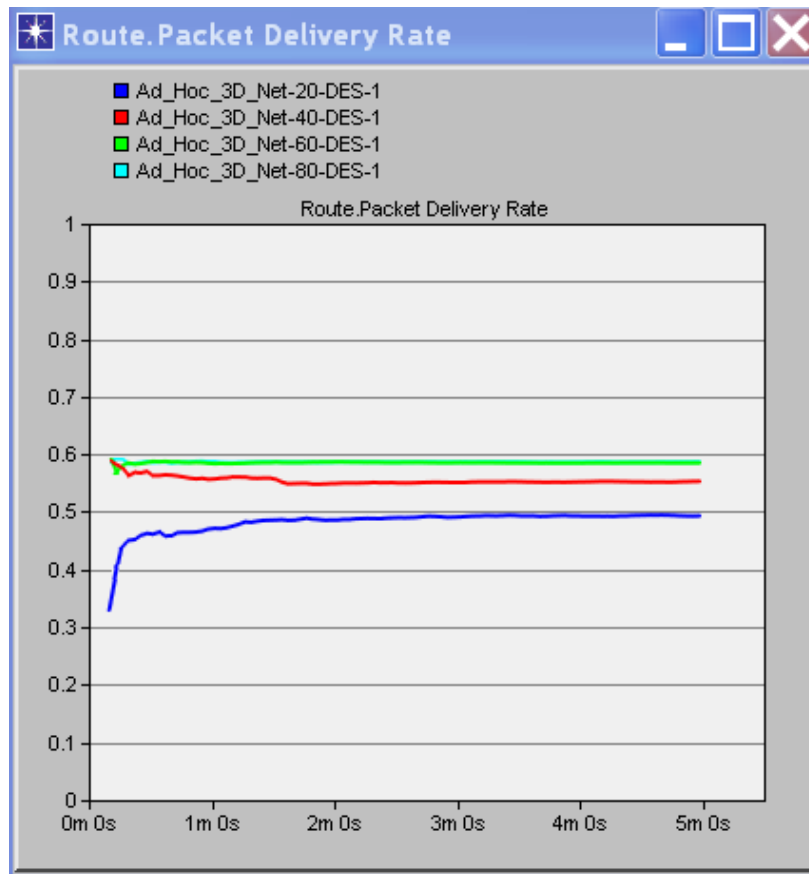
**Fig.6-4: End-to-End Delay with Different Node Density**

In order to evaluate the influence for different node density, we first study the end-to-end delay for different number of nodes (20, 40, 60 and 80) in the same moving space. Fig.6-4 shows that the end-to-end delay for the highest node density (80 nodes showed in light blue) is about 0.25 second, while for the lowest node density (20 nodes showed in dark blue) is about 0.14 second. For the medium node densities with 40 nodes and 60 nodes, the end-to-end delay is about 0.2 sec and 0.22 sec correspondingly. Generally speaking, higher node density (with more number of nodes) usually can lead to a bit higher end-to-end delay. As verified by trace files not shown here, more number of nodes means much more choices of the routing paths and sometimes the selected routing path may be a bit longer (with a bit more number of hops). As a result, the delay may be increased slightly due to the longer queueing delay, processing delay and propagation delay.



**Fig.6-5: Throughput with Different Node Density**

Fig.6-5 shows that different node densities can also affect the throughput of the network. When node density is low (e.g. when there are 20 nodes in the network), the number of available routing paths from source to destination is limited or can even be non-existent. Therefore, the throughput is only 45 Kbps. When the node density becomes higher(e.g., 80 nodes), it is much easier to find a path for the transmission so that the throughput has been improved by about 15 Kbps to 60 Kbps.

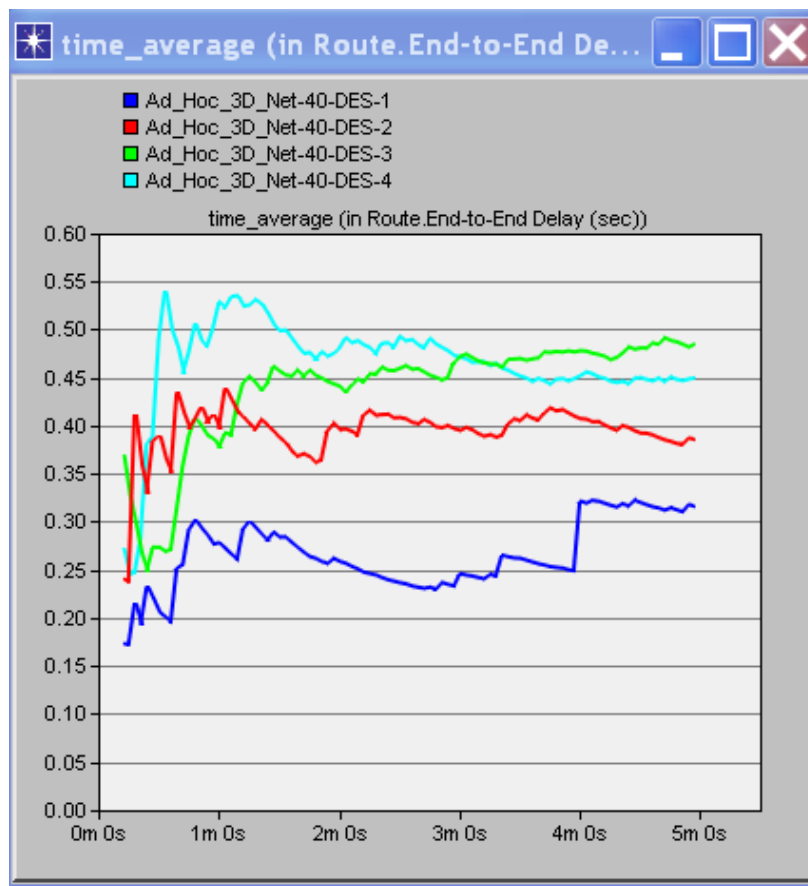


**Fig.6-6: Packet Delivery Ratio with Different Node Density**

Fig.6-6 gives the time evolution of packet delivery ratio for packet transmission in the network. Like Fig.6-5, a higher node density can increase the number of successful packets transmitted to the destination. For example, when the number of nodes=20, the packet delivery ratio is about 50%, which increases to 60% when number of nodes = 80. From the figure, we

can see the ratio is almost the same for the 60 nodes and 80 nodes. This is because when the number of nodes become more and more, the influence will become smaller and smaller since the available routing paths are already enough to be selected for the transmission.

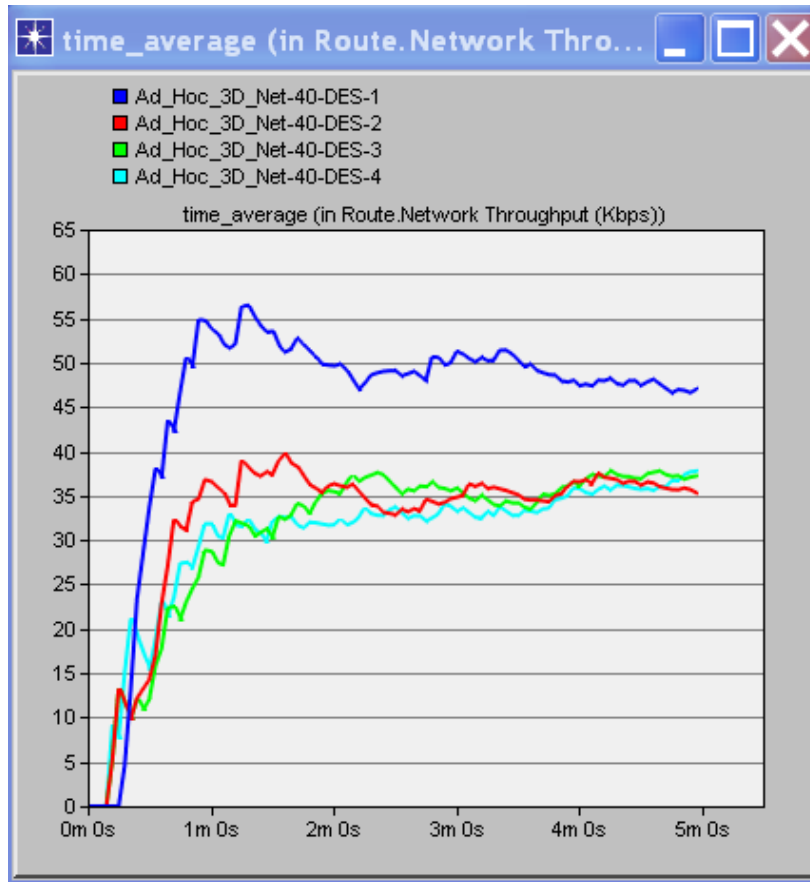
We have also investigated the influence of node speeds to the performance measures of end-to-end delay, throughput and packet delivery ratio. Below we present the investigation results of a network with 40 nodes for different node moving speeds of 50 m/s, 100 m/s, 150m/s and 200 m/s.



**Fig.6-7: End-to-End Delay with Different Node Speed**

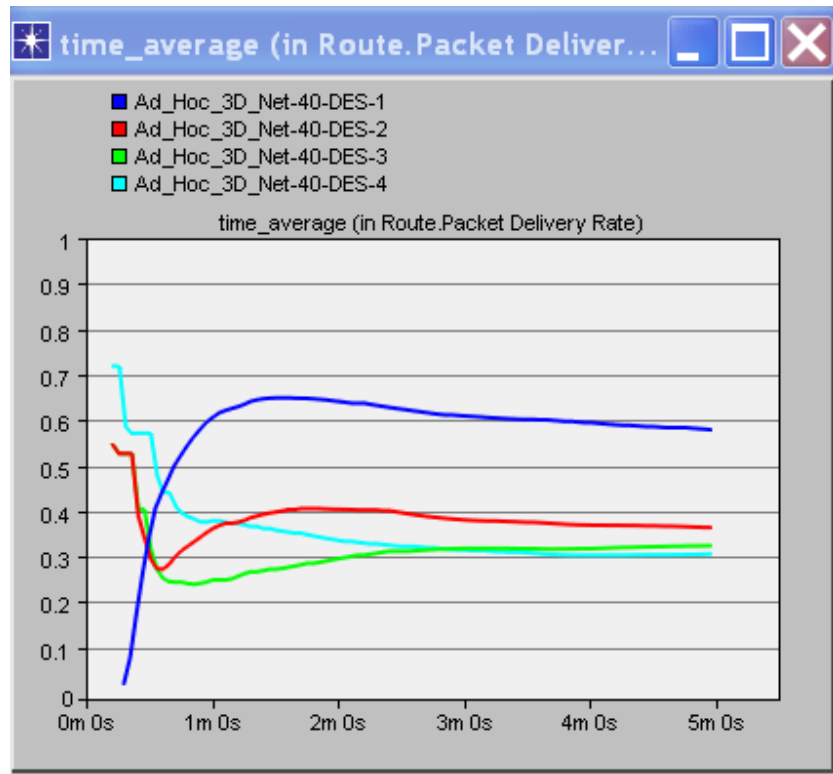
In Fig.6-7, the blue curve of DES-1 is 50 m/s, the red curve DES-2 is 100 m/s, the green curve DES-3 is 150 m/s and the light blue curve DES-4 is 200 m/s. We can see that lower speeds can achieve a relatively lower end-to-end delay. This is because a higher moving speed can lead

to much more link breakages and the source node needs to frequently search for new available routes for transmission, thus increasing the delay. For example, when the node moving speed increases from 50m/s to 150m/s, the end-to-end delay has also increased for about 200 ms.



**Fig.6-8: Throughput with Different Node Speed**

Fig.6-8 is about the throughput comparison for the four different node moving speed. Obviously, lower moving speeds can achieve higher throughput due to the less link breakages. As shown in the figure, when the moving speed increases from 50m/s to 100m/s, the throughput decreases about 10 Kbps. We can see in the steady state, the throughput for the speed of 100 m/s, 150 m/s and 200 m/s is similar which may due to the reason that when the speed is fast enough, the difference of link breakages will become much smaller.



**Fig.6-9: Packet Delivery Ratio with Different Node Speed**

Similar to the throughput, the packet delivery ratio also drops with respect to increasing node speed. Fig.6-9 shows that the packet delivery ratio for node speed of 150 m/s and 200m/s is only about 30%. It's not much better in the steady state. The possible reason may due to the frequent routing path failures. When the moving speed is very high, the routing path can be expired very soon and lead to the packet lost and retransmission. Thus, how to improve the packet delivery ratio under the high speed in 3D MANET is a very challenge problem in the future research.

#### 6.4 Concluding Remarks

In this chapter, we have shown that 3D networks can be much more complicated through comparison with 2D networks, and then identified the couple challenges in 3D network to be explored. We have used the beaconing method for neighbor discovery in our Greedy Routing

Algorithm. As an extension, FC-3DGR algorithm has made use of Flow Cost to address the Void Node Problem and the EDP (Equal Distance Problem). Our performance evaluations via OPNET simulations show that higher node densities and lower moving speeds usually can result in a better performance. Thus, how to improve the QoS with higher moving speed in large 3D network remains a challenging problem.

## **Chapter 7**

### **Conclusions and Future Work**

In this thesis, we first proposed the routing algorithm called GANFA in static mobile ad hoc network which is globally aware of the network flows from other parts of the network. This is done through the introduction of a FC (Flow Cost) that can capture many metrics of interest, but not just the shortest distance or smallest delay as done in many traditional algorithms. In our case it is the combination of power, time delay and hop count (and later, queueing delay) that would allow us to capture the influence of flows from other parts of the network through their interaction at a given node. The FC also allows us to choose the best path through optimization and to provide bandwidth allocation. As far as we know, there is no bandwidth allocation with this interaction carefully studied so far. Based on GANFA, we improved the optimization model with consideration of utilization factor. We have used simulation to verify the performance of our proposed algorithms. The results confirm that these algorithms can improve the network throughput obviously.

We have further extended our study to the dynamic mobile ad hoc network by proposing the FC-AOMDV multipath routing algorithm which prepares a back-up alternate path at the same time that the primary route is set up so that it can be used immediately for transmission in case of the failure for the primary routing path. The OPNET simulation results show that this algorithm can improve the performance of end-to-end delay, throughput and packet delivery ratio in both small networks and big networks. A comparison of FC-AOMDV and the AODV for video application in OPNET is done to prove the performance improvement of our proposed algorithm.

With the consideration of the real-time transmission requirement, we designed a predictive real-time approach based on the RPET (Routing Path Expiration Time) which taking the node speed and node density into account and name it as RPET-FC-AOMDV. This algorithm can initiate the routing discovery when a route failure is about to occur rather than waiting for the link break to happen.

Besides applying the FC in 2D network routing, we have also use it to design the FC-3DGR for AANET application in which we have explored the 3D localization and high moving speed issues. Unlike using distance as the only criteria in greedy protocols, our FC accounts for both distance and number of neighbors for routing path selection. In this way, we can avoid some problems such as VNP encountered in other greedy routing study.

My Ph.D. thesis work over these past few years has been a challenging but valuable research experience for me. One very difficult part in my work is to implement the proposed algorithms in OPNET. A lot of time was spent on debugging the OPNET simulation programs and verifying the correctness of the operation. The incompatibility of OPNET with windows system and the license problems also took a lot of time to resolve. Another difficulty is to realize the 3D network in OPNET since there are much fewer references that can help me in the design, but I have eventually solved these problems and obtained the related results.

## **7.1 Future Work**

We hope our work can lead to more important and interesting work to come. Below is some remaining work we wish to complete plus a number of new directions for further research:

- 1) Explore an efficient bandwidth allocation optimization model based on the Flow Cost for a dynamic mobile ad hoc network with high moving speed.
- 2) Include the effect of multipath fading during the transmission.

- 3) Make the real time routing algorithm based on RPET more effective for higher speeds beyond 20 m/s.
- 4) Use directional antenna [ChVa04, GaMa07, ShZh13] to improve routing discovery efficiency in MANETs.
- 5) Apply the zone routing in 3D network to reduce the flooding area.
- 6) Explore more effective multipath routing algorithms (both position-based and topology-based) in 3D MANET based on the work in Chapter 6.
- 7) Make more comparisons for the algorithms proposed in this thesis with the other traditional protocols. This would require OPNET coding of their algorithms.
- 8) Estimate the percentage of overhead generated and analyze the complexity.
- 9) Study the effect of mutual interference from non-orthogonal wireless channels.
- 10) A general global bandwidth optimization for any set of paths possible between a pair of source and destination nodes.
- 11) Verify the performance of our algorithm with the help from industry. This can be challenging as there would be more difficulties and complication when working with real network but otherwise a very rewarding experience if realized.

## References

- [AaTy13] Aarti, and S.S.Tyagi. "Study of MANET: Characteristics, Challenges, Application and Security Attacks." *International Journal of Advanced Research in Computer Science and Software Engineering*. Vol.3 Issue 5. pp:252-257. May 2013.
- [AlBr13] Rani Al-Maharmah, Guido Bruck and Peter Jung. "Practical Methodology for Adding New MANET Routing Protocols to OPNET Modeler". *Proceedings of SIMUL*. Venice, Italy. Oct.27-Nov.1st, 2013.
- [AlDo10] Abdel Ilah Alshabtat, Liang Dong. "Low latency routing algorithm for unmanned aerial vehicles ad hoc networks. " *International Journal of Electrical and Computer Engineering*. Vol 6, No. 1. 2010.
- [AlSe16] Aymen Al-Aniand, Jochen Seitz. "QoS-aware Routing in Multi-rate Ad hoc Networks Based on Ant Colony Optimization." *Journal of Network Protocols and Algorithms*. pp:1-25, Vol. 7. 2016.
- [Aimm17] AIMMS, Version 2016, <https://www.aimms.com/>. downloaded on 2017.
- [BeFo02] SalvatoreBellofiore, Jeffrey Foutz, Ravi Govindarajula, Israfil Bahceci, Constantine A. Balanis, Andreas S. Spanias, Jeffrey Capone and Tolga Duman. "Smart antenna system analysis, integration and performance for mobile ad-hoc networks (MANETs)." *IEEE Transactions on Antennas and Propagation*, Vol 50. No.5. pp: 571-581. 2002.
- [BeGa84] D. Bertsekas, E. Gfni, and R. Gallager. "Second Derivative Algorithms for Minimum Delay Distributed Routing in Networks." *IEEE Transactions on Communications*. Vol. 32. pp:911-919. 1984.
- [BaRa13] Ankur O.Bang, and Prabhakar L. Ramteke. "MANET: History, Challenges And Applications." *International Journal of Application or Innovation in Engineering & Management (IJAIEM)*. Vol. 2, Issue 9. pp: 249-251. Sep. 2013.
- [BhNa16] M.Bheemalingaiah, M.M. Naidu, D.S. Rao, P. Vishvapath."Energy Aware On-Demand Multipath Routing Protocol in Mobile Ad Hoc Networks." *International Journal of Computer Networks and Wireless Communications*.Vol 6.No.5,pp:14-33.2016.
- [BiKh10] ZekiBilgin, and Bilal Khan. "A dynamic route optimization mechanism for AODV in MANETs." *Proceedings of IEEE International Conference on Communications (ICC)*. Cape Town, South Africa. May 23-27, 2010.
- [BrPe95] L. S. Brakmo, L. L. Peterson, "TCP Vegas: End to End Congestion Avoidance on a Global Internet", *IEEE Journal on Selected Areas inCommunication*, Vol. 13, pp. 1465- 1490, 1995.

- [ChCh94] Chunh Ju Chang and Ray GuangCheng, "Traffic control in an ATM network using fuzzy settheory", *Proceedings of the IEEE INFOCOM*, Vol. 3. pp.1200-1207, Toronto, Canada. Jun.12-16, 1994.
- [ChHe06] Octav Chipara, Zhimin He, Guoliang Xing, Qin Chen, Xiaorui Wang and Chenyang Lu. "Real-time Power-Aware Routing in Sensor Networks." *Proceedings of WQOS*. New Haven, CT, USA. June 19th-21th, 2006.
- [ChWe05] Jin Cheng, D. Wei, S. Low J.Bunn, H.D.Cho, J.C,Doyle and H.Newman, "FAST TCP: from theory to experiments", *IEEE Network*, Vol. 19, pp.4 – 11, 2005.
- [ChLe05] Meeyoung Cha, and D.K.Lee. "Split-n-sve Multiplexing in Wireless ad hoc Rotuing." *Proceedings of the 24th Annual Joint Conference of the IEEE Computer and Communications Societies (INFOCOM)*. Miami, March 2005.
- [ChGu12] Zhenyu Chen, Lin Guan, Xingang Wang, and Xunli Fan. "Ad hoc On-demand Multipath Distance Vector routing with Backup Route Update Mechanism." *Proceedings of IEEE 14th International Conference on High Performance Computing and Communications*.pp:908-913.Liverpool, UK. June 25-27, 2012.
- [ChVa03] Romit Roy Choudhury, and Nitin H. Vaidya. "Impact of directional antennas on ad hoc routing." *Personal Wireless Communications*. Springer BerlinHeidelberg.pp:590-600.2003.
- [ChVa04] Romit Roy Choudhury, and Nitin H. Vaidya. "Deafness: A MAC problem in ad hoc networks when using directional antennas." *Proceedings of the 12th IEEE International Conference on Network Protocols*,. Washington DC, US.Oct.5-8,2004.
- [ChTs02] Y.S. Chen, Yu Chee Tseng, Shu Ling Wang, Wen Hwa Liao and Jiang Ping Sheu. "Multi-Path Qos Routing in a Wireless Mobile Ad-Hoc Network.", *Telecommunication Systems*. Vol.19, Issue 3-4, pp:329-347. March 2002.
- [ChYa02] Romit Roy Choudhury, Xue Yang, Ram Ramanathan and Nitin Vaidya. "Using directional antennas for medium access control in ad hoc networks.", *Proceedings of the 8th Annual International Conference on Mobile Computing and Networking*.pp:59-70. Atlanta, Georgia, US. Sep. 23-28 2002.
- [DaAr08] Khaled Day, Bassel Arafah, Abderezak Touzene and Ahmed Ai Kindi. "A 3D grid position-based routing protocol for mobile Ad-hoc networks." *Proceedings of Computer and Communication Engineering (ICCCE)*.pp: 151-155. Kuala Lumpur, Malaysia. May 13-15 2008.
- [DaMu00] S.K.Das, A. Mukherjee, S. Bandyopadhyay, K.Paul and D.Saha. "Improving Quality-of-Service in Ad hoc Wireless Networks with Adaptive Multi-path Routing.", *Proceedings of IEEE Global Telecommunications Conference*. San Francisco, CA, US. Nov. 27- Dec. 1, 2000.

- [DoGk04] Mischa Dohler, Athanasios Gkelias, and Hamid Aghvami. "Resource allocation for FDMA-based regenerative multihop links." *IEEE Transactions on Wireless Communications*. Vol. 3.6, pp: 1989-1993. 2004.
- [DuWu03] Stefan Dulman, Jian Wu, and Paul Havinga. "An energy efficient multipath routing algorithm for wireless sensor networks." *Proceedings of the 6th International Symposium on Autonomous Decentralized Systems with an Emphasis on Advanced Distributed Transportation Systems*. Pisa, Italy. April 4-7, 2003.
- [DuMc06] Nandita Dukkkipati, Nick McKeown and Alexander G. Fraser, "RCP-AC congestion control to make flows complete quickly in any environment", *Proceedings of the IEEE INFOCOM*, pp.1 – 5, Barcelona, Spain. Apr.23-29, 2006.
- [FaSu06] Yinglei Fan, Fang Su, Yong Li and Huimin Xu. "A Network-aware Scalable Video Congestion Control Mechanism in Heterogeneous Wireless Networks." *Proceedings of International Multi-Conference on Computing in the Global Information Technology*. Bucharest, Romania. Aug. 1-3, 2006.
- [FeSh02] Wu Chang Feng, Kang G. Shin, Dilip D. Kandlur and Debanjan Saha, "The blue active queue management algorithms", *IEEE Transactions on Networking*, Vol.10, No.4, Aug.2002.
- [FoHi07] J. Hope Forsmann, Robert E. Hironoto, and John Svoboda. "A time-slotted on-demand routing protocol for mobile ad hoc unmanned vehicle systems." *Unmanned Systems Technology*. Vol. 6561. May, 2007
- [Gall77] R. Gallager. "A Minimum Delay Routing Algorithm Using Distributed Computation." *IEEE Transactions on Communications*. Vol.25. pp:73-85. 1977.
- [GaMa07] Sanjaya Gajurel, Behnam Malakooti, and Limin Wang. "DA-MLAR-ODTP: Directional Antenna Multipath Location Aided Routing with On Demand Transmission Power." *Proceedings of 2nd IEEE International Symposium on Wireless Pervasive Computing*, San Juan, Puerto Rico. Feb. 5-7, 2007.
- [Ghaf17] Ali Ghaffari. "Real-time routing algorithm for mobile ad hoc networks using reinforcement learning and heuristic algorithms." *Wireless Networks*. Vol. 23, Issue 3. pp:703-714. April, 2017.
- [GiEp02] Tolga Girici, and Anthony Ephremides. "Joint routing and scheduling metrics for ad hoc wireless networks." *Proceedings of Thirty-Sixth Asilomar Conference on Signals, Systems and Computers*. Pacific Grove, CA, US. Nov. 3-6, 2002.
- [GoAm00] Thomas E. Gorsuch, and Carlo Amalfitano. "Dynamic bandwidth allocation to transmit a wireless protocol across a code division multiple access (CDMA) radio link." *U.S. Patent*. No. 6. Jun 27, 2000.
- [GuYa03] Song Guo, and Oliver Yang. "Bandwidth Allocation in Wireless Ad-hoc Networks with Minimum-Energy Consumption." *Proceedings of The 14th IEEE International*

*Symposium on Personal, Indoor and Mobile Radio Communication*. Vol.2. pp. 1059-1063. Beijing, China. Sep. 7-9 ,2003.

- [GuYa06] Song Guo, and Oliver Yang. "Minimum-energy multicast in wireless ad hoc networks with adaptive antennas: MILP formulations and heuristic algorithms," *IEEE Transactions on Mobile Computing*. Vol.5.4. pp. 333-346. April ,2006.
- [HeYa15] Junxiao He, Oliver Yang, and Yifeng Zhou. "Globally Aware Network Flow Allocation Optimization based on Multipath Routing." *Proceedings of IEEE GLOBECOM 2015*. San Diego. Dec. 05th-10th, 2015.
- [HeYa17] Junxiao He, Oliver Yang, Yifeng Zhou, Omneya Issa."Multipath Routing Optimization with Interference Consideration in Wireless Ad hoc Network." *Proceedings of Ad Hoc Networks*. pp: 258-269, Ottawa, Canada. Sep 28-29. 2017.
- [HeYa18] Junxiao He, Oliver Yang, and Yifeng Zhou. " Using Flow Cost to Globally Allocate and Optimize Limited Bandwidth in Multipath Routing." *Journal of Computer Networks*. Vol. 132, pp:15-25. Feb.2018.
- [HoMo04] Jeroen Hoebeke, Ingrid Moerman, et al. "An overview of mobile ad hoc networks: applications and challenges." *Journal of Communications Network*. Vol.3.3. pp: 60-66.2014.
- [Hong06] Yang Hong, "Adaptive controller design for Internet traffic: A Control Theoretical Approach", *PhD dissertation*, University of Ottawa, 2006.
- [HoYa07] Yang Hong and Oliver W. W. Yang."Design of adaptive PI rate controller for best-effort traffic in the Internet based on phase margin", *IEEE Transactions on Parallel and Distributed Systems*, Vol. 18, No. 4, pp.550 – 561, Apr. 2007.
- [HuFa05] Xiaoxia Huang, and Yuguang Fang. "End-to-End delay differentiation by prioritized multipath routing in wireless sensor networks." *Proceedings of Military Communication Conference (MILCOM)*. Vol.2. pp:1277-1283. Atlantic City, US. Oct. 17-20, 2005.
- [HyMu07] M.T.Hyland, B.E.Mullins, R.O.Baldwin, and M.A.Temple. "Simulation based performance evaluation of mobile ad hoc routing protocols in a swarm of unmanned aerial vehicles." *Proceedings of the 21st International Conference on Advanced Information Networking and Applications*. pp:249-256. Washington, DC, USA, May 21-23, 2007.
- [Jaco90] V. Jacobson, "Modified TCP congestion avoidance algorithm", *mailing list, end-to-end-interest*, April 30, 1990.
- [JiBh05] Fang Jing, R.S. Bhuvaneshwaran, Y. Katayama, and N. Takahashi. "A multipath on-demand routing with path selection probabilities for mobile ad hoc networks." *Proceedings of the International Conference on Wireless Communications*,

*Networking and Mobile Computing*. Vol.2. pp:1145-1148. Wuhan, China. Sep. 26, 2005.

- [JiZh06] ZaihanJiang, and MengChu Zhou. "A DynamicBandwidthAllocationwithCollisionAvoidance MAC Design for Mobile Ad Hoc Network.". *Proceedings of the 2006 IEEE International Conference onNetworking, Sensing and Control*.Ft. Lauderdale, FL, USA. April 23-25, 2006.
- [JoLu99] M. JoaNg and I.T. Lu, "A Peer-to-Peer Zone-Based Two-Level Link-State Routing for Mobile Ad Hoc Networks," *IEEE J. Selected Areas in Communication*, 1999.
- [JoMa96] David B.Johnson, and David A.Maltz. "Dynamic Source Routing in Ad Hoc Wireless Networks."*Mobile Computing*.pp:153-181.1996.
- [KaTa08] Javad Kazemitabar, Vahid Tabatabaee, and Hamid Jafarkhani."Global optimal routing, scheduling and power control for multi-hop wireless networks with interference." *Coping with Interference in Wireless Networks*. pp: 59-77. Springer Netherlands, 2011.
- [KaHa02] Dina Katabi, Mark Handley and Charlie Rohrs, "Congestion control for highbandwidth-delayproduct networks", *Proceedings of the IEEE SIGCOMM*,pp.89-102, Pittsburgh, Pennsylvania, USA. Aug. 19-23, 2002.
- [KaTa11] J. Kazemitabar, V. Tabatabaee, and H. Jafarkhani."Global optimal routing, scheduling and power control for multi-hop wireless networks with interference."*Coping with Interference in Wireless Networks*. pp: 59-77. Springer Netherlands, 2011.
- [KhRo18] Mehrdad Khaledi, Arnau Rovira, Fatemeh Afghah. "On Greedy Routing in Dynamic UAV Networks". *Proceedings of IEEE SECON*.Hong Kong, China. June 28, 2018.
- [KoAb06] V. Kolar, and N.B. Abu-Ghazaleh. "A multi-commodity flow approach for globally aware routing in multi-hop wireless networks." *Proceedings ofFourth Annual IEEE International Conference on Pervasive Computing and Communications*. pp:306-317. Pisa, Italy. Mar. 13-17, 2006.
- [KeKe04] Frank Kelly, Robert Kepley, and Stan Kay. "Apparatus and method for efficient TDMA bandwidth allocation for TCP/IP satellite-based networks." *U.S. Patent*. No. 6. Dec21. 2004.
- [KeMa98] F.P.Kelly, A.K.Maulloo, and D.K.H.Tan."Rate Control inCommunication Networks: Shadow Prices, Proportional Fairnessand Stability."*J. Operational Research Soc.* Vol.49.pp:237-252.1998.
- [Kell97] Frank P.Kelly."Charging and Rate Control for Elastic Traffic."*European Trans. Telecomm*.Vol. 8.pp: 33-37.1997.

- [KrPa06] N.K.Karthikeyan Krishnasamy, and P.Narayanasamy Palanisamy. "Bandwidth allocation scheme for multimedia mobile networks using optimization techniques." *Proceedings of IEEE Conference on Cybernetics and Intelligent Systems*. pp:1-5. Bangkok, Thailand. June 7-9, 2006.
- [KiKo05] Sung-HoKim, and Young-Bae Ko. "A directional antenna based path optimization scheme for wireless ad hoc networks." *Mobile Ad-hoc and Sensor Networks*. Springer Berlin Heidelberg. pp:317-326. 2005.
- [LeGe00] S.J. Lee, M. Gerla. "SMR: Split Multipath Routing with maximally disjoint paths in ad hoc networks." *Technical report, Computer Science Department, University of California, Los Angeles*. August, 2000.
- [LeCi98] Achankeng Leke, and John M. Cioffi. "Dynamic bandwidth optimization for wireline and wireless channels." *Proceedings of IEEE Conference Record of the Thirty-Second Asilomar Conference on Signals, Systems & Computers*. Vol. 2. pp:1753-1757. Pacific Grove, CA, USA. Nov. 1-4, 1998.
- [LeKi07] Fenglien Lee, Haklin Kimm, and Craig Reinhart. "A Global On-Demand Routing Protocol for Mobile Ad Hoc Networks." *Proceedings of Sixth IEEE International Symposium on Network Computing and Applications (NCA)*. pp:261-264. Cambridge, MA. July 12-14, 2007.
- [LeLi01] R. Leung, Jilei Liu, E. Poon, A.L.C. Chan and Baochun Li. "MP-DSR: A QoS-aware Multipath Dynamic Source Routing Protocol for Wireless Ad-hoc Networks." *Proceedings of the 26th IEEE Annual Conference on Local Computer Networks*. pp:132-141. Tampa, FL, USA. Nov. 14-16, 2001.
- [LiMi05] Yibin Liang, and S.F. Midkiff. "Multipath Fresnel Zone routing for wireless ad hoc networks." *Proceedings of the IEEE Wireless Communications and Networking Conference*. Vol.4. pp:1958-1963. New Orleans, LA, USA. Mar. 13-17, 2005.
- [LiRa99] J.C. Liberti and T.S. Rappaport. "Smart Antennas for Wireless Communications." *Prentice-Hall PTR*. 1999.
- [LiSu12] Lin Lin, Qibo Sun, Jinglin Li and Fangchun Yang. "A novel geographic position mobility oriented routing strategy for UAVs." *Journal of Computational Information Systems*. Vol.8, No. 2. pp:709-716. 2012.
- [LiTs01] Wen Hwa Liao, Yu Chee Tseng, Shu Ling Wang. "A Multi-path QoS Routing Protocol in a Wireless Mobile Ad Hoc Network." *Proceedings of IEEE International Conference on Networking*. pp:158-167. Heidelberg, Berlin. Feb. 4-9, 2001.
- [LiXu03] Haejung Lim, Kaixin Xu, and M. Gerla. "TCP performance over multipath routing in mobile ad hoc networks." *Proceedings of IEEE International Conference on Communication (ICC)*. Vol.2. pp:1064-1068. Anchorage, AK, USA. May 11-15, 2003.

- [LoLa99] S.H. Low and D.E. Lapsley."Optimization Flow Control: Basic Algorithm and Convergence."*IEEE/ACM Trans on Networking*. Vol.7, No. 6.pp:861-874.1999.
- [LuLu00] Haiyun Luo, Songwu Lu, and Vaduvur Bharghavan."A New Model for Packet Scheduling in Multihop Wireless Networks."*Proceedings of ACM Mobicom Conference*.pp:76-86, Boston, USA. Aug. 6-11, 2000.
- [MaDa01] Mahesh K. Marina, and Samir R. Das. "On-demand multipath distance vector routing in ad hoc networks."*Proceedings ofIEEE Ninth International Conference on Network Protocols*. pp:14-23. Riverside, CA, USA. Nov. 11-14, 2001.
- [MaDa06] Mahesh K. Marina, and Samir R. Das. "Ad Hoc On-demand multipath distance vector routing."*Wireless Communciations and Mobile Computing*. pp:969-988. 2006.
- [MaMa14] Krishna Mahajan, Devesh Malik,M.A. Rizvi and Singh Karaulia. "Event Driven Dynamic Path Optimization for AODV in MANET." *Proceedings ofInternational Conference on Computational Intelligence and Communication Networks (CICN)*. Bhopal, India. Nov. 14-16,2014.
- [MaSe97] Mattew Mathis, Jeffrey Semke, Jamshid Mahdavi and Teunis Ott, "The Macroscopic Behavior of theTCP Congestion Avoid Algorithm", *ACM Computer Communication Review*,Vol. 27, No. 3, July 1997.
- [MoAl10] Sandro Moiron, Ismail Ali,Martin Fleury and Mohammed Ghanbari. "A prioritization scheme for H. 264/AVC video congestion resilience with IEEE 802.11 e." *Proceedings of IEEE 6th Conference on Wireless Advanced (WiAD)*. London, UK. June 27-29, 2010.
- [MuGa96] Shree Murthy, and J.J. Garcia-Luna-Aceves. "An Efficient Routing Protocol for Wireless Networks."*App.J. Special Issue on Routing in MobileCommunication Networks*. Vol.1(3).pp:183-197. Oct. 1996.
- [MuTs04] Stephen Mueller, Rose P. Tsang, and Dipak Ghosal. "Multipath routing in mobile ad hoc networks: Issues and challenges." *Performance Tools and Applications to Networked Systems*. Springer BerlinHeidelberg. pp: 209-234. 2004.
- [NaDa99] A. Nasipuri, and S.R. Das."On-Demand Multipath Routing for MOBILE Ad Hoc Networks." *Proceedings of the 8th International Conference on Computer Communication and Networks*. Boston, USA. Oct. 11-13,1999.
- [NaMa00] Asis Nasipuri, J. Mandava, et al. "On-demand routing using directional antennas in mobile ad hoc networks." *Proceedings of IEEE Ninth International Conference onComputer Communications and Networks*.Las Vegas, USA. Oct.16-18, 2000.
- [NaKi00] Thyagarajan Nandagopal, Tae Eun Kim, Xia Gao and Vaduvur Bharghavan. "Achieving MAC Layer Fairness in Wireless Packet Networks."*Proceedings of ACM Mobicom Conference*.pp:87-98. Boston, USA. Aug. 6-11, 2000.

- [NiCh06] B. Nick, Cheng Jin, S. H. Low and S. Hegde, "FAST TCP: motivation, architecture, algorithms, performance", *IEEE/ACM Transactions on Networking*, Vol.14, No.6, pp. 1246–1259, 2006.
- [NoLe13] Youngtae Noh, Uichin Lee, Paul Wang, Brian Sung Chul Choi, and Mario Gerla. "VAPR: Void-aware pressure routing for underwater sensor networks." *IEEE Transactions on Mobile Computing*. Vol 12, No 5. pp:895-908.2013.
- [PeBh94] Charles E. Perkins, and Pravin Bhagwat. "Highly dynamic destination-sequenced distance vector routing for mobile computers." *Proceedings of SIGCOMM*. pp:234-244. London, UK. Aug. 31- Sep. 02, 1994.
- [PeRo99] Charles E. Perkins, and Elizabeth M. Royer. "Ad-hoc On-Demand Distance Vector Routing." *Proceedings of the 2<sup>nd</sup> IEEE Workshop on Mobile Computing Systems and Applications*. Washington DC, USA. Feb. 25-26, 1999.
- [PiSu12] Shangchao Pi, and Baolin Sun. "Fuzzy controllers based multipath routing algorithm in MANET". *Physic Procedia*, Vol. 24. pp: 1178-1185. 2012.
- [PhPe03] P.P. Pham, S. Perrau. "Performance analysis of reactive shortest path and multipath routing mechanism with load balance." *Proceedings of the IEEE INFOCOM*. San Francisco, California, USA. pp:251-259. April, 2003.
- [QiMa03] Ying Qiu, and Peter Marbach. "Bandwidth allocation in ad hoc networks: A price-based approach." *Proceedings of IEEE INFOCOM*. Vol. 2. San Francisco, USA. Mar. 30- Apr. 03, 2003.
- [RaBa14] L. Raja, and S. Santhosh Baboo. "An Overview of MANET: Applications, Attacks and Challenges." *International Journal of Computer Science and Mobile Computing*. Vol3 Issue 1. pp: 408-417. January, 2014.
- [Rama01] Ram Ramanathan. "On the performance of ad hoc networks with beamforming antennas." *Proceedings of the 2nd ACM International Symposium on Mobile Ad hoc Networking & Computing*. pp:95-105. New York, USA. Oct. 04-05, 2001.
- [RoRa15] Y. Harold Robinson, M. Rajaram. "Energy-Aware Multipath Routing Scheme Based on Particle Swarm Optimization in Mobile Ad Ho Networks". *The Scientific World Journal*. Volume 2015.
- [SaCa16] Baugh Samuel, Gruia Calinescu, David Rincon Cruz, and Kan Qiao. "Improved Algorithms for Two Energy-Optimal Routing Problems in Ad-Hoc Wireless Networks." *Proceedings of IEEE International Conferences on BDCloud, SocialCom, and SustainCom*. Atlanta, USA. Oct. 08-10, 2016.
- [SaJo04] Amit Kumar Saha, and David B. Johnson. "Routing improvement using directional antennas in mobile ad hoc networks." *Proceedings of IEEE GLOBECOM* Vol. 5. Dallas, USA. Nov. 29- Dec. 03., 2004.

- [SeLa14] Dev Aksatha D. Seema, and T. Lalitha. "A Comprehensive Overview on Manet." *IJEAT: International Journal of Engineering and Advanced Technology*. Vol. 3, Issue 6. pp:242-244. Aug. 2014.
- [SeHn12] Adarshpal S.Sethi, Vasil Y.Hnatyshin. *The Practical OPNET User Guide for Computer Network Simulation*.
- [ShSt11] Rostam Shirani, Marc St-Hilaire, Thomas Kunz, Yifeng Zhou, Jun LI and Louise Lamont. "The performance of greedy geographic forwarding in unmanned aeronautical ad hoc networks." *Proceedings of the 9th Annual Communication Networks and Services Research Conference*. pp:161-166. Ottawa, Canada, May 2-5, 2011.
- [SpRa02] A. Spyropoulos, and C.S. Raghavendra, "Energy Efficient Communications in Ad Hoc Networks Using Directional Antennas." . *Proceedings of Twenty-First Annual Joint Conference of the IEEE Computer and Communications Societies*. Vol.1. pp. 220–228, New York, USA. June 23-27, 2002.
- [SiWo98] Suresh Singh, Mike Woo, and C. S. Raghavendra. "Power-aware routing in mobile ad hoc networks." *Proceedings of IEEE international conference on Mobile computing and networking*. Vol.4,pp:181-190. Dallas, Texas. Oct. 25-30, 1998.
- [ShKi14] Babar Shah, and Ki-II Kim. "A Survey on Three-Dimensional Wireless Ad Hoc and Sensor Networks." *International Journal of Distributed Sensor Networks*. Vol. 2014 ID 616014. 2014.
- [ShCh06] Kuei-Ping Shih, Chih-Yung Chang, et al. "Dynamic bandwidth allocation for QoS routing on TDMA-based mobile ad hoc networks." *Computer Communications*. Vol. 29.9. pp: 1316-1329.2006.
- [Stal03] William Stallings, *Data and Computer Communications*, 7th Edition, PrenticeHall, 2003
- [SeZh04] Eric Setton, Xiaoqing Zhu, and Bernd Girod. "Congestion-optimized multi-path streaming of video over ad hoc wireless networks." *2004 IEEE International Conference on Multimedia and Expo*. Vol. 3. 2004.
- [ShZh13] JianShen, Wenying Zheng, et al. "Routing Protocols using Directional Antennas in Ad Hoc Networks: A Comparative Review." *International Journal of Grid and Distributed Computing* 6.5. pp: 39-50. 2013.
- [TaTe09] Mohammed Tarique, Kemal E. Tepe, Sasan Adibi and Shervin Erfani. "Survey of multipath routing protocols for mobile ad hoc networks." *Journal of Network and Computer Applications*. Vol.32.6. pp:1125-1143. 2009
- [TaSa02] L. Tassiulas and S. Sarkar. "Maxmin Fair Scheduling in Wireless Networks." *Proceedings of IEEE INFOCOM Conference*. pp:763-772. New York, USA. June 23-27, 2002.

- [TaSe07] Hwee Pink Tan, Winston K.G.Seah, and Linda Doyle. "A multi-hop ARQ protocol for underwater acoustic networks." *Proceedings of the Oceans*. pp:1-6. Aberdeen, Scotland. June 18-21, 2007.
- [TiUp02] Ting-ChungTien, and Shambhu J. Upadhyaya. "A local/global strategy based on signal strength for message routing in wireless mobile ad-hoc networks." *Mobile Computing*. pp:191-212. Springer US, 2002.
- [TsMo06] Jack Tsai, and Tim Moors. "A review of multipath routing protocols: From wireless ad hoc to mesh networks." *Early Career Researcher Workshop on Wireless Multihop Networking*. Vol. 30. 2006.
- [VaBe00] A.Vahdat, D. Becker. "Epidemic routing for partially connected Ad Hoc Networks." *Tecg, Rep*,2000.
- [Vand93] LucVandendorpe. "Multitone system in an unlimited bandwidth multipath Rician fading environment." *Proceedings of Sixth International Conference on Mobile and Personal Communications*.Brighton, UK. Dec. 13-15,1993.
- [VaSe03] A. Valera, W.K.G. Seah, S.V. Rao."Cooperative Packet Caching and SHortest Multipath Routing in Mobile Ad Hoc Networks."*Proceedings ofIEEE INFOCOM*. San Francisco, USA. Mar. 30- Apr. 03, 2003
- [ViAl11] Luiz Filipe M. Vieira, Marcelo G. Almiron, and Antonio AF Loureiro. "3D MANETs: link probability, node degree, network coverage and applications."*Proceedings ofIEEE Wireless Communications and Networking Conference (WCNC)*. pp: 2042-2047. Cancun, Quintana Roo. Mar.28-31,2011.
- [VuGa99] Srinivas Vutukury and J.J. Garcia-Luna-Aceves. "A simple approximation to minimum-delay routing." *Proceedings of the conference on Applications, Technologies, Architectures, and Protocols for Computer Communication*.pp:227-238. Cambridge, MassachusettsUSA. Aug. 30-Sep. 03, 1999.
- [WaHs08] ShengShuen Wang, and Hsu-Feng Hsiao. "TCP-friendly congestion control for layered video streaming using end-to-end bandwidth inference." *Proceedings of IEEE 10th Workshop on Multimedia Signal Processing*. Cairns, Qld, Australia. Oct. 8-10, 2008.
- [WaZh00] Lei Wang, Lianfang Zhang, Yantai Shu, and Miao Dong."Multipath Source Routing in Wireless Ad hoc Networks."*Proceedings ofCanadian Conference on Electrical and Computer Engineering*. Vol.1. pp:479-483.Halifax, Canada. May 7-10, 2000.
- [WaZh01] Lei Wang, Lianfang Zhang, Yantai Shu, Miao Dong, Oliver Yang. "Adaptive Multipath Source Routing in Ad hoc Networks." *Proceedings ofIEEE InternationalConference onCommunications*.Vol. 3. pp:867-871. Helsinki, Finland.June 11-14, 2001

- [XiCu06] Peng Xie, Jun Hong Cui, and Li Lao. "VBF: Vector-based forwarding protocol for underwater sensor networks, networking technologies, services and protocols." *Proceedings of NTSP*. pp:1216-1221. Berlin, Germany.2006.
- [YiJi07] Jiazi Yi. "Summary of Routing Protocols in Mobile Ad Hoc Networks." *PolytechnicSchool of University of Nantes* (2007).
- [YeKr03] Z.Ye, S.V.Krishnamurthy, S.K. Tripathi."A Framework for Reliable Routing in Mobile Ad Hoc Networks." *Proceedings of IEEE INFORCOM*. San Francisco, USA. Mar. 30- Apr. 03, 2003
- [Wiki15a] [https://en.wikipedia.org/wiki/Smart\\_antenna](https://en.wikipedia.org/wiki/Smart_antenna), available as of June. 20, 2015.
- [Wiki15b] [https://en.wikipedia.org/wiki/Multipath\\_routing](https://en.wikipedia.org/wiki/Multipath_routing), available as of July. 07, 2015.
- [ZaEi09] Aniss Zakaria, and Randa Ei-Marakby. "AdamRTP: Adaptive Multi-flows Real-time Multimedia Delivery over WSNs." *Proceedings of ISSPIT*. Ajman, United Arab Emirates. Dec. 14th-17th, 2009.
- [ZhJi14] Liulin Zhong, Ming'e Jing, Zhiyi Yu, and Xiaoyang Zeng. "A global-aware bandwidth-constraint routing scheme for Network-on-Chip." *Proceedings of 12th IEEE International Conference on Solid-State and Integrated Circuit Technology (ICSICT)*. pp:1-3. Guilin, China. Oct. 28-31, 2014.
- [ZhHo05] HonghaiZhang. and Jennifer C. Hou. "Capacity of wireless ad-hoc networks under ultra wide band with power constraint." *Proceedings of 24th Annual Joint Conference of the IEEE Computer and Communications Societies*. Vol. 1. Miami, USA. Mar. 13-17, 2005.
- [ZhKa07] Lei Zhao, Baoqiang Kan, Yongjun Xu, and Xiaowei Li. "FT-SPEED: A Fault-Tolerant, Real-Time Routing Protocol for Wireless Sensor Networks." *Proceedings of WICOM*. Shanghai, China. Sep. 21th-25th, 2007.
- [ZhXu13] Jieying Zhou, Heng Xu, Zhaodong Qin, Yanhao Peng, and Chun Lei. "Ad Hoc On-Demand Multipath Distance Vector Routing Protocol Based on NodeState." *Communications and Network*. Vol.5.03. pp: 408-413. 2013.
- [ZoCa08] Mo.Zorzi, Paolo Casari, Nicola Baldo and Albert F.Harris. "Energy efficient routing schemes for underwater acoustic networks." *IEEE journal on Selected Areas in Communications*. Vol 26. pp:1754-1766,2008.

## **Appendix: OPNET Introduction [SeHn12]**

OPNET stands for OPTimized Network Engineering Tool and is one the most popular network simulation and modeling tools. A number of different models can be created to simulate, analyze and compare their results. It is an object oriented discrete event simulator, which is scalable and gives efficient simulation results. It helps to improve performance, availability and optimize cost of network design. It enables network designers to design network topologies using in-built emulated devices/objects, protocols applications and also provides great flexibility to analyzed network performance. It comes with graphical user interface, which provides a platform to model network topology at any layer of the Open Systems Interconnection(OSI) model. Simulation can be run in the debugging mode to resolve compilation, simulation and modeling errors.

Modeler has three hierarchical levels: Project Editor, Node Model and Process Model. Project editor is an editing platform where network models can be created as per specific network topology requirements using in-built objects. Modeler provides varieties of statistics to choose from such as node statistics, link statistics and global statistics. Node model represents architecture of individual devices like router, switches, and computer etc. based on OSI layer. Process model is the lowest abstraction level, which provides basic functionality of configured protocols. It can also be possible to modify behavior of protocols by editing the process models associated with that particular protocol. Simulation can be configured using two tools: one is using “Configure Simulation” and the other is “Advance Configure Simulation” which provides multiple options to run simulation as per network demands. It also provides number of analysis methods such as time average, mean value etc. with graphical presentation.