



uOttawa

L'Université canadienne  
Canada's university

FACULTÉ DES ÉTUDES SUPÉRIEURES  
ET POSTDOCTORALES



FACULTY OF GRADUATE AND  
POSTDOCTORAL STUDIES

**Bo Jiang**

AUTEUR DE LA THÈSE / AUTHOR OF THESIS

**Master of Computer Science**

GRADE / DEGREE

**School of Information Technology and Engineering**

FACULTÉ, ÉCOLE, DÉPARTEMENT / FACULTY, SCHOOL, DEPARTMENT

**Combining Graphical Scenarios with a Requirements Management System**

TITRE DE LA THÈSE / TITLE OF THESIS

**Daniel Amyot**

DIRECTEUR (DIRECTRICE) DE LA THÈSE / THESIS SUPERVISOR

**Robert Probert**

CO-DIRECTEUR (CO-DIRECTRICE) DE LA THÈSE / THESIS CO-SUPERVISOR

**EXAMINATEURS (EXAMINATRICES) DE LA THÈSE / THESIS EXAMINERS**

**Stéphane Somé**

**Michael Weiss**

**Gary W. Slater**

LE DOYEN DE LA FACULTÉ DES ÉTUDES SUPÉRIEURES ET POSTDOCTORALES /  
DEAN OF THE FACULTY OF GRADUATE AND POSTDOCTORAL STUDIES

# Combining Graphical Scenarios with a Requirements Management System

**Bo Jiang**

Thesis submitted to the  
Faculty of Graduate and Postdoctoral Studies  
in partial fulfillment of the requirements for the degree of

**Master of Computer Science**

Under the auspices of the Ottawa-Carleton Institute for Computer Science



University of Ottawa  
Ottawa, Ontario, Canada  
June 2005

© Bo Jiang, Ottawa, Canada, 2005



Library and  
Archives Canada

Bibliothèque et  
Archives Canada

Published Heritage  
Branch

Direction du  
Patrimoine de l'édition

395 Wellington Street  
Ottawa ON K1A 0N4  
Canada

395, rue Wellington  
Ottawa ON K1A 0N4  
Canada

*Your file* *Votre référence*

*ISBN: 0-494-11305-7*

*Our file* *Notre référence*

*ISBN: 0-494-11305-7*

#### NOTICE:

The author has granted a non-exclusive license allowing Library and Archives Canada to reproduce, publish, archive, preserve, conserve, communicate to the public by telecommunication or on the Internet, loan, distribute and sell theses worldwide, for commercial or non-commercial purposes, in microform, paper, electronic and/or any other formats.

The author retains copyright ownership and moral rights in this thesis. Neither the thesis nor substantial extracts from it may be printed or otherwise reproduced without the author's permission.

#### AVIS:

L'auteur a accordé une licence non exclusive permettant à la Bibliothèque et Archives Canada de reproduire, publier, archiver, sauvegarder, conserver, transmettre au public par télécommunication ou par l'Internet, prêter, distribuer et vendre des thèses partout dans le monde, à des fins commerciales ou autres, sur support microforme, papier, électronique et/ou autres formats.

L'auteur conserve la propriété du droit d'auteur et des droits moraux qui protègent cette thèse. Ni la thèse ni des extraits substantiels de celle-ci ne doivent être imprimés ou autrement reproduits sans son autorisation.

---

In compliance with the Canadian Privacy Act some supporting forms may have been removed from this thesis.

Conformément à la loi canadienne sur la protection de la vie privée, quelques formulaires secondaires ont été enlevés de cette thèse.

While these forms may be included in the document page count, their removal does not represent any loss of content from the thesis.

Bien que ces formulaires aient inclus dans la pagination, il n'y aura aucun contenu manquant.

  
**Canada**

# Abstract

---

Scenarios have gained in popularity for the description of functional requirements. However, scenarios cannot specify all types of requirements, and often they are expressed separately from other requirements. In order for scenarios to be used in cooperation with complementary general requirements, both views must be linked in a way that supports traceability, navigation, and analysis. This thesis proposes an approach to introduce graphical scenarios (represented as Use Case Maps – UCMs) into a requirements management system (namely, Telelogic DOORS) and to maintain relationships from and to external requirements as both views evolve over time.

In the first part of the thesis, an export mechanism is added to the Use Case Map Navigator tool that enables the export of UCM models in a format that can be understood by the target requirements management system, i.e., DOORS.

In the second part of the thesis, DOORS is enhanced with an import mechanism to create or update UCM models based on the information generated by the UCM tool.

Finally, the approach is illustrated with a case study (a supply chain management business process) that demonstrates how the UCM model, the external requirements, and their links can be kept consistent as both views evolve.

# Acknowledgment

---

I would like to express my deepest gratitude to my supervisor, Dr. Daniel Amyot, who provided invaluable help and unselfish support throughout the preparation of this thesis. Without his pithy comments, insight suggestions, and extremely patient review, this thesis could never have been completed. **Thank You, Daniel!** It has been a most rewarding learning experience to work under your guidance.

I would like to thank Professor Murray Woodside and Dorin Petriu for their work and suggestions related to this research project, and especially for the initial code provided by Dorin. I wish to thank Gunter Mussbacher who tested my implementation, fixed many bugs, and gave me useful suggestions on setting up the experiment in this thesis. I would also like to express my gratitude to Professor Robert L. Probert, my co-supervisor, for his heartfelt encouragements.

This research was supported by the Natural Sciences and Engineering Research Council of Canada, through its programs of Collaborative Research and Development Grants. I am grateful to Telelogic for making their tools available via the ASERT lab, and I would like to acknowledge the great technical support provided by Chris Sibbald and his team at Telelogic and by Jacques Sincennes here at the University of Ottawa.

Finally, I would like to express my eternal gratitude to my parents, for their endless love. I would like to dedicate this thesis to the most important people in my life: my wife, Fengbing Zhang, and my daughter, Kaitlyn Jiang.

# Table of Contents

---

<b>Abstract</b> .....	<b>i</b>
<b>Acknowledgment</b> .....	<b>ii</b>
<b>Table of Contents</b> .....	<b>iii</b>
<b>List of Figures</b> .....	<b>vi</b>
<b>List of Tables</b> .....	<b>viii</b>
<b>List of Acronyms</b> .....	<b>ix</b>
<b>Chapter 1. Introduction</b> .....	<b>1</b>
1.1. <i>Motivation</i> .....	1
1.2. <i>Thesis Goals and Suggested Approach</i> .....	2
1.3. <i>Thesis Contributions</i> .....	5
1.4. <i>Thesis Outline</i> .....	5
<b>Chapter 2. Background</b> .....	<b>6</b>
2.1. <i>Scenario Notations</i> .....	6
2.1.1 Scenarios .....	6
2.1.2 Use Case Maps .....	6
2.1.3 UCMNAV .....	9
2.2. <i>Requirements Management Systems</i> .....	10
2.2.1 General Characteristics.....	10
2.2.2 Telelogic DOORS .....	10
2.2.3 DXL.....	13
2.3. <i>Scenarios and RMS</i> .....	14
2.3.1 Scenario Plus .....	14
2.3.2 DOORS/Analyst.....	16
2.4. <i>Chapter Summary</i> .....	18
<b>Chapter 3. Exporting UCM Model from UCMNAV</b> .....	<b>19</b>
3.1. <i>UCM Metamodel</i> .....	19
3.1.1 Understanding UCMs.....	19
3.1.2 Creating the UCM Metamodel .....	20
3.1.3 Principles for Exporting UCM Models .....	25

3.2.	<i>Exporting Strategies</i> .....	28
3.2.1	Generating DXL Scripts Directly From UCMNAV.....	29
3.2.2	Alternative Strategies .....	30
3.3.	<i>Core Elements and Their Associations</i> .....	32
3.3.1	Metamodel.....	32
3.3.2	Class Specification .....	32
3.3.3	Sample of DXL Scripts on UCM Core Model .....	34
3.4.	<i>Maps and Their Associations</i> .....	35
3.4.1	Metamodel.....	35
3.4.2	Class Specifications.....	36
3.4.3	Sample of DXL Script for a Map Model.....	38
3.5.	<i>Scenarios and Their Associations</i> .....	39
3.5.1	Metamodel.....	39
3.5.2	Class Specification .....	40
3.5.3	Sample of UCM Scenarios Scripts .....	44
3.6.	<i>Implementation of the Export</i> .....	45
3.7.	<i>Chapter Summary</i> .....	46
<b>Chapter 4. Importing UCM Models in DOORS .....</b>		<b>48</b>
4.1.	<i>Metamodel of the UCM model in DOORS</i> .....	48
4.2.	<i>DXL Library in DOORS</i> .....	50
4.2.1	Core .....	50
4.2.2	Maps .....	54
4.2.3	Scenarios .....	59
4.3.	<i>Automatic Link Creation</i> .....	65
4.4.	<i>Chapter Summary</i> .....	67
<b>Chapter 5. Managing the Evolution of Scenarios and Requirements.....</b>		<b>68</b>
5.1.	<i>Links from/to External Requirements</i> .....	68
5.2.	<i>Evolving UCM Models According to Changed Requirements</i> .....	71
5.2.1	Generating the Changed Requirements from DOORS .....	72
5.2.2	Evolving the UCM Model in UCMNAV .....	73
5.3.	<i>Evolving the DOORS View According to Changed UCM</i> .....	74
5.3.1	Algorithm for Managing Evolving UCM Elements .....	75
5.3.2	Managing Evolving UCM Links with External Requirements .....	77
5.4.	<i>Chapter Summary</i> .....	78
<b>Chapter 6. Case Study: Supply Chain Management.....</b>		<b>79</b>
6.1.	<i>Initial Requirements for SCM</i> .....	79
6.1.1	User Requirements .....	80
6.1.2	System Requirements .....	82
6.1.3	Test Requirements .....	82

6.2.	<i>UCM Model for SCM</i> .....	84
6.3.	<i>Managing Changes to the UCM Model</i> .....	88
6.3.1	Addition of New Maps and Core Elements.....	89
6.3.2	Addition of New Scenarios .....	89
6.3.3	Deletion of Maps .....	91
6.3.4	Deletion of Scenarios .....	92
6.3.5	Modification to Maps .....	93
6.3.6	Modification to Scenarios.....	94
6.4.	<i>Managing Changes to External Requirements</i> .....	95
6.5.	<i>Discussion</i> .....	96
6.5.1	Benefits and Limitations.....	96
6.5.2	Comparison with Other Tools .....	97
6.6.	<i>Chapter Summary</i> .....	99
<b>Chapter 7. Conclusions</b> .....		<b>100</b>
7.1.	<i>Contributions</i> .....	100
7.2.	<i>Future work</i> .....	101
<b>References</b> .....		<b>103</b>
<b>Appendix A: System Requirements of SCM</b> .....		<b>106</b>
<b>Appendix B: Sample API Function in DXL</b> .....		<b>108</b>
<b>Appendix C: UCM Model for the Supply Chain Management</b> .....		<b>110</b>

# List of Figures

---

<b>Figure 1</b>	Iterative evolution of UCM models and requirements.....	4
<b>Figure 2</b>	A simple UCM.....	8
<b>Figure 3</b>	UCMNAV, the Use Case Map Navigator tool.....	9
<b>Figure 4</b>	DOORS database view.....	11
<b>Figure 5</b>	View of formal module.....	12
<b>Figure 6</b>	Sample of DXL code.....	13
<b>Figure 7</b>	Scenario Plus: Use case editor.....	15
<b>Figure 8</b>	Scenario Plus: Use case module in DOORS.....	15
<b>Figure 9</b>	DOORS/Analyst: Class diagram in editor.....	16
<b>Figure 10</b>	DOORS/Analyst: Class diagram in formal module.....	17
<b>Figure 11</b>	DOORS/Analyst: Sequence diagram in formal module.....	18
<b>Figure 12</b>	Overview of the UCM metamodel based the Z.152 and scenario DTDs.....	21
<b>Figure 13</b>	Top package of UCM metamodel.....	21
<b>Figure 14</b>	Path package of UCM metamodel (1).....	22
<b>Figure 15</b>	Path package of UCM metamodel (2).....	23
<b>Figure 16</b>	Scenario package of UCM metamodel.....	24
<b>Figure 17</b>	Performance package of UCM metamodel.....	25
<b>Figure 18</b>	Metamodel of exported UCM models.....	27
<b>Figure 19</b>	Generating and importing DXL scripts.....	30
<b>Figure 20</b>	DXL script example.....	30
<b>Figure 21</b>	Generating DXL scripts via XML.....	31
<b>Figure 22</b>	Core elements metamodel of exported UCM.....	32
<b>Figure 23</b>	DXL script for the core elements in the Simple Telephone System.....	34
<b>Figure 24</b>	Map metamodel of exported UCM.....	35
<b>Figure 25</b>	Root map in the Simple Telephone System.....	38
<b>Figure 26</b>	DXL script generated for the Root map in the Simple Telephone System..	39
<b>Figure 27</b>	Scenario metamodel of exported UCM.....	40
<b>Figure 28</b>	Successful Basic Call Scenario in the Simple Telephone System.....	44
<b>Figure 29</b>	DXL script of the successful BasicCall scenario.....	45
<b>Figure 30</b>	UCM metamodel in DOORS.....	49
<b>Figure 31</b>	Core folder for the Simple Telephone example in DOORS.....	53
<b>Figure 32</b>	Maps for the Simple Telephone System in DOORS.....	59
<b>Figure 33</b>	Scenarios for the Simple Telephone System in DOORS.....	64
<b>Figure 34</b>	Internal links in an imported UCM model.....	66
<b>Figure 35</b>	Links between a UCM model and external requirements.....	70
<b>Figure 36</b>	Suspect links between a UCM model and external requirements.....	72
<b>Figure 37</b>	Report on changed requirements generated by DOORS.....	73
<b>Figure 38</b>	The modified UCM model.....	74
<b>Figure 39</b>	UCM maps for SCM.....	85

<b>Figure 40</b>	UCM scenarios for SCM.....	85
<b>Figure 41</b>	Traceability view from user requirements .....	86
<b>Figure 42</b>	Scenarios traceability view.....	87
<b>Figure 43</b>	New maps and core elements .....	89
<b>Figure 44</b>	New scenarios after the update.....	90
<b>Figure 45</b>	Adding links between new UCM maps to/from external requirements.....	91
<b>Figure 46</b>	Exceptions generated while deleting maps .....	92
<b>Figure 47</b>	Exceptions generated while deleting scenarios.....	92
<b>Figure 48</b>	Triggering suspect links in user requirements.....	93
<b>Figure 49</b>	Triggering suspect out-links in system requirements.....	94
<b>Figure 50</b>	Triggering suspect out-links in test cases.....	94
<b>Figure 51</b>	Reporting changed requirements to UCMNAV .....	95

## List of Tables

---

<b>Table 1</b>	Traceability between the UCM metamodel and the exported subset.....	28
<b>Table 2</b>	Mapping from metamodel associations to DOORS links .....	66
<b>Table 3</b>	Attributes not affecting histories, suspect links, and the notification bar ....	76
<b>Table 4</b>	Actors participating to the use cases .....	80
<b>Table 5</b>	Primary path of Use Case 3.....	81
<b>Table 6</b>	Exception path of Use Case 3 .....	82
<b>Table 7</b>	Functional requirements related with Use Case 3: Replenish Stock.....	82
<b>Table 8</b>	Test cases for SCM (adapted from [38]).....	83
<b>Table 9</b>	Changes applied on the first UCM model for SCM.....	88

# List of Acronyms

---

<b>Acronym</b>	<b>Definition</b>
API	Application Programming Interface
BMP	Windows Bitmap
DOORS	Distributed Object-Oriented Requirements System
DTD	Document Type Definition
DXL	DOORS eXtended Language
EPS	Encapsulated PostScript
ID	Identifier
ITU	International Telecommunications Union
LQN	Layered Queueing Network
MSC	Message Sequence Chart
NFR	Non-Functional Requirement
RMS	Requirements Management System
SCM	Supply Chain Management
SD	Sequence Diagram
UCM	Use Case Map
UCMNAV	Use Case Map Navigator
UML	Unified Modeling Language
URN	User Requirements Notation
WMF	Windows Meta File
WS-I	Web Services Interoperability
XMI	XML Metadata Interchange
XML	eXtensible Markup Language

# Chapter 1. Introduction

---

This thesis describes and illustrates a tool-supported integration between a visual scenario modeling language and a requirements management system. This chapter presents the motivation for this work and highlights the thesis contributions.

## 1.1. Motivation

*Requirements* are expressions of ideas to be embodied in the system or product under development and the conditions under which it will operate. Requirements for a given product are frequently divided into user requirements, system requirements, and testing requirements, and often we see a distinction between functional requirements and non-functional requirements. Requirements are collected in unconstrained forms including text, diagrams, tables, and equations or logical formulae. Requirements analysis then uses various techniques to investigate the consistency, completeness, feasibility, and consequences of the requirements. Nuseibeh and Easterbrook discuss integrated requirements engineering, combining a variety of techniques with automated tool support for effective requirements management [25]. In particular, they identify the need to move from contextual enquiry to elicit requirements, to more formal representations for analysis.

Requirements do not exist in isolation. They may have various kinds of relationships such as dependencies, refinement, or satisfaction, and these are often supported by tools with typed traceability links. Changing one requirement may affect requirements linked to it, hence the need for traceability relationships. In practice, requirements are likely to change during the development process. To keep requirements consistent during their evolution, a *requirements management system* (RMS) is often used to organize those requirements with support for traceability, access control, and version control.

*Scenarios* are one form of interesting and popular requirement representation. They describe sequences of operations to be carried out in response to given events, requests, or interactions. Scenarios are known to help describing functional and operational

requirements, uncovering hidden requirements and trade-offs, as well as validating and verifying requirements. Scenarios can also be applied to requirements for different development stages, including user requirements, system requirements, and testing requirements. Lamsweerde gives a thorough discussion on the relationships between scenarios and other requirements models [22]. Like many others, he noted that scenario specifications are incomplete and cannot be used as substitutes for all types of requirements. Complementary non-functional requirements, goals, quality attributes, and informal annotations are found in most requirements documents.

Scenarios, like requirements, often evolve over time. *Scenario management* and *scenario evolution*, which are discussed thoroughly by Jarke *et al.* [21], face the issue of maintaining traceability of related and evolving scenarios. To avoid an explosion in the number of individual scenarios describing a complex system, several approaches have been developed to capture common parts (often called *episodes*) and describe interdependencies through relationships such as precedence, alternatives, inclusion, extension, usage, etc., while at the same time improving consistency and maintainability. Breitman and Leite provided an extensive case study on scenario evolution based on such relationships, and they identified the need to develop suitable management systems that would take into consideration scenario relationships [11]. However, how best to integrate *graphical* scenarios with other types of requirements, with tool support, remains an issue.

Due to lack of requirements management mechanism, graphical scenarios tool manage the evolution of scenarios by having different and separate versions, and by recording the relationships with other requirements in natural language or with tables through some text editor or word processor. This manual way cannot handle the management of requirements in complex systems properly. The completeness and consistency of requirements become hard goals to achieve and require much manual work. The links are also difficult to exploit during analysis.

## **1.2. Thesis Goals and Suggested Approach**

In order for scenarios to be used in cooperation with general requirements, they must be connected to each other in a way that supports efficient traceability, navigation, and

analysis. Hence, this thesis proposes an approach to introduce graphical scenarios and their elements into a RMS, where their links and their evolution will be managed.

In this approach, the evolution of scenarios and other requirements can be intertwined in many ways. Typically, scenarios will be used to discover requirements or to provide an operational view of existing requirements for understanding and validation. In turn, external requirements can also trigger the discovery or evolution of scenarios.

In order for this approach to be prototyped and validated, we have selected a specific scenario language and a specific requirements management system. Given its high flexibility and its popularity, Telelogic DOORS is chosen as the RMS in this study. DOORS is a collaborative application for requirements capture, management, and analysis [32]. It can also be easily extended through its proprietary scripting language called DXL.

The Use Case Map (UCM) language [12][13][20] will act as the candidate scenario notation in this thesis. UCMs describe multiple scenarios in a single, integrated view, as well as the relationships between scenarios and their underlying architecture. This promotes the understanding and reasoning about the system as a whole, as well as the early detection of conflicting or inconsistent scenarios [7]. The most popular tool supporting the UCM notation is the open-source UCM Navigator (UCMNAV, [24]).

Interestingly, Use Case Maps contain many of the relationships discussed by Breitman and Leite [11] as first-class language constructs. Unfortunately, few substantial results are available for either the management of graphical scenarios like UCMs, or their integration to general requirements. This thesis hence intends to provide a tool-supported framework where these concepts could be explored and researched further.



### 1.3. Thesis Contributions

This thesis offers four major contributions:

- Abstraction of a UCM metamodel from various sources (in collaboration with Y.X. Zeng);
- Definition of a UCM-to-DOORS export mechanism based on DXL and implemented in UCMNAV;
- Creation of a UCM import/update mechanism in DOORS, with analysis and reporting facilities;
- Illustrative experiment involving a UCM model and other requirements that evolve over time, and where the various links are maintained and exploited for requirements analysis.

### 1.4. Thesis Outline

This thesis is structured as follows:

- Chapter 2 presents the general concepts, notations, and tools used in the thesis.
- Chapter 3 details how UCMNAV is enhanced to support the generation of DXL scripts describing relevant aspects of UCM models as well as their relationships.
- Chapter 4 describes the DOORS DXL library used to import UCM models described as DXL scripts.
- Chapter 5 describes how UCM models are linked with other requirements in DOORS, and how their evolutions affect each other.
- Chapter 6 demonstrates the improvement of requirements consistency and completeness by applying the proposed approach on a supply chain management case study.
- Finally, chapter 7 recalls the main contributions of the thesis and provides some directions for future research.

## Chapter 2. Background

---

### 2.1. Scenario Notations

#### 2.1.1 Scenarios

The term *scenarios* used in this thesis means sequences of actions a system performs in various conditions. The concept is similar to the term *use cases* in UML [26]. However, scenarios are usually more precise and concrete than use cases (the latter are often abstract and include multiple scenarios). Scenarios can be used not only to describe functional requirements, but also to validate and verify requirements as test goals. More importantly, scenarios can work as a start point to drive the design, the testing, the overall validation, and the evolution of systems [4]. Scenario-based approaches are now widely used in industry to specify various types of systems. The following section introduces the requirement description technique is used in this thesis, namely Use Case Maps.

#### 2.1.2 Use Case Maps

Use Case Map (UCM) [12][13] is a scenario-based and visual notation for gathering requirements, specifying design, and conducting testing. UCM is used by a growing number of users to capture functional requirements and high-level designs of complex systems. The notation is also being proposed as an ITU-T standard as part of the User Requirements Notation (URN) [2][19][20].

A UCM model can be constructed based on informal requirements or use cases. It describes scenarios by using *paths* that causally link *responsibilities*, which can be bound to *components*. UCM scenarios can be used to bridge the gap between requirements and detailed design [6].

*Responsibility* is a generic term for many kinds of system behaviours, such as actions, operations, tasks, and functions to be performed, messages to be manipulated, and

so on. Causal relationships between responsibilities may be in sequence, alternatives, or in parallel.

*Components* are the entities composing the system. They can be software entities such as objects, processes, databases, and servers as well as non-software entities such as hardware or actors. Components can be hosted by *devices*, which represent computing units such as processors.

When paths become too complex to fit in one single UCM diagram, they can be refined by adding another construct, called a *stub*. Stubs may contain separate sub-maps called *plug-ins*, and the latter can be reused in many stubs. There are two kinds of stubs:

- *Static stubs*: represented as plain diamonds, they contain only one plug-in.
- *Dynamic stubs*: represented as dashed diamonds, they can contain several plug-ins, whose selection is determined at run-time according to a selection policy.

Consequently, a UCM can be hierarchical. The top-level UCM is called the *root* map. The *root* map can include some containers (*stubs*) for sub-maps (*plug-ins*). *Stubs* can be contained in *plug-ins*.

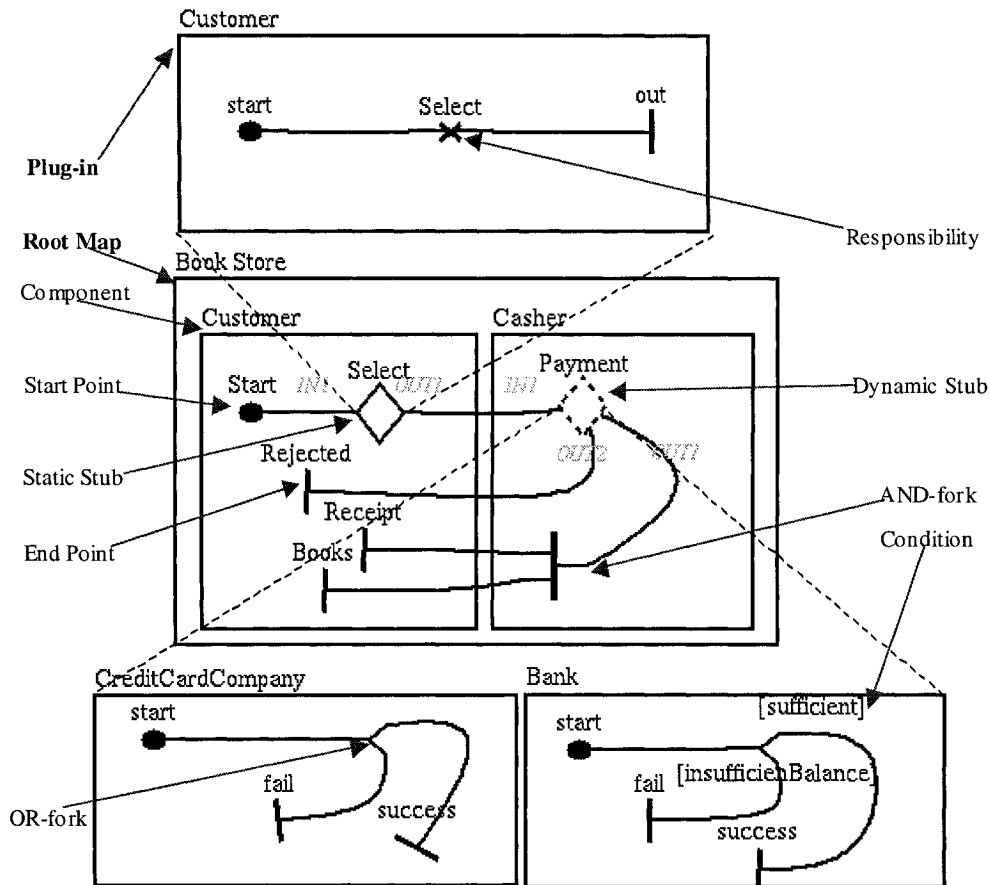

**Figure 2** A simple UCM

Figure 2 illustrates most of the UCM concepts and notation elements to be expressed in the RMS. Further information related to these concepts will be provided in Chapter 3.

UCMs have been found to be useful in describing and validating a wide range of systems, including Wireless Intelligent Networks [3][40], Wireless ATM [10], GPRS [8], agent systems [14], and Web applications [9]. They have been used in other types of applications such as program comprehension [15] and business process modelling [38][39].

UCM describes requirements of systems in views of scenarios. How to keep UCMs traceable to and consistent with other requirements is a question addressed in the approach described in thesis. Section 2.2 will introduce a generic system managing various kinds of requirements.

### 2.1.3 UCMNAV

UCMNAV [24] is a graphical tool for the edition and exploration of Use Case Map models (see Figure 3). The latest released version is UCMNAV 2.2.

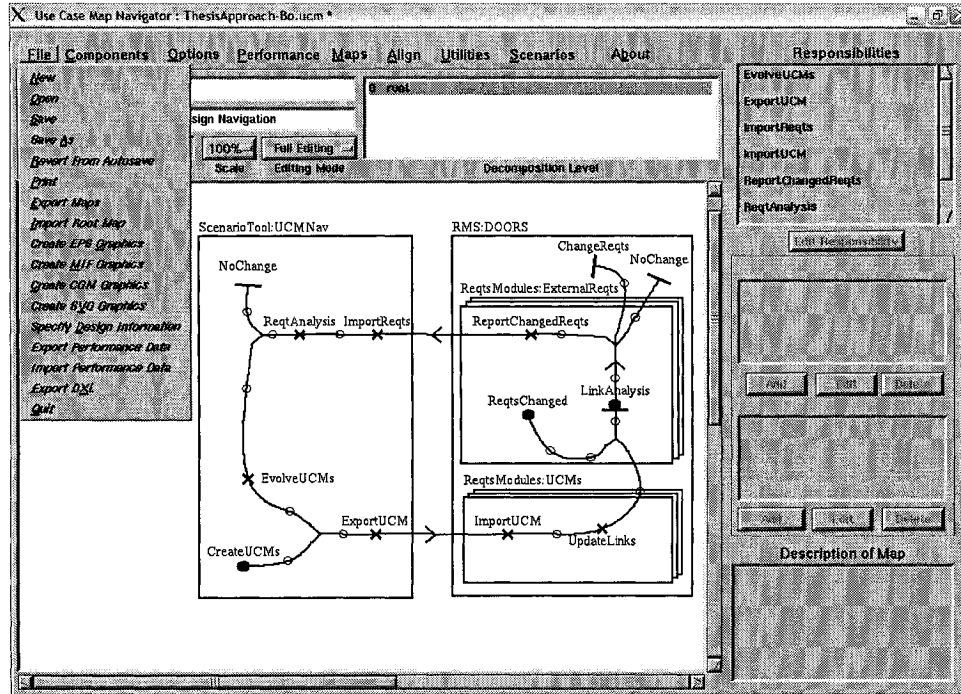

Figure 3 UCMNAV, the Use Case Map Navigator tool

UCMNAV provides the following functionalities:

- Create, navigate and edit UCMs.
- Load and save UCMs in XML format
- Export UCM diagrams in format of EPS, MIF, CGM, and SVG.
- Define and traverse scenarios and export scenarios in XML format.
- Export Message Sequence Charts (MSC) from UCMs.

As UCM are applied to more and more application domains in collaboration with other notations, some tools have been developed to convert UCMs to other representations. For instance, Petriu developed a UCM2LQN exporter that converts annotated UCM design models into Layered Queueing Network (LQN) performance models [27]. Echihabi developed UCMEXPORTER, a tool that converts UCM scenarios to Message Sequence Charts and to UML sequence diagrams in XMI [5]. Recently, Zeng extended UCMNAV to export UCM models to the Core Scenario Model representation [41]. The current the-

sis implements an export mechanism for UCMNAV to transform UCM models into DXL scripts [33], which can be recognized by a requirements management system (Telelogic DOORS) [32].

## 2.2. Requirements Management Systems

### 2.2.1 General Characteristics

Requirements Management Systems (RMS) are collaborative applications for requirements capture, management, and analysis. They enable users to capture, link, trace, analyze, and manage changes to information to ensure a project's compliance to specified requirements and standards. In general, RMSs support the following functionalities [30]:

- *Traceability and Impact Analysis:* This includes the creation of logical links between requirements and often their view in a global matrix. Users usually can view the impact of any proposed change before it is made. Impacts are relayed immediately to stakeholders so they may be proactively taken care of at that stage rather than be discovered at a later stage in the lifecycle when it is far more expensive to address.
- *Requirements Change Management:* Because requirements are the basis for everything else in a project, managing change to those requirements is critical. All informal changes should be recorded in a history and other data impacted by those changes should be emphasized so that all stakeholders know that data might be “suspect”.
- *Baseline and Release Management:* Requirements can be frozen at some point in time, and then a baseline is created. Incremental changes are then defined against this baseline. Several branches can often be supported as well.
- *Security:* RMSs often provide users management with access control.

### 2.2.2 Telelogic DOORS

DOORS, a widely used requirements management system, manages text objects, diagrams, or documents under revision control, and supports links between objects [32]. It uses a client-server architecture where the requirements database can be accessed re-

motely by a number of clients. DOORS satisfies the functionalities requirements for RMS candidates very well, therefore it is selected as the RMS to be used in collaboration with UCM scenarios in the approach described in this thesis.

### **DOORS structure**

Several important DOORS concepts need to be introduced at this point:

- *DOORS Database*: DOORS can connect to one database at a time. All of the data goes into the DOORS database including *folders*, *projects*, and *modules*, as shown in Figure 4.
- *Folder*: Folders are used to structure the data available within the DOORS database. They may contain other *folders*, *projects*, and *modules*.
- *Project*: A project is a “work area” for a team. Projects are used by a team to manage a collection of data related to the team’s work effort. They may contain *folders*, *sub-projects*, and *modules*.

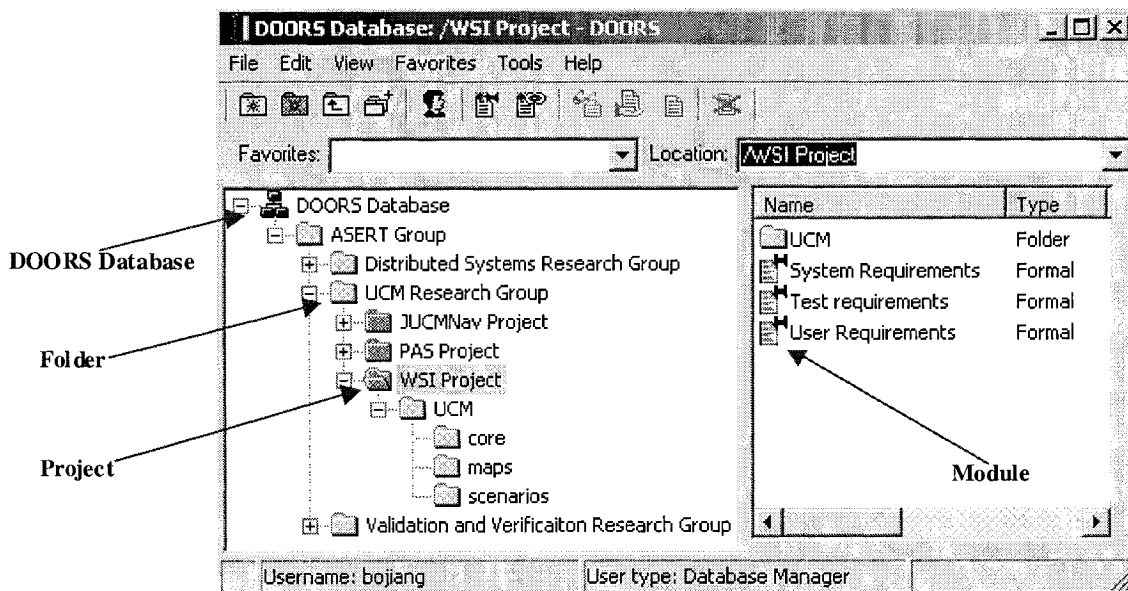

**Figure 4** DOORS database view

### **Requirements in DOORS**

- *Formal module*: A formal module is a container for information (requirements, graphics, etc). It is typically structured and displayed as a document. However, it may also be structured and displayed as a data file, which is how a UCM model

will be represented in DOORS. A formal module is a collection of *objects*, as shown in Figure 5. In this thesis, formal modules are often simply called *modules*.

- *Object*: Within formal modules, data are stored as objects. Objects may be used for requirement text, headings, graphics or other information. An object may contain other objects (e.g., under a given heading).
- *Attributes*: Attributes are additional characteristics of an *object*. Users may define additional attributes to store their own data about objects, which is how properties of UCM objects will be stored in DOORS.

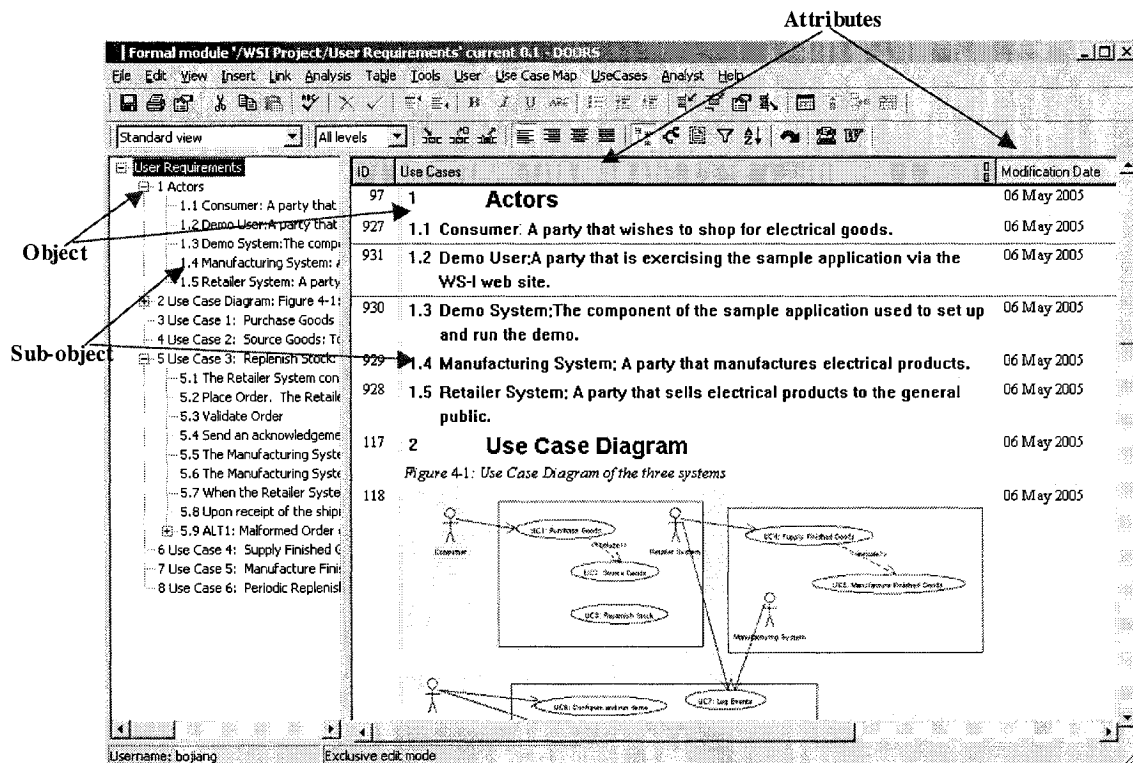

Figure 5 View of formal module

### Traceability in DOORS

- *Links*: A link is a typed relationship between two objects in the DOORS database. It connects a *source object* to a *target object*. *Link modules* contain the instances of links that share the same type. If a source or target object is modified after the corresponding link is created or “cleared of suspicion”, the link is triggered as a *suspect link*. Suspect links indicate a change in one of the connected requirements

objects. Suspect links can be cleared manually after inspection. Further details about suspect links and their use are provided in section 5.1.

### 2.2.3 DXL

As described in [33], DXL (DOORS eXtension Language) is a scripting language specially developed for DOORS. DXL is used in many parts of DOORS to provide key features, such as file format importers and exporters, impact and traceability analysis, and inter-module linking tools. DXL can also be used to develop larger add-on packages such as CASE tool interfaces and project management tools. To the end user, DXL-developed applications appear as seamless extensions to the graphical user interface. This capability to extend or customize DOORS is available to users who choose to develop their own DXL scripts. DXL takes many of its fundamental features from C and C++. In the approach described in this thesis, DXL is used to define an Application Programming Interface (API) for importing Use Case Map models into DOORS.

```
//function
void createObject(Module currentModule, string ID, string Name, string theDescription)
{
    Object currentObject=create currentModule
    currentObject."ID"=ID
    currentObject."Name"=Name
    currentObject."theDescription"=theDescription
}

// Main program
Module currentModule=create("TestModule", "This is a test.", "0", 1)
create object type "String" (default "") attribute "ID"
create object type "String" (default "") attribute "Name"
create object type "String" (default "") attribute "theDescription"

createObject(currentModule, "1", "Object1", "The first testing object")
createObject(currentModule, "2", "Object2", "The second testing object")
createObject(currentModule, "3", "Object3", "The third testing object")
```

**Figure 6** Sample of DXL code

In the sample DXL code in Figure 6, a void function is defined (*createObject*), together with its typed parameters. DXL provides types for declaring and using basic DOORS concepts such as objects and modules. The dot operator (.) is used to access or modify an attribute of an object. Function invocations are also possible. The simple example in Figure 6 shows how DXL handle modules and objects and how functions are called. A *TestModule* is first created, and then three attributes of type String are defined for all ob-

jects in this module. The function *createObject* is called three times to create and add three objects (with their attributes) to *TestModule*.

In our approach, DXL scripts are generated by UCMNAV to export Use Case Map models. DXL scripts invoke the functions of the DXL API we defined for our project. DXL scripts can be run within DOORS to create UCM objects and links and hence “import” the UCM model in the requirements database.

## **2.3. Scenarios and RMS**

This thesis describes an approach that combines UCM scenarios with the DOORS RMS. UCMs are imported into DOORS and then connected to external requirements with links. These links can be exploited for evolving scenarios, requirements, and designs. There exist other tools that combine scenario notations with a RMS, and the ones closest to our approach are two plug-in tools for DOORS called *Scenario Plus* and *DOORS/Analyst*. Both are introduced here and will be revisited for comparison with our own tool in section 6.5.2.

### **2.3.1 Scenario Plus**

*Scenario Plus* [1] is a tool-supported, scenario-based approach developed by Ian Alexander. By introducing many kinds of scenario and related notations into DOORS (goal, use case, dataflow, object relationship, etc.), it helps generate various requirements for development projects, spanning the complete range from initial mission definition and stakeholder analysis to acceptance test definition. The creation of several types of diagrams is done directly within DOORS via DXL scripts. Figure 7 shows an example where a use case diagram is edited. The graphical views are created from and synchronized with a more conventional view where textual objects are structured (Figure 8).

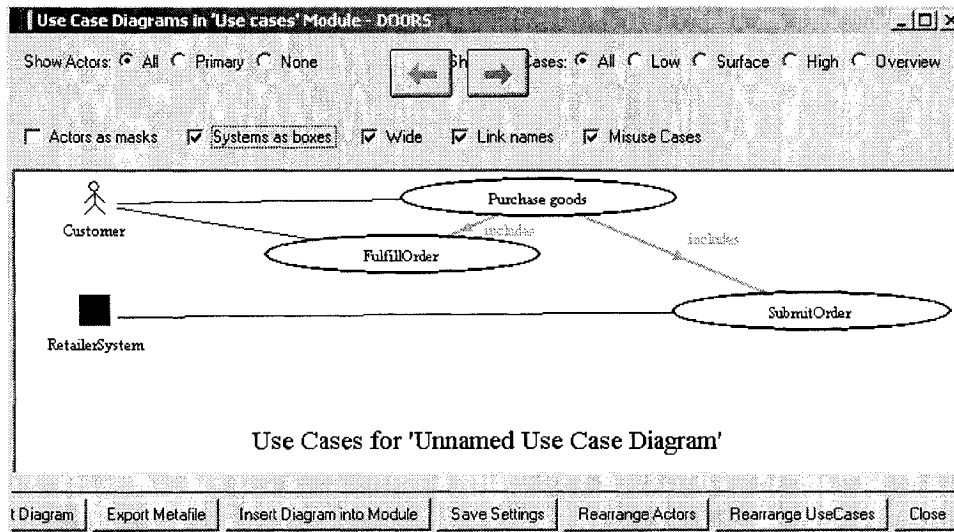

Figure 7 Scenario Plus: Use case editor

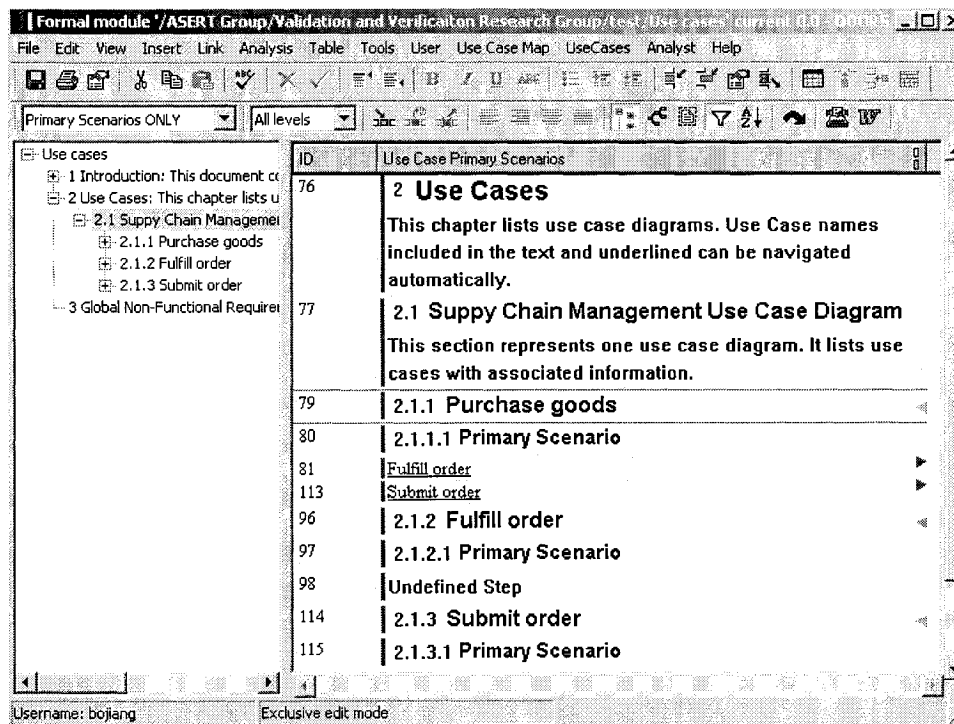

Figure 8 Scenario Plus: Use case module in DOORS

Unfortunately, Scenario Plus does not support the UCM notation. Diagrams need to be created from the DOORS interface, which is not really meant to be a graphical editor. Hence, diagram editing suffers from a lack of usability and performance. Diagrams created by more specialized external tool cannot be imported.

### 2.3.2 DOORS/Analyst

*DOORS/Analyst* [31] is a plug-in that enables DOORS to use UML diagrams inside requirements modules. As UML 2.0 is supported [26], this tool provides support for scenario-based diagrams such as *Use Case Diagrams* and *Sequence Diagrams*. Taking advantages of UML diagrams, requirements can be captured more precisely in DOORS.

UML diagrams can be embedded in any module. Double-clicking on a diagram brings up a convivial editor, which is actually the editor used in Telelogic Tau/Developer G2. Any modification to a diagram is synchronized with the DOORS database when the user leaves the editor. For example, Figure 9 shows the class diagram editor.

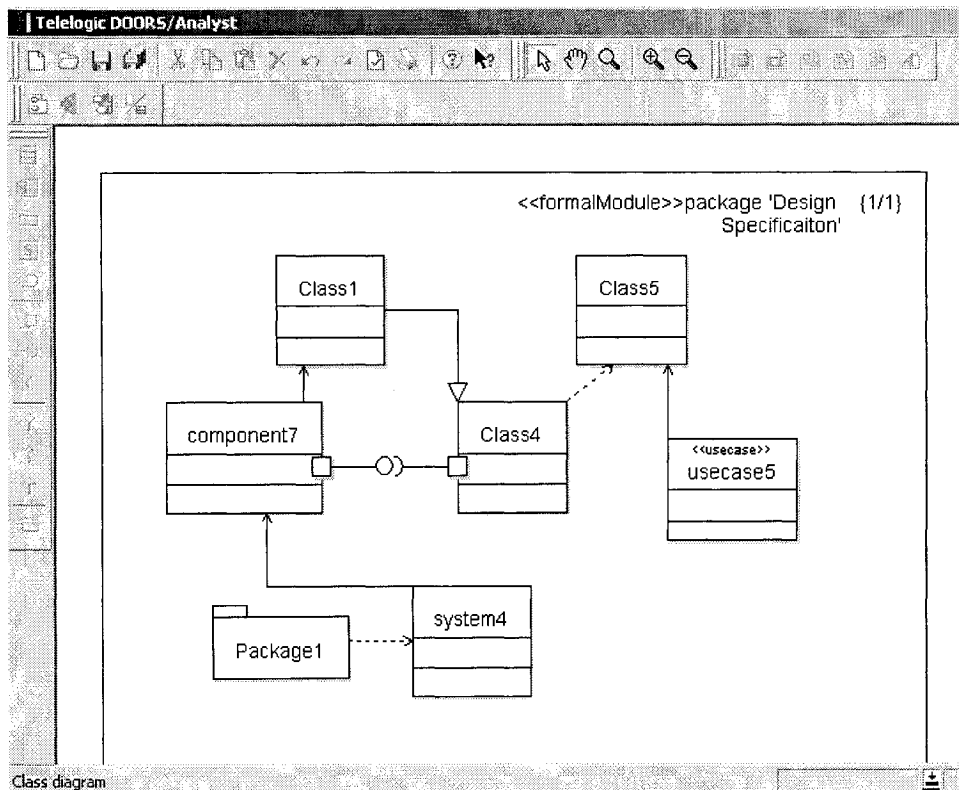

**Figure 9** DOORS/Analyst: Class diagram in editor

When leaving the editor, a bitmap version of the diagram is embedded in the module, together with objects corresponding to the main elements of the diagram (Figure 10). These objects can be linked to other requirements, hence providing traceability relationships between UML artefacts and requirements.

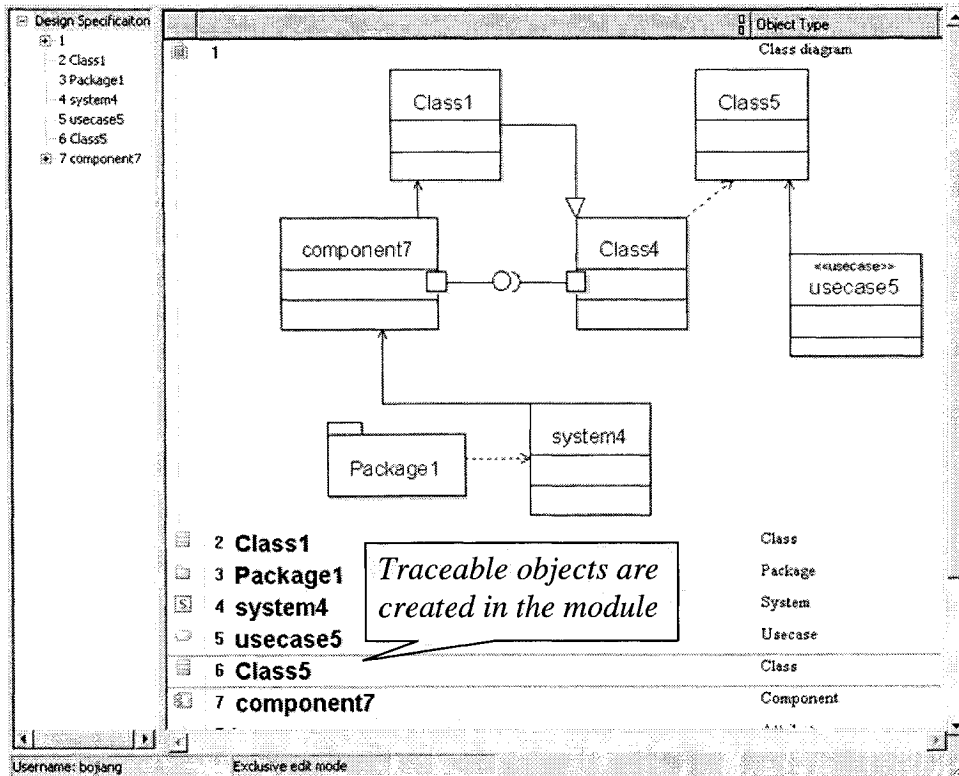

**Figure 10** DOORS/Analyst: Class diagram in formal module

However, not all UML diagram elements become DOORS objects. As shown in Figure 11, the UML 2.0 sequence diagram itself is imported back to the module, but its various elements (objects, messages, etc.) are not converted to objects and hence are not linkable.

DOORS/Analyst provides the capabilities to export these diagrams to design tools, such as Tau/Architect and Tau/Developer, which is useful when moving from requirements to the design stage. However, once these diagrams are changed in the design tool, the changes cannot be brought back to DOORS. DOORS/Analyst lacks a good update mechanism for these diagrams.

Obviously, as DOORS/Analyst focuses on UML 2.0, it does not provide support for expressing UCMs in DOORS.

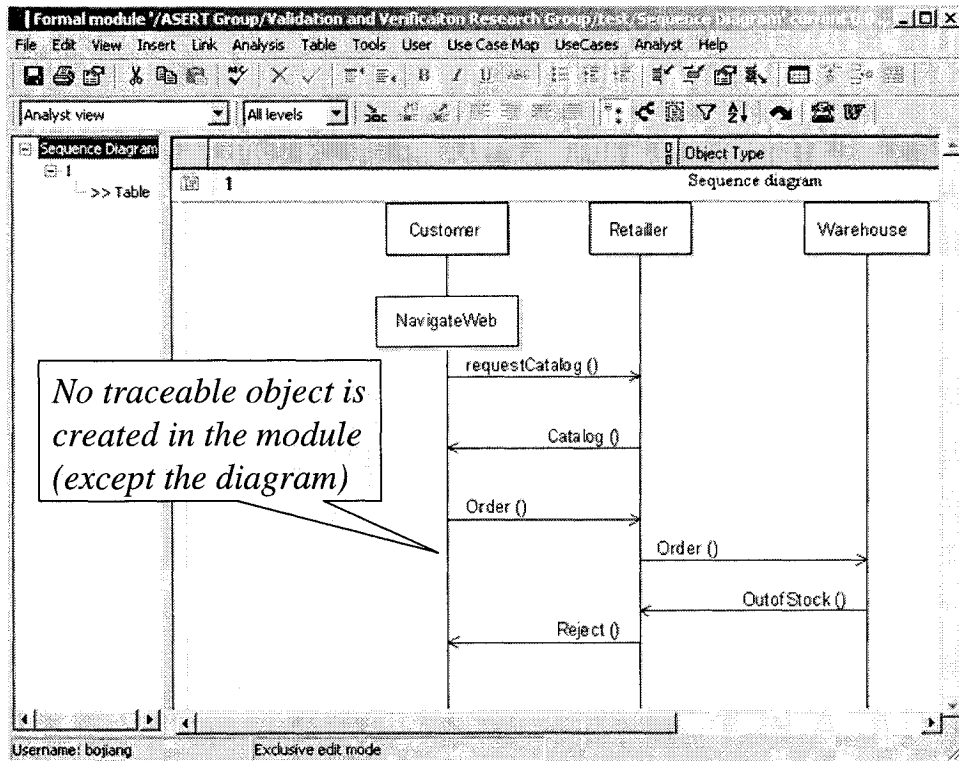

Figure 11 DOORS/Analyst: Sequence diagram in formal module

## 2.4. Chapter Summary

This chapter first introduced the scenarios notation used in this thesis, Use Case Maps, together with the UCMNAV tool (section 2.1). Then, section 2.2 presented a typical requirements management system, Telelogic DOORS, with a special emphasis on its main functionalities, structure, requirements view, and scripting language (DXL). Finally, this chapter provided an overview of two existing tools that combine scenarios with a RMS: Scenario Plus and DOORS/Analyst (section 2.3). The next chapter will explain how the essence of UCM models can be exported by UCMNAV in a format understood by DOORS.

## Chapter 3. Exporting UCM Model from UCMNAV

---

This chapter describes a metamodel that represents the essence of the Use Case Map notation. In section 3.1, a metamodel of the UCM notation is reverse-engineered from the existing UCM file format supported by UCMNAV as well as other sources. Section 3.2 then explains how UCM models are exported to the target RMS, namely Telelogic DOORS, in a format that the RMS can understand. Several exporting strategies and difficulties in the implementation are also discussed. Sections 3.3, 3.4, and 3.5 provide detailed descriptions of the elements (core, maps, and scenarios) found in the metamodel, their attributes and associations.

### 3.1. UCM Metamodel

#### 3.1.1 Understanding UCMs

Currently, there is no standard metamodel for the UCM notation. However, there exist several ways one can use to construct or recover such a metamodel. For instance, one can use the source code of the UCM tool, UCMNAV [34], or use the UCM file formats (expressed as XML 1.1 Document Type Definitions – DTD [35]) in UCMNAV and in the draft UCM standard (Z.152 [20]).

The source code of UCMNAV provides extensive information on UCMs. However, in that source code, the core UCM information is mixed with many other implementation details found in various C++ classes. Reverse-engineering a class diagram from the source code often leads to too many classes and attributes (e.g., related to layout or design patterns), and to too few relevant associations and other relationships between these classes. For example, Rational Rose [18] was used to reverse-engineer such a diagram. It was useful to understand the implementation of UCMNAV, but it was indeed too complex to extract a useful metamodel for UCMs because UCMNAV does not clearly separate the model from the visual or layout aspects.

The UCM draft standard [20] includes a specification of the UCM notation with a DTD, where the UCM concepts are defined in terms of elements and their attributes. The semantics of the language is described in natural language. This DTD proposes an XML-based interchange format for UCM tools. Implementation details are absent from this specification. This UCM DTD provides a more concise and understandable description of the nature of UCMs than the source code of UCMNAV, even if it also has limitations related to the identification of associations between classes in the target metamodel. It is also more concise than the UCMNAV DTD, which includes several obsolete UCMNAV features (such as UCM sets) irrelevant to the target metamodel.

There is also another source of useful and complementary information worth considering. UCMNAV can export scenarios resulting from the traversal of a complex UCM model according to scenario definitions. There exists another DTD describing the export format, also in XML (not part of the Z.152 draft standard) [7]. Since these scenarios are also relevant to the description of UCM models and since they can be exploited by RMS tools (e.g., by linking them to test cases), we will combine this information to the one from the UCM DTD.

### **3.1.2 Creating the UCM Metamodel**

Using the Z.152 and the UCM scenario DTDs as a start point, reverse-engineering tools can be used to help the automatic generation of the class diagram describing the current UCM metamodel. Rational Rose, which supports the reverse-engineering of models from a DTD, was used in this thesis. This led to a flat class diagram, which was refactored manually into several packages where the classes were sorted according to their purpose (Figure 12). This reduced the complexity of the reverse-engineered class diagram. Several class attributes were also transformed to more meaningful associations in the metamodel, associations that were not reverse-engineered properly by Rational Rose.

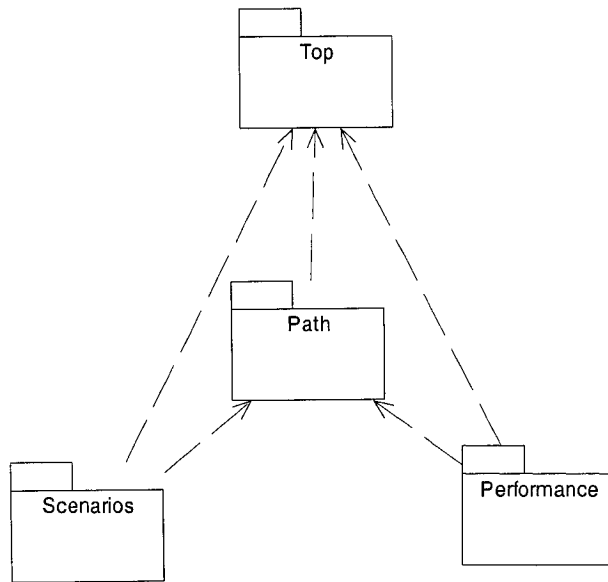

**Figure 12** Overview of the UCM metamodel based the Z.152 and scenario DTDs.

The *Top* package contains the top-level class, *UCM-design*, and its sub-elements. The *Path* package defines the UCM path notation used for the definition of causal scenarios. In particular, it includes the “map” concept, expressed as `model` in the class diagram, and its compositions. The *Performance* package contains the elements related to UCM performance annotations. The *Scenarios* package defines the elements for UCM scenario definitions in UCM, reverse-engineered from the DTD found in [7]. These packages are presented in detail below.

***Top package***

A `uclm-design` is composed of a collection of `boolean-variables`, a top level `root-map` and, possibly, of a collection of `plug-in-maps`, with their bindings (Figure 13). Both root maps and plug-in maps are kinds of `models`. There are also collections of `component` and `responsibility` definitions in a UCM design. These definitions will be referenced by paths in maps. Finally, `plugin-bindings` describe the input/output connections linking a stub in a parent map to the start and end points in a submap.

**Figure 13** Top package of UCM metamodel

## Path package

In this package, the path specification of a UCM model is described as a hypergraph that represents the causal scenarios. A hypergraph is a graph structure specifying all the elements, called hyperedges, which make up the paths (Figure 14). The different types of hyperedges include start and end-points, waiting-places, responsibility references, OR-forks and OR-joins (classes fork and join), AND-joins and AND-forks (called synchronizations), loops, aborts, stubs, performance time-stamp-points, and connections (connect) for various asynchronous and synchronous interactions between paths.

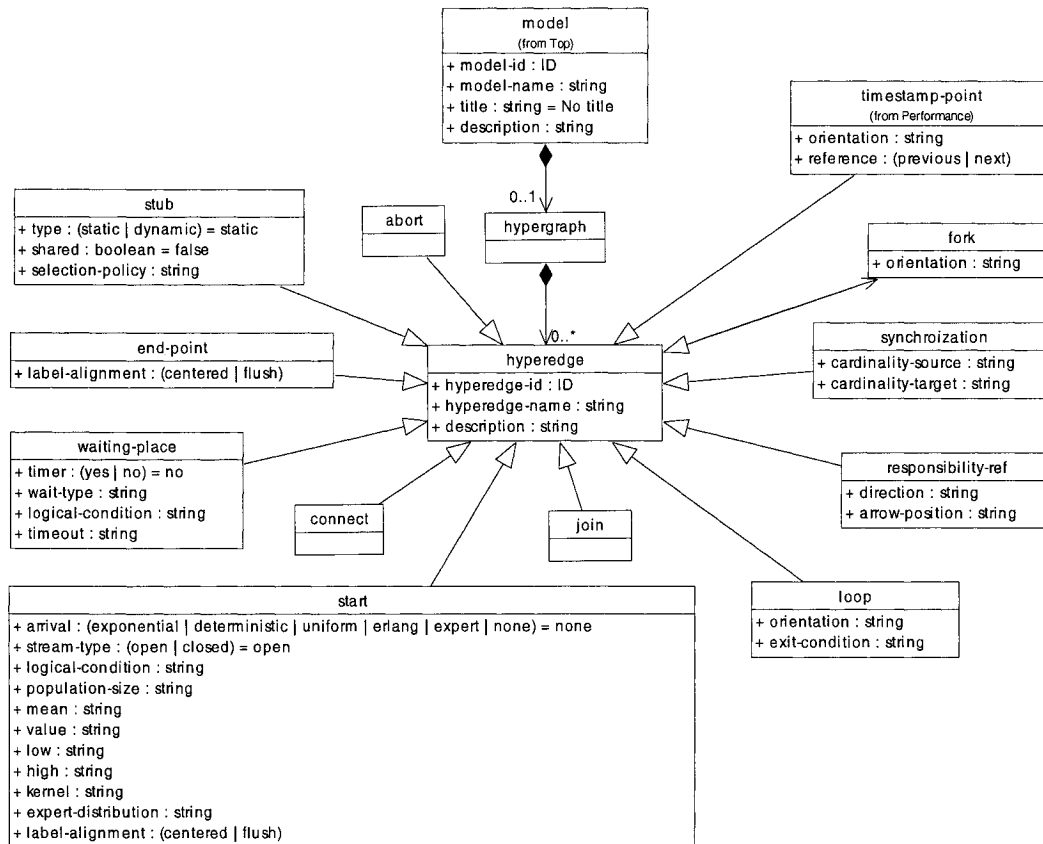

Figure 14 Path package of UCM metamodel (1)

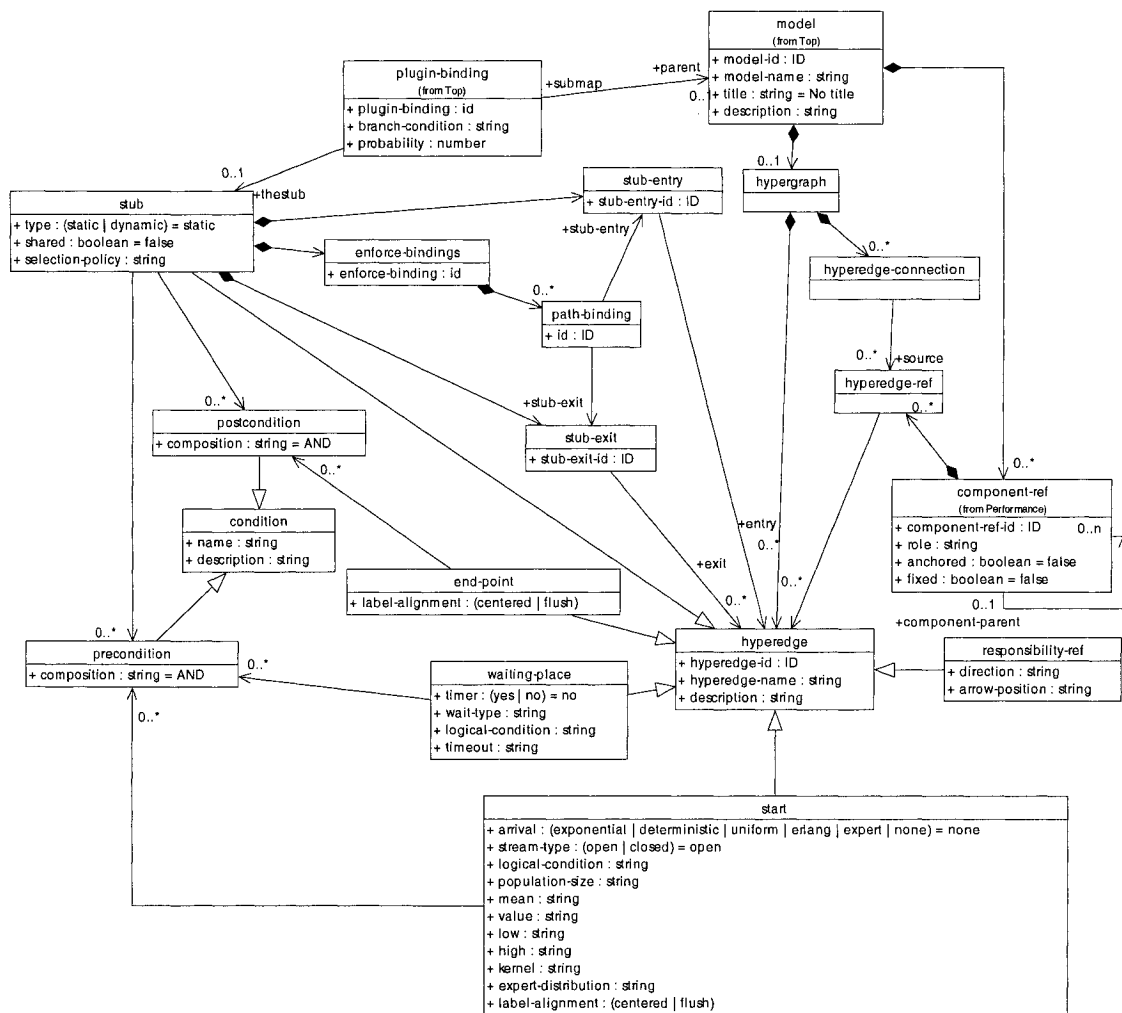

Figure 15 Path package of UCM metamodel (2)

As seen in Figure 15, a hypergraph also includes links between hyperedges, which are called hyperedge-connections. Different preconditions and postconditions can be associated with various path elements. Additionally, stubs may contain constraints on the plug-in maps (i.e., the sub-maps) that can be bound (enforced-bindings).

### Scenario package

The scenario-definition element in the Top package defines a scenario by specifying the start points and initial values for the Boolean variables used in the model. The UCMNAV tool uses these definitions to highlight and export particular scenario traces. However, to transform UCM scenarios to other scenario languages, a standalone scenario representation is used as an intermediate representation. The class diagram in Figure 16

describes the syntax of that representation. A scenario is a partial order that can use of sequence (`seq`) and parallel (`par`) operators recursively. The `do` element, which can be of various types, describes each UCM element visited together with the component to which it is allocated. The `condition` element captures the conditions satisfied during the traversal of the UCMs (e.g., at choice points and in dynamic stubs). Scenarios can also be grouped.

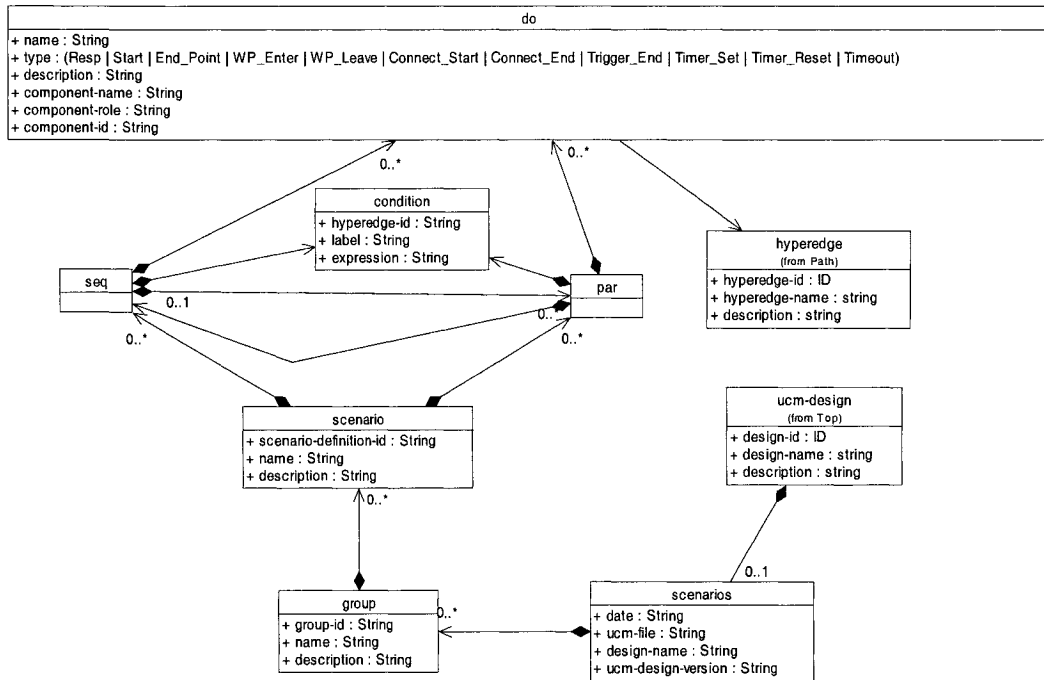
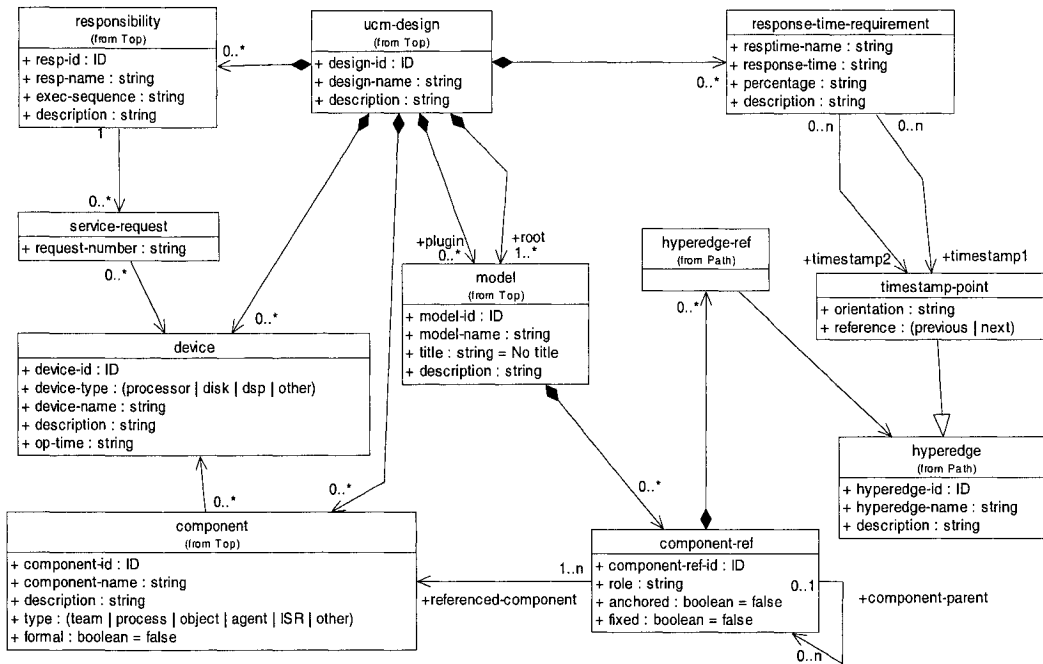

Figure 16 Scenario package of UCM metamodel

### Performance package

In Use Case Maps, performance annotations (Figure 17) are composed of `response-time-requirements` which contain references to two `timestamp-points` (starting and ending timestamp points). Devices are a necessary part of the execution environment of the performance models expressed in UCM. A `device` could be a processor, a disk, a DSP (digital signal processing unit), or other. A device may also have a predefined speed factor.



**Figure 17** Performance package of UCM metamodel

The class diagrams discussed in this section do not exhaustively cover all the elements in UCM. However, they are useful to UCM understanding, modifications, and future extensions.

### 3.1.3 Principles for Exporting UCM Models

Most requirements management systems focus on structured textual requirements, with support for traceability, access control, and version control. Structured textual requirements suffer from many limitations when expressing scenario information such as synchronizations and interactions.

The Use Case Map notation, a scenario-oriented notation, describes multiple scenarios in a single, integrated view. This promotes the understanding and reasoning about the system as a whole, as well as the early detection of conflicting or inconsistent scenarios. [7]

In this thesis, a subset of the UCM model is selected and transmitted to the RMS. This subset focuses mainly on scenario elements that are potentially useful to establish and exploit links to/from other types of requirements. There is no technical reason pre-

venting one from exporting all the elements found in a UCM model, however this would take more space in the RMS database and reduce the overall performance of the approach for no obvious benefit.

To select the subset of UCM to be exported to the RMS, the following principles are considered, in accordance with the objectives of the thesis.

1. *Essential concepts of UCMs should be covered:* As we want to establish and exploit links between scenarios and other types of requirements, basic behaviour elements (responsibilities), basic structure elements (components), as well as their references in maps and their containment relationships must be preserved.
2. *Traceability across maps should be preserved:* As we want to explore transitive relationships between external elements and various UCM elements that could be in different maps (e.g., for impact assessment), essential information related to stub/plugin relationships need to be exported.
3. *Essential performance concepts should be included:* As we want to enable analysis between external requirements and scenarios from a performance perspective, connections between elements and their respective devices must be exported.
4. *Important scenarios should be preserved:* As we want to explore transitive relationships between requirements and link UCM models to test cases, scenarios resulting from the traversal of UCM models according to scenario definitions should be included. This does not imply that we need to replicate the original hypergraph structure with forks and joins (as this would cover all the scenarios, many of which being uninteresting).
5. *A minimal number of UCM elements should be exported:* This is to prevent performance degradation in the RMS database.

Taking these principles into consideration, the class diagram in Figure 18 shows the selected subset of the UCM metamodel which will be exported to the RMS tool. Component, responsibility and their references are selected because they are the basic elements in UCM and have tight relationships with requirements. Components describe the entities or objects composing the system and responsibilities represent actions, tasks, or functions to be performed in the system. All concepts in scenarios are selected because the UCM

scenario acts as an important role in expressing the functional requirements. Device is selected because it is the core concept for performance modeling in UCM. The traceability between the selected UCM elements for the DOORS database (shown in Figure 18) and the UCM metamodel (shown in Figure 13 to Figure 17) is specified in —Table 1. Note that the elements from the UCM metamodel that are not included in this table are not transferred to DOORS according to principle 5 (minimality). The detailed information about the selected UCM model is discussed in sections 3.3, 3.4, and 3.5.

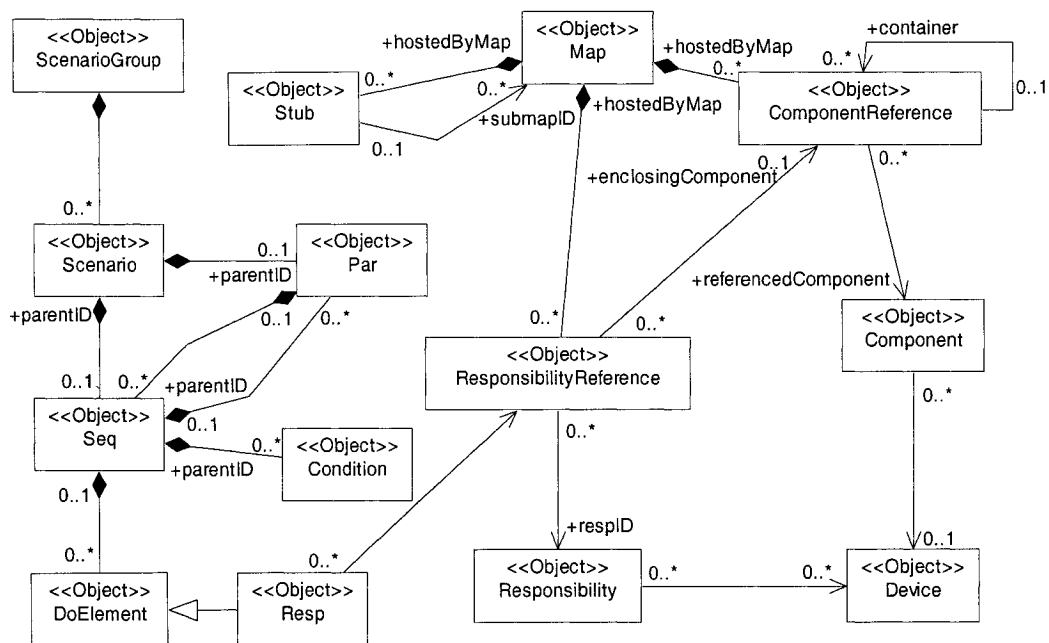

**Figure 18** Metamodel of exported UCM models

Package	UCM Metamodel Class	Exported Metamodel Class (Figure 18)	Justification (principles)
Path (Figure 14)	model	Map	1,2
Path (Figure 15)	stub	Stub	2
Path (Figure 14)	responsibility-ref	ResponsibilityReference	1
Performance (Figure 17)	component-ref	ComponenReference	1
Top (Figure 13)	component	Component	1
Top (Figure 13)	responsibility	Responsibility	1
Top (Figure 13)	device	Device	3
Scenario (Figure 16)	group	ScenarioGroup	4
Scenario (Figure 16)	scenario	Scenario	4
Scenario (Figure 16)	seq	Seq	4
Scenario (Figure 16)	par	Par	4
Scenario (Figure 16)	do	DoElement	4
Scenario (Figure 16)	condition	Condition	4

**Table 1** Traceability between the UCM metamodel and the exported subset

### 3.2. Exporting Strategies

The potential exporting process should enable the creation of a new UCM model in the RMS when it is imported for the first time. Evolving UCM models would be updated in the RMS simply by reimporting them. Links should be created and updated automatically to capture the relations between UCM objects. Attributes of the requirement module should be used to store properties information of UCM objects.

Telelogic DOORS can accept many file formats as input in order to create requirements modules, including Word, Rich Text Format, plain text, Interleaf, and FrameMaker. However, such importing mechanisms have some limitations. Firstly, DOORS can only create a new requirements model for the imported information and cannot recognize and updated version of the source document (to the requirements module cannot be updated accordingly). Secondly, DOORS cannot create links between the imported objects. Last, DOORS cannot create attributes for the imported objects. These formats hence are not good candidates for the importing and updating of UCM scenario information in the DOORS repository.

We could import the XML files generated by UCMNAV into DOORS. However, some information about the UCM model is not expressed in the XML file directly and requires further analysis. For instance, figures of maps are not provided in the XML file generated from UCMNAV. They can only be obtained by redrawing all items specified in the XML file. Scenarios with concrete steps are also missing; only scenario definitions are specified. Concrete scenarios steps can only be constructed by applying a complex scenario traversal mechanism.

Another possibility is having UCMNAV export UCMs in another, more suitable, XML format capturing the elements, attributes, and associations identified in Figure 18. This could lead to a file format independent of DOORS and reusable by other tools (such as Requisite Pro). However, XML files cannot be read by DOORS directly, and a DOORS XML parser or a converter from XML to a format understandable by DOORS would need to be created.

A better strategy would be to express UCM models as DXL (DOORS eXtension Language) scripts, which can be read and run by DOORS directly. DXL is a scripting language specially developed for DOORS. It provides some key features, such as file format importers and exporters, impact and traceability analysis and inter-module linking tools. Hence, from a DOORS perspective, DXL scripts become a simple format for handling UCM models. However, there are several ways of generating DXL scripts, some of which are explored in the following sub-sections.

### **3.2.1 Generating DXL Scripts Directly From UCMNav**

In this strategy, a *DXL library* is predefined and used to run DXL scripts exported from UCMNAV and imported in DOORS (Figure 19). In the DXL library, each class in the selected subset of UCM model has a corresponding DXL function whose parameters store the information of the class attributes and its associations to other classes. UCMNAV can be enhanced to have the ability to export DXL script files compliant to the selected subset of UCM model which is proposed in section 3.1.3.

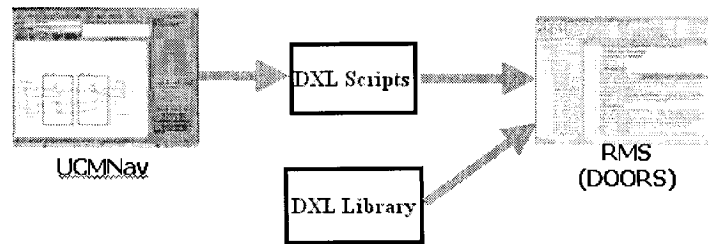

**Figure 19** Generating and importing DXL scripts

For each object in the selected subset of UCM model, the new UCMNAV will export one DXL script composed of a sequence of DXL function invocations containing a function name (corresponding to a class name in Figure 18) together with parameters specifying attribute data and associations with other objects. Figure 20 shows an example of a function called from the DXL library as generated by UCMNAV. Details about the function call are explained in section 4.2.2.

```
respRef("h12" ,230 ,344 , "m0", "cr1", "r7", "fwd_sig", "Forwards any signal received", "UP")
```

**Figure 20** DXL script example

### 3.2.2 Alternative Strategies

One alternative strategy is to use XML as the interchange format for the UCM model (see Figure 21). UCMNAV could generate a XML corresponding to the UCM model. An independent XML to DXL converter could be implemented and used to handle the XML file generated by UCMNAV. The converter could take advantages of XSLT processors to parse and convert the XML file, given an XSLT definition of the transformation. A variant strategy would be to have a converter which is not based on XSLT (and that could be integrated to UCMNAV).

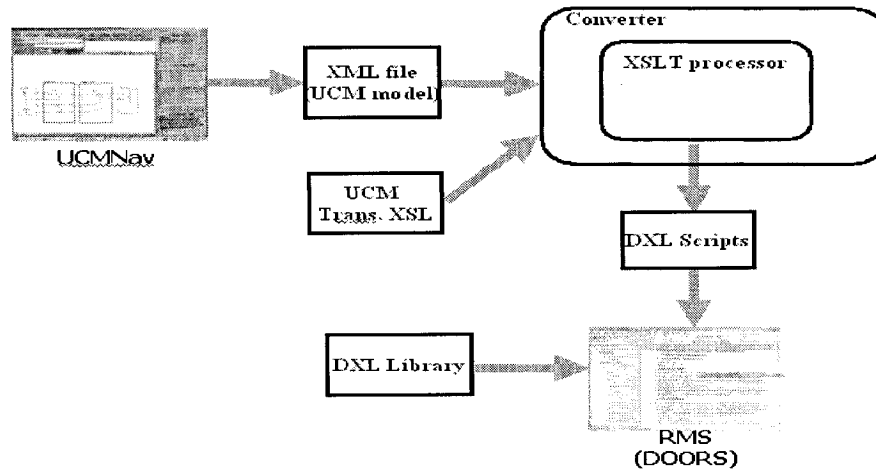

**Figure 21** Generating DXL scripts via XML

There is another variation to the above strategies where DOORS would parse XML files and generate the UCM model internally. In this strategy, the DXL library needs to be supplemented with an XML parser, which is used to extract the model information out of the XML file. However, implementing such a XML parser in DXL would require much effort and, since DXL is an interpreted language, this would slow the import process.

All these strategies require invocations to the DXL library to be present in a script. Having an XML representation of the UCM model in between would promote some independence from a specific RMS tool, but it would also require the presence of another tool (e.g., Xerces) to convert the XML files to DXL. In this thesis, since we are targeting only one RMS candidate (Telelogic DOORS), there is not much value in using XML as an intermediate format. Therefore, the first strategy is adopted in this thesis to keep the import process simple and easily implementable. Figure 3 shows the new “File -> Export DXL” menu item we have added to UCMNav to trigger this export. This could be modified at a later time to support other RMS tools, if required.

The following three sections will refine and detail the elements, attributes, and associations of the metamodel found in Figure 18. Section 3.3 presents the core elements, section 3.4 focuses on the individual maps, whereas section 3.5 presents the scenarios.

### 3.3. Core Elements and Their Associations

Core elements discussed in this section are not included in any map or scenario directly. However, these definitions are fundamental elements of a UCM model. Responsibilities show system behaviors referenced by scenarios and by maps. Components describe the structural entities of a UCM model. Devices are used to express performance-related deployment in the UCM model.

#### 3.3.1 Metamodel

The metamodel in Figure 22 details some of the classes from Figure 18. Some of the attributes found in the corresponding classes in Figure 13 have been removed while others are added to meet the needs of creating UCM maps in DOORS. Note that the «Object» stereotype used in the following diagrams indicates that instances of these classes will correspond to DOORS objects.



Figure 22 Core elements metamodel of exported UCM

#### 3.3.2 Class Specification

##### ***Responsibility***

##### ***Description***

Responsibilities are processing tasks (e.g., procedures, functions, actions, etc.) that are referenced by scenarios and by maps.

### **Attributes**

ID: String	The identifier of the responsibility.
name: String	The name of the responsibility.
processorDemand: String	Quantifies the demand on the processor associated with the responsibility. Used for performance analysis.
theDescription: String	Description of the responsibility.

### **Associations**

device: device [0..*]	A responsibility may request many devices.
-----------------------	--

## **Component**

### **Description**

Components represent, at the requirements level, abstract entities corresponding to actors, processes, objects, containers, agents, and so on.

### **Attributes**

ID: String	The identifier of the component.
name: String	The name of the component.
type: String	The type of component (Team, Object, Process, Agent, ...).
theDescription: String	Description of the component.

### **Associations**

device: device [0..1]	A component is hosted by zero or one device.
-----------------------	--

## **Device**

### **Description**

A device can be a processor, a disk, a DSP or anything else (other). A device may also have a predefined speed factor (corresponding to *op-time* in a UCM device).

### **Attributes**

ID: String	The identifier of the device.
name: String	The name of the device.
theDescription: String	Description of the device.
speedFactor: String	Speed factor (operation time) of the device.

### 3.3.3 Sample of DXL Scripts on UCM Core Model

```
BeginOfCoreImport
// Devices
device( "d0", "DBase", "", "0")
device( "d1", "Disk", "", "0")
// Map "CND"
responsibility( "r6", "display", "Displays the originator's number.", "0")
// Map "OCS"
responsibility( "r2", "checkOCS", "Checks whether the terminator is in the
  originator's OCS list. chkOCS takes the value F", "0")
responsibility( "r5", "deny", "Denies the connection. ", "0")
// Map "Originating"
responsibility( "r10", "snd-req", "Send the connection request to the terminating
  agent. ", "0")
responsibility( "r0", "InitFeatures", "Initialises the list of features to be checked
  according to their subscription information. For each feature F:
  chkF takes the value of subF", "0")
// Map "TeenLine"
component( "c1", "User", "Team", "", "")
responsibility( "r4", "checkTime", "Checks that TeenLine is active, i.e. that the
  connection is in the pre-defined time range. chkTL takes the value
  F.", "0")
responsibility( "r5", "deny", "Denies the connection. ", "0")
responsibility( "r3", "checkPIN", "Checks that the PIN is valid.", "0")
// Map "Terminating"
responsibility( "r1", "busyTreatment", "This user is busy and cannot answer. Prepare
  busy signal. ", "0")
responsibility( "r9", "ringingTreatment", "This user is available. Prepare ringback
  signal. ", "0")
responsibility( "r8", "ringTreatment", "Prepare ring signal.", "0")
// Map "root"
component( "c1", "User", "Team", "", "")
component( "c0", "Agent", "Agent", "", "")
component( "c0", "Agent", "Agent", "", "")
component( "c1", "User", "Team", "", "")
responsibility( "r7", "fwd_sig", "Forwards any signal received from terminating
  agents", "0")
responsibility( "r7", "fwd_sig", "Forwards any signal received from terminating
  agents", "0")
endOfCoreImport
```

**Figure 23** DXL script for the core elements in the Simple Telephone System

Details information about the functions used in Figure 23 are explained in section 4.2.1.

### 3.4. Maps and Their Associations

Maps define functional requirements models as causal scenarios (paths). Maps contain specifications for systems structure (component references), behavior (responsibility references), as well as stubs. Only core maps concepts are exported to DOORS as well as their relationships. The composition relationships between map with component references and responsibility references will be represented as parent-child object relationships in DOORS. More information about expressing scenario in DOORS is discussed in section 4.2.2.

#### 3.4.1 Metamodel

Some classes are omitted from the metamodel from Figure 15 in order to simplify the map model to be exported to DOORS. Some associations between classes are adjusted to describe the map model more precisely. More attributes are added to classes in the map metamodel to meet the needs of creating UCM maps in DOORS (Figure 24).

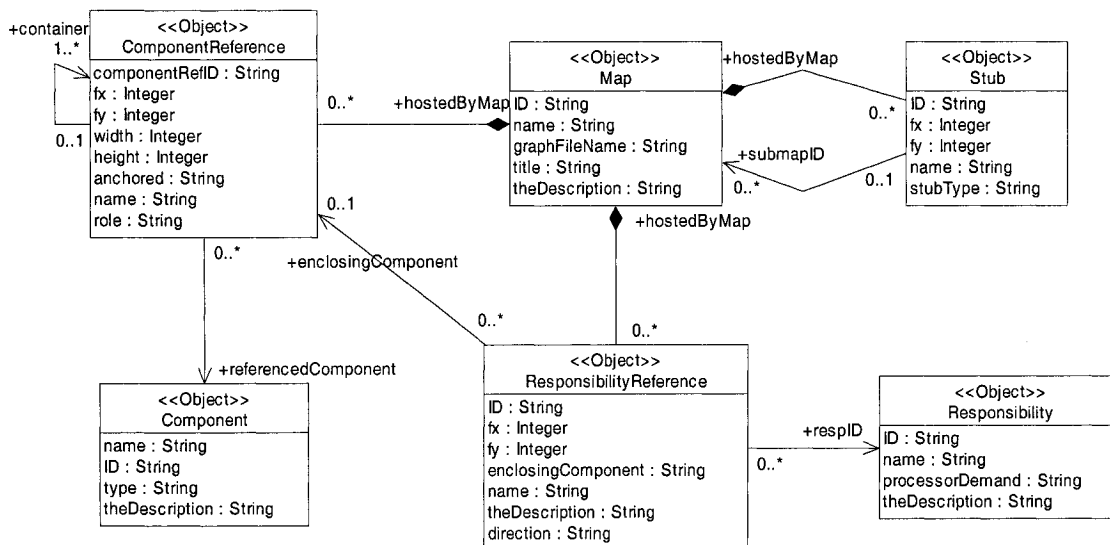

Figure 24 Map metamodel of exported UCM

### 3.4.2 Class Specifications

#### **Map**

##### **Description**

A Map is basically a collection of causal scenarios (paths). It contains specifications for systems structure (component references), behaviour (responsibility references), as well as stubs.

##### **Attributes**

ID: String	The identifier of the map.
name: String	The name of the map.
graphFileName: String	The name of the graph file exported for the map.
title: String	The title of map.
theDescription: String	Description of the map.

##### **Associations**

stub : Stub [0..*]	A map contains zero or more stubs.
compRef : ComponentReference [0..*]	A map contains zero or more ComponentReference objects.
respRef : ResponsibilityReference [0..*]	A map contains zero or more ResponsibilityReference objects.

#### **Stub**

##### **Description**

In a UCM, stubs are used as containers for plug-in maps (i.e. sub-maps). Stubs can be static or dynamic. While static stubs contain only one plug-in, dynamic stubs may contain multiple plug-ins. X-Y coordinates are generated for future use (to enable clickable UCM diagrams in DOORS).

##### **Attributes**

ID: String	The identifier of the stub.
name: String	The name of the stub.
fy: Integer	The vertical (Y) coordinate of the stub on the map.
fx: Integer	The horizontal (X) coordinate of the stub on the map.
stubType: String	The type of stub (static or dynamic).

##### **Associations**

HostedByMap: map[0..*]	A stub is contained by one map.
submapID: map[0..*]	A stub contains zero or more plug-in maps.

## **ComponentReference**

### **Description**

A component reference refers to a component defined in the core model (section 3.3.2).

A component reference has its own role and responsibility list which references valid responsibility references. Again coordinates and sizes are captured for future usage.

### **Attributes**

ID: String	The identifier of the component reference.
name: String	The name of the component reference.
fy: Integer	The vertical (Y) coordinates of the component reference on the map.
fx: Integer	The horizontal(X) coordinates of the component reference on the map.
width: Integer	The width of the component reference on the map.
height: Integer	The height of the component reference on the map.
anchored : String	Indicates whether the object is anchored or not.
role: String	The role of the component reference.

### **Associations**

hostedByMap: Map[0..*]	A component reference is contained by zero or more maps.
referencedComponent : Component	One or many component references can refer to the same Component.
container : ComponentReference[0..*]	A component reference contains zero or more component references.

## **ResponsibilityReference**

### **Description**

A responsibility reference refers to a responsibility defined in the core model (section 3.3.2).

### **Attributes**

ID: String	The identifier of the responsibility reference.
name: String	The name of the responsibility reference.
fy: Integer	The vertical (Y) coordinates of the responsibility reference on the map.
fx: Integer	The horizontal (X) coordinates of the responsibility reference on the map.
theDescription: String	Description of the responsibility reference.
direction: String	The direction of responsibility ref. on the path.

### Associations

hostedByMap: Map	A responsibility reference is contained by one map.
respID: Responsibility	One or many responsibility references can refer to the same responsibility.
enclosingComponent: ComponentReference [0..1]	A responsibility reference contains zero or more responsibility references.

### 3.4.3 Sample of DXL Script for a Map Model

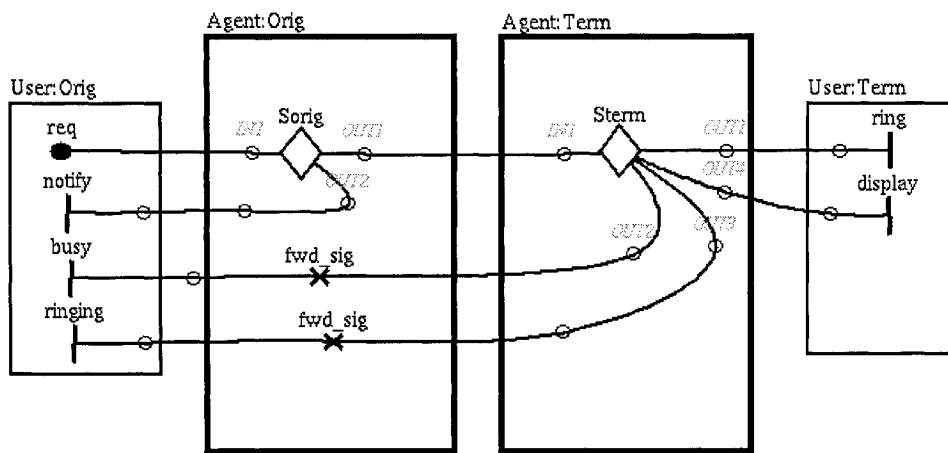

**Figure 25** Root map in the Simple Telephone System

The root map in Figure 25 gives an overview of the requirement scenarios that the Simple Telephone system supports. An originating user attempts a connection to a terminating user. Both users have their own agent, which handles their features. The DXL script in Figure 26 describes the root map information including its name, ID, graph, label and description, as well as stub references, responsibility references and component references.

```

map("m0","root","simpletelephone-sol-root.bmp","Simple Connection","Description")
  respRef("h12",230,344,"m0","cr1","r7","fwd_sig","Forwards any signal received from
    terminating agents", "UP")
  respRef("h14",239,387,"m0","cr1","r7","fwd_sig","Forwards any signal received from
    terminating agents", "UP")
  stubRef("h23",427,262,"m0","Sterm","static","m6;")
  stubRef("h24",218,263,"m0","Sorig","static","m4;")
  compRef("cr0",551,231,98,164,"no","m0","c1","User","Term","")
  compRef("cr1",156,187,162,272,"no","m0","c0","Agent","Orig","")
  compRef("cr2",350,187,163,271,"no","m0","c0","Agent","Term","")
  compRef("cr3",26,231,99,176,"no","m0","c1","User","Orig","")

```

**Figure 26** DXL script generated for the Root map in the Simple Telephone System

### 3.5. Scenarios and Their Associations

Scenario traces generated from UCMs can capture the causal relationships between responsibilities for particular scenario instances. This is useful for understanding specific situations, as well as for providing guidance for the development of validation test cases. All the scenarios concepts are exported to DOORS including their relationships. However links are not used to express the inter-relationships between scenario elements in DOORS because of the large quantity of inter-relationships in scenario. Instead, composition and sequential relationships between DOORS objects are used for describing the inter-relationships in scenario. More information about expressing scenario in DOORS is discussed in section 4.2.3.

#### 3.5.1 Metamodel

The metamodel is based on the UCM scenario DTD, version 1. Some associations between classes are adjusted to describe the scenario model more precisely. More attributes are added to classes in the scenario metamodel to meet the needs of creating UCM scenarios in DOORS.

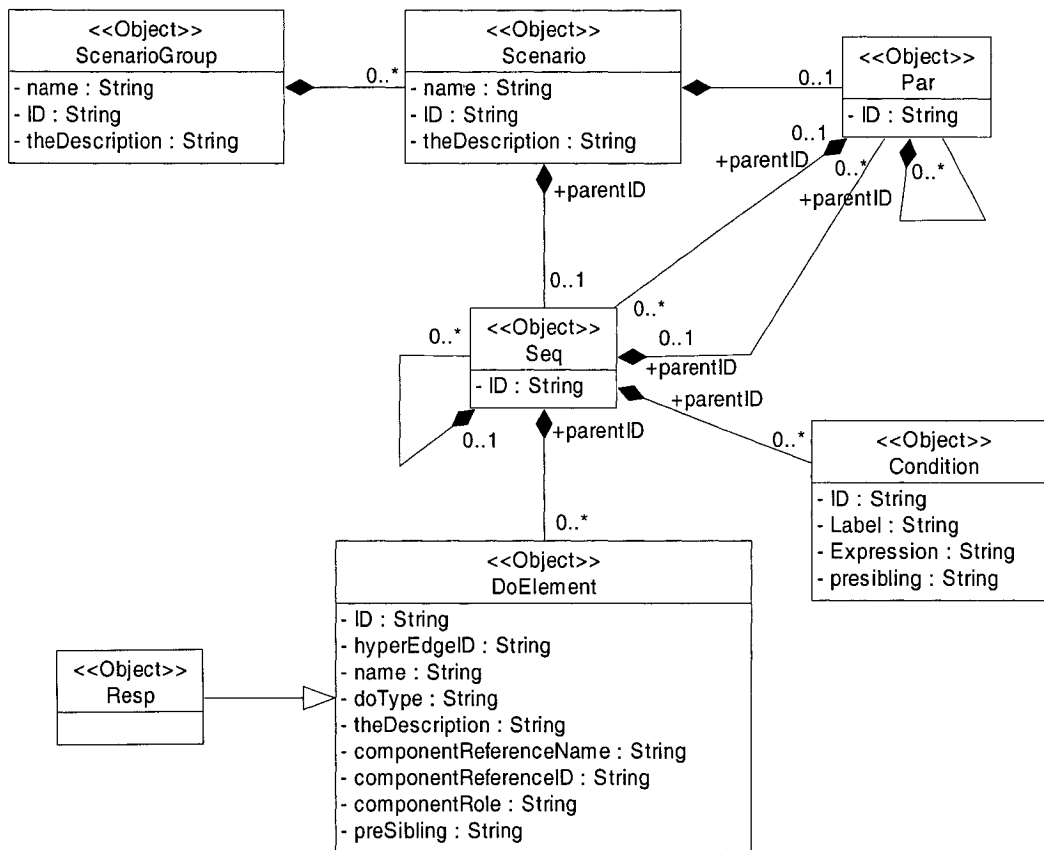

Figure 27 Scenario metamodel of exported UCM

### 3.5.2 Class Specification

#### **ScenarioGroup**

##### *Description*

Related scenarios can be put in one scenario group.

##### *Attributes*

ID: String	The identifier of the scenario group.
name: String	The name of the scenario group.
theDescription: String	Description of the scenario group.

##### *Associations*

scenario : Scenario [0..*]	A scenario group contains zero or more scenarios.
----------------------------	---

## **Scenario**

### **Description**

Scenario captures the causal relationships between responsibilities for particular scenario instances.

### **Attributes**

ID: String	The identifier of the scenario.
name: String	The name of the scenario.
theDescription: String	Description of the scenario.

### **Associations**

Par : Par [0..1]	A Scenario contains zero or one Par root object.
seq : Seq [0..1]	A Scenario contains zero or one Seq root object.

### **Constraints**

- Scenario cannot contain a root Par object and a root Seq object at the same time.

## **Par**

### **Description**

Par is a parallel operator expressing that the relationships between elements under the Par are parallel.

### **Attributes**

ID: String	The identifier of the par.
------------	----------------------------

### **Associations**

parentID: String	Parent of the current Par object.
par : Par [0..*]	Par contains zero or more Par objects.
seq : Seq [0..*]	Par contains zero or more Seq objects.

### **Notes**

In the scenario DTD for UCM, version 1, the Par can contain DoElement objects and Condition objects. Actually, this cannot happen when generating a scenario with UCMNAV. Therefore, in the scenario metamodel proposed in this thesis, Par objects cannot contain DoElement objects and Condition objects.

## **Seq**

### **Description**

Seq is a sequence operator expressing that the relationships between elements under Seq are sequential.

### *Attributes*

ID: String	The identifier of the seq.
name: String	The name of the map.
graphFileName: String	The name of the graph file exported for the map.
title: String	The title of map.
theDescription: String	Description of the map.

### *Associations*

parentID: String	Parent of the current seq.
par : Par [0..*]	A seq contains zero or more Seq objects.
seq : Seq [0..*]	A seq contains zero or more Par objects.
Conditions: Condition [0..*]	A seq contains zero or more Condition objects.
DoElements: DoElement [0..*]	A seq contains zero or more DoElement objects.

### **Condition**

#### *Description*

The condition element captures the conditions satisfied during the traversal of the UCMs (e.g. at choice points and in dynamic stubs).

#### *Attributes*

ID: String	The identifier of the condition.
label: String	Label providing an intuitive interpretation of the condition.
expression: String	Defines the Boolean expression used in the selected branch where the condition applied.
Presibling: String	Defines the Boolean expression used in the selected branch where the condition applied.

#### *Associations*

ParentID: String	Parent of the current Condition object.
------------------	---

### **DoElement**

#### *Description*

The DoElement, which can be of various types, describes each UCM element visited while traversing the UCM model.

### **Attributes**

ID: String	The identifier of the doElement.
hyperEdgeID: String	The identifier of the UCM hyperEdge referred by the current object.
doType: String	The type of element visited, which is one of the set (Resp   Start   End_Point   WP_Enter   WP_Leave   Connect_Start   Connect_End   Trigger_End   Timer_Set   Timer_Reset   Timeout).
theDescription: String	Description of the current doElement.
parentID: String	Parent of the current DoElement object.
presibling: String	Identifier of previous sibling of the current doElement.

### **Notes**

DoElement is not equal to a UCM HyperEdge. UCM Loop, Fork, Join, Synchronization, and Stub hyperedges have no DoElement equivalent.

### **Resp**

#### **Description**

A type of DoElement, expresses one visit of the responsibility reference in the map when traversing the scenario.

#### **Attributes**

#### **Associations**

responsibilityRef:ResponsibilityReference	Many Resp objects can refer to the same ResponsibilityReference object.
---	---

### 3.5.3 Sample of UCM Scenarios Scripts

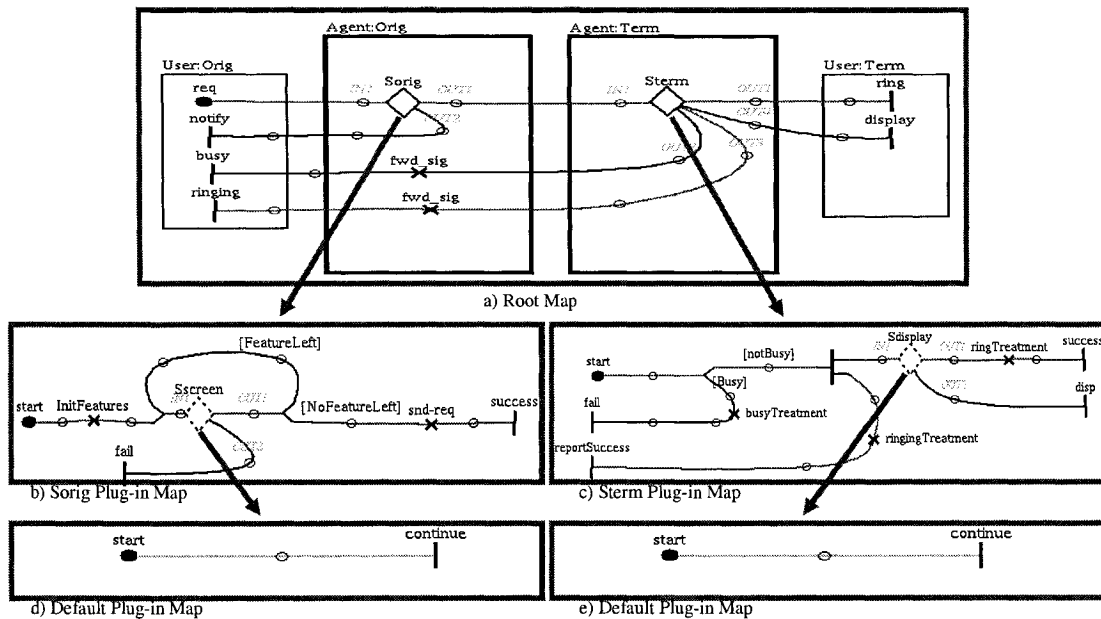

**Figure 28** Successful Basic Call Scenario in the Simple Telephone System

The highlighted paths in Figure 28 describe the successful basic call scenario in a Simple Telephone system. Upon the request of an originating user (req), the originating agent selects the appropriate user feature in stub Sorig (no feature selected in this case). Then the terminating agent selects another feature in stub Sterm (also no feature). The terminating agent sends ringing signals to both originating and terminating users. The corresponding DXL script is shown in Figure 29.

```

scenarioGroup ("BasicCall", "scenarioGroup-BasicCall", "" )
scenario( "BCsuccess", "scenarioGroup-BasicCall_scenario-BCsuccess", "")
seq("seq0", "scenarioGroup-BasicCall_scenario-BCsuccess")
doElement("h0", "", "req", "Start", "", "User", "cr3", "Orig", "seq0", "NULL")
doElement("h50", "", "start", "Connect_Start", "", "Agent", "cr1", "Orig", "seq0", "h0")
doElement("h55", "", "InitFeatures", "Resp", "", "Agent", "cr1", "Orig", "seq0", "h50")
condition("h65", "Default", "! (bv9+bv8)", "seq0", "h55")
doElement("h34", "", "start", "Connect_Start", "", "Agent", "cr1", "Orig", "seq0", "h65")
doElement("h36", "", "continue", "Connect_End", "", "Agent", "cr1", "Orig", "seq0", "h34")
condition("h57", "[NoFeatureLeft]", "! (bv9+bv8)", "seq0", "h36")
doElement("h49", "", "snd-req", "Resp", "", "Agent", "cr1", "Orig", "seq0", "h57")
doElement("h51", "", "success", "Connect_End", "", "Agent", "cr1", "Orig", "seq0", "h49")
doElement("h100", "", "start", "Connect_Start", "", "Agent", "cr2", "Term", "seq0", "h51")
condition("h104", "[notBusy]", "!bv6", "seq0", "h100")
par("par0", "seq0")
seq("seq1", "par0")
condition("h119", "Default", "!bv5", "seq1", "NULL")
doElement("h34", "", "start", "Connect_Start", "", "Agent", "cr2", "Term", "seq1", "h119")
doElement("h36", "", "continue", "Connect_End", "", "Agent", "cr2", "Term", "seq1", "h34")
doElement("h116", "", "ringTreatment", "Resp", "", "Agent", "cr2", "Term", "seq1", "h36")
doElement("h101", "", "success", "Connect_End", "", "Agent", "cr2", "Term", "seq1", "h116")
doElement("h1", "", "ring", "End_Point", "", "User", "cr0", "Term", "seq1", "h101")
seq("seq2", "par0")
doElement("h99", "", "ringingTreatment", "Resp", "", "Agent", "cr2", "Term", "seq2", "NULL")
doElement("h112", "", "reportSuccess", "Connect_End", "", "Agent", "cr2",
"Term", "seq2", "h99")

```

**Figure 29** DXL script of the successful BasicCall scenario

This section discussed the scenario metamodel in DOORS. However, in some cases, scenarios may not be defined in the UCM model. Therefore, the scenario part can be absent in the DXL script generated from UCMNAV. Details information about the functions used in Figure 29 are explained in section 4.2.3.

### 3.6. Implementation of the Export

To automate the proposed DXL export mechanism, UCMNAV was enhanced to support new functionalities. A few difficulties were faced along the way, especially given the absence of real architecture and documentation for the tool (hence the need to reverse-engineer a metamodel for UCMs as explained earlier in this chapter).

The original UCMNAV functionalities were kept unchanged. However, new methods were added to many classes to generate DXL scripts from the internal object model. Most of the new methods are based on existing code for saving UCM models to XML files. For instance:

- An `OutputDXL()` method was added to several classes in order to generate DXL function calls describing the core elements and their associations (responsibilities, components, devices), as shown in section 3.3.

- A `SaveDXL()` method was added to the `Hyperedge` class, which invokes the `SaveDXLDetails()` method of the specific hyperedge subclass where additional information needs to be output (e.g. for responsibility references and stubs). The `SaveDXL()` of the `Map` class calls the `SaveDXL()` method on all the hyperedges composing a particular map, and it also generates information on the map components as well as on the file that contains the bitmap version of the map. These new methods are used to export maps and their associations (section 3.4)
- Similar methods were added to the scenario classes, which are invoked by the traversal mechanism during scenario generation. These methods, which are inspired from existing code that exports scenarios in XML [7], generate the DXL code describing scenarios and their associations (section 3.5). The export mechanism requires that the scenario definitions be valid (e.g., the traversal should not stop prematurely due to a condition that cannot be met or to a non-deterministic choice) for the DXL export to work properly.

The framework is hence in place to export new or different types of attributes or UCM elements if needed. Special attention was paid not to change the values of any class property in UCMNAV in order to prevent undesirable feature interactions.

Despite our desire not to modify the existing functionalities, several bugs in UCMNAV caused much inconvenience during the implementation of the DXL export mechanism. For instance, identifiers for UCM objects (e.g., responsibilities and components) kept changing each time a UCM model was saved and loaded. This in turn disturbed the update of the UCM model in DOORS, because our model import approach (to be discussed in the next chapter) relies on the fact that object identifiers do *not* change from one version to the next. UCMNAV was therefore improved, with the help of Gunter Mussbacher, to ensure that identifiers remain unique and unchanged as the UCM model evolves.

### 3.7. Chapter Summary

In this chapter, we have presented an approach to export UCMs from UCMNAV. The tool was enhanced to export a selected subset of the UCM object model in the form of a DXL script. As a start point, a UCM metamodel was reverse-engineered from existing XML

file formats and from other sources. A subset of that metamodel was selected for the export based on several principles (section 3.1). In section 3.2, several candidate export strategies were explored and one based on the direct generation of DXL code was selected. Sections 3.3, 3.4, and 3.5 gave detailed specifications of the formats used to describe the three major parts of the metamodel: core, maps, and scenarios. The implementation of this strategy in UCMNAV was briefly discussed in section 3.6.

The next chapter will address the issue of importing in the DOORS requirements management system the UCM models exported as DXL scripts.

## Chapter 4. Importing UCM Models in DOORS

---

This chapter presents an approach to represent the metamodel discussed in Chapter 3 in the target RMS, Telelogic DOORS, based on the DXL scripts generated from the UCMNAV tool. A DXL library is created to support the import of UCM models in DOORS. This chapter then discusses traceability inside the UCM model and traceability between the UCM model and other requirements.

This chapter is mainly focused on the first time import of a UCM model in DOORS. The issues related to the updating of an existing UCM model are addressed in Chapter 5.

### 4.1. Metamodel of the UCM model in DOORS

Projects, folders and formal modules compose the DOORS hierarchy. *Projects* are used to manage the data related to a specific project, product or process for a team. *Folders* are used to structure the data within the database. Both projects and folders can contain sub-folders, sub-projects, and formal modules. *Formal modules* are containers for requirements information. Typically, formal modules are structured and displayed as a document. However, a formal module also can be structured and displayed as a data file by using user-defined attributes. This facility is used by the UCM import process proposed in this thesis to store UCM objects information, including attributes and graphics, into DOORS.

This thesis proposes that a UCM model be introduced into a target project for better describing functional requirements and testing goals. Figure 30 shows the proposed UCM metamodel as represented in DOORS. This metamodel adds DOORS structuring elements (folders and modules) on top of the metamodel previously presented in Figure 18 (and further detailed in Figure 22, Figure 24, and Figure 27). To import a UCM model into DOORS according to the proposed UCM metamodel, a specific folder, namely *UCM*

*model*, is created under the target project. The imported UCM model is composed of three sub-folders: Core, Maps and Scenarios.

The *Core* folder has three modules: Components, Responsibilities, and Devices. These three modules list the three fundamental UCM element types we decide to preserve in DOORS-specific term, i.e., as objects. The *Maps* folder contains one module, which has the same name as the UCM design model. This module lists the maps and references appearing in maps such as component references, responsibility references, and stubs. The *Scenarios* folder also contains a module (named after the UCM model design name), which contains grouped scenarios.

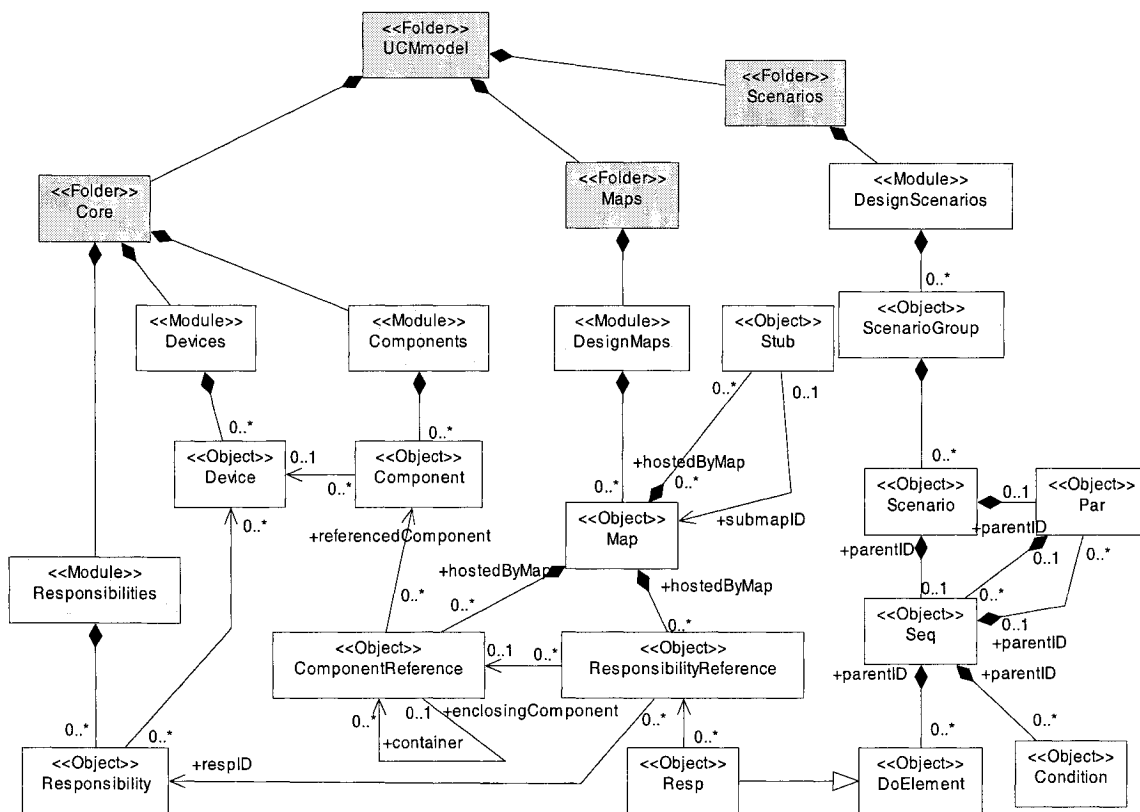

**Figure 30** UCM metamodel in DOORS

DOORS *links* are created to represent the associations found in the UCM metamodel, except for composition relationships. The latter are represented by the containment relationship between the DOORS database items, such as a folder containing modules or other folders, a module containing objects, or an object containing sub-objects.

## 4.2. DXL Library in DOORS

A DXL library is created to accept the UCM model information captured in a DXL script generated by UCMNAV. The DXL library helps to create and update the UCM model in the DOORS database. According to the three divisions (sub-folders) of the UCM meta-model in the previous section, the DXL library is also divided into three parts: core, maps and scenarios.

The following subsections will present the various functions comprising the library. Boolean functions return *true* only if no exceptions are generated during their execution. Appendix B presents the details on one of these functions.

### 4.2.1 Core

```
bool beginOfCoreImport()
```

***Parameters:***

- None

***Description:***

This function is the first function to be called in the import process. It mainly performs the preparation of the import. For the first time import, this function will create the *Core* folder, which is used to save the core part of the UCM model: responsibility module, component module, and device module. Otherwise, this function will remove all the internal link modules at the beginning of the import. In DOORS, an object with an incoming link in the module cannot be deleted until all the incoming links are removed, which is the reason why all the internal link modules need to be removed before the updating of the UCM model in DOORS. Further information about the updating of links in the UCM model is explained in section 5.3

```
bool responsibility( string responsibilityID, string responsibilityName,
                    string theDescription, string processorDemand )
```

**Parameters:**

responsibilityID: String	The identifier of the responsibility.
responsibilityName: String	The name of the responsibility.
theDescription: String	The description of the responsibility.
processorDemand: String	The processor demand in the responsibility.

**Description:**

This function creates or updates one responsibility object in the responsibility module, which is located under the *Core* folder. Each parameter defines the value of one attribute of the object. Each responsibility object has a unique value of “responsibilityID”, which is the key attribute in the responsibility module. The DXL code of this function is presented in Appendix B.

```
bool component( string componentID, string componentName,
                string componentType, string theDescription,
                string hostedDeviceID )
```

**Parameters:**

componentID: String	The identifier of the component.
componentName: String	The name of the component.
componentType: String	The type of the component.
theDescription: String	The description of the component.
hostedDeviceID: String	The identifier of the host device of the component.

**Description:**

This function creates or updates one component object in the component module, which is located under *Core* folder. Each parameter defines the value of one attribute of the object. Each component object has a unique value of “componentID” which is the key attribute in the component module.

```
bool device( string deviceID, string deviceName, string theDescription,
             string speedFactor )
```

**Parameters:**

ID: String	The identifier of the device.
name: String	The name of the device.
theDescription: String	The description of the device.
speedFactor: String	The operation time of the device.

**Description:**

This function creates or updates one device object in the device module, which is located under *Core* folder. Each parameter defines the value of one attribute of the object. Each device object has a unique value of “deviceID” which is the key attribute in the device module.

```
bool endOfCoreImport ()
```

**Parameters:**

- None

**Description:**

This function is the end part of the *Core* model import. It parses the created or updated modules and creates links between those modules according to the attributes which contain the link information. For example, if a component object has a value for “hostedDeviceID”, this function will create a link from the component object to the referred device object in the DOORS database. Section 4.3 will provide more information about link creation during the import. This function also customizes views of the responsibility, component, and device modules to display more attributes, which are not displayed by default in DOORS. If the import is not first time import but an updating, then this function will remove the objects marked as deleted at the end of the import (except for the exceptions discussed in section 5.3).

**Example**

After importing the core part of a UCM model into DOORS, responsibility, component, and device modules are created under the *Core* folder. For each module, the import process defines conventional views automatically. These views list each category of objects

with a selection of attributes. Figure 31 presents an example of the list of responsibilities, the list of components, and the list of devices in views created during the import process. Note the presence of several triangles, which indicate incoming (◀) or outgoing (▶) traceability links created and managed automatically by the DXL library. The pop-up menu of the top part of the figure shows which UCM device is linked to the Simple Telephone component. This information was generated automatically by our import mechanism and can be maintained as the UCM evolves.

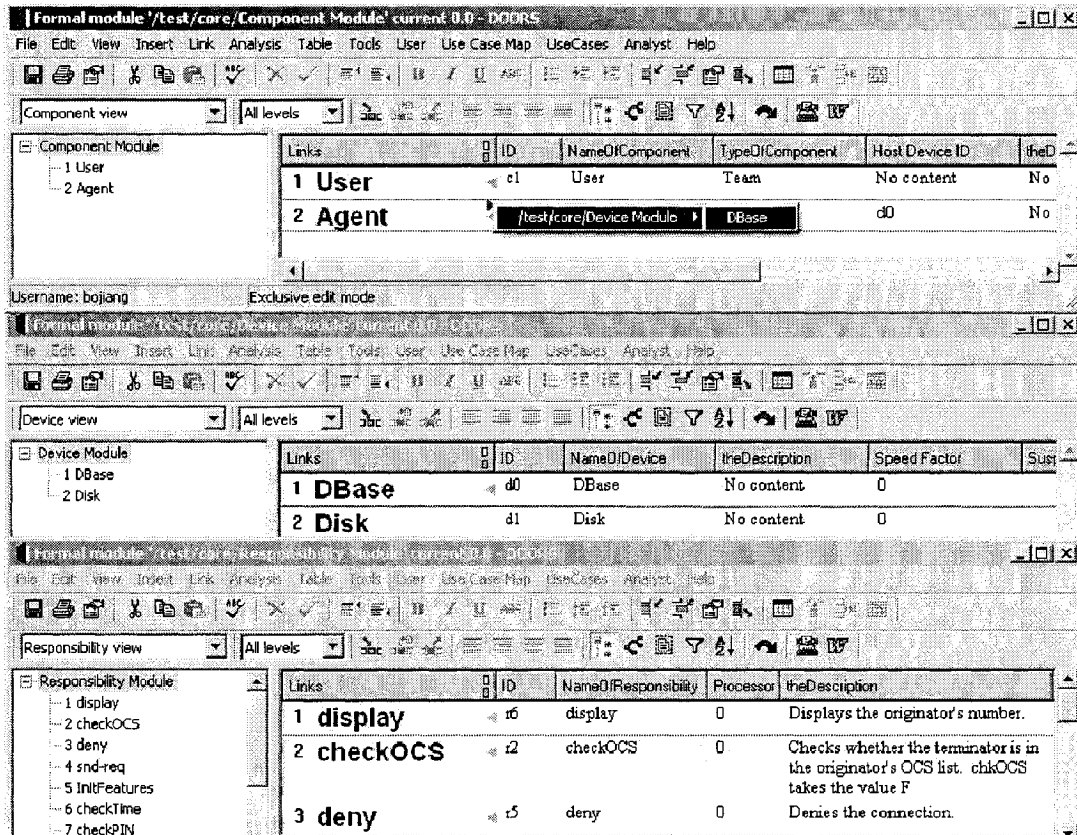

**Figure 31** Core folder for the Simple Telephone example in DOORS

For each module listed in Figure 31, there is a tree-like explorer in the left, which provides the view for the structure of the module and for navigating to a specific object in the module. UCM objects are shown in the right window of Figure 31. They can be displayed in different views that can customize different sorts, attributes, and filters for the displayed objects. The columns in the right window show attributes of the UCM module.

## 4.2.2 Maps

```
bool beginOfMap( string ucmName, string designID )
```

### *Parameters:*

ucmName: String	The name of the UCM model.
designID: String	The identifier of the UCM model.

### *Description:*

This function is the first function to be called in the maps import process. For a first time import, this function will create the *Maps* folder, which is used to save the maps module. During an update, this function creates the map folder and the map module if necessary.

```
bool map( string modelID, string modelName, string graphFileName,  
          string title, string theDescription )
```

### *Parameters:*

modelID: String	The identifier of the map.
modelName: String	The name of the map.
graphFileName: String	The name of the graph (diagram) file of the map.
title: String	The title of the map.
theDescription: String	The description of the map.

### *Description:*

This function creates or updates one map object in the map module located under the *Maps* folder. Each parameter defines the value of one attribute of the object. Each map object has a unique value of “modelID”, which is the key attribute in the map module. The graph file indicated by the “graphFileName” parameter is loaded into the heading attribute of the map object. The diagram must be in Windows *.bmp* (bitmap) format and located in the same directory as the DXL script file of the UCM model.

```
bool respRef( string ID , int fx, int fy ,string hostedByMap,
             string containedByComponent, string respID, string name,
             string theDescription, string direction )
```

**Parameters:**

ID: String	The identifier of the responsibility reference.
fy: Integer	The vertical (Y) coordinate of the responsibility reference on the map.
fx: Integer	The horizontal (X) coordinate of the responsibility reference on the map.
hostedByMap: String	The map hosting the responsibility reference.
containedByComponent: String	The component hosting the responsibility reference.
respID: String	The responsibility referred by the responsibility reference
name: String	The name of the responsibility reference.
theDescription: String	The description of the responsibility reference.
direction: String	The direction of the responsibility reference (for future use).

**Description:**

This function creates or updates one responsibility reference object in the map module located under the *Maps* folder. Each parameter defines the value of one attribute of the object. Each responsibility reference object has a unique ID value. “fx” and “fy” indicate the position of the responsibility reference in the graphical map. In future work, this position information could be used to identify the responsibility reference in the graph of map, and enable clickable diagrams with hyperlinks (this is currently difficult to do with DOORS). “hostedByMap” expresses the parent map which contains the responsibility reference. “containedByComponent” shows the link from the responsibility reference to the parent component reference. “respID” is a link from the responsibility reference to the referred responsibility definition in the *Core* folder.

```

bool compRef( string componentRefID, int  fx, int fy, int width, int height,
              string anchored, string hostedByMap,
              string referencedComponent, string name, string role,
              string parentComponent)

```

**Parameters:**

ID: String	The identifier of the component reference.
fy: Integer	The vertical (Y) coordinate of the component reference on the map.
fx: Integer	The horizontal (X) coordinate of the component reference on the map.
width: Integer	The width of the component reference on the diagram map (for future use).
height: Integer	The height of the component reference on the map (for future use).
anchored: String	The object is anchored or not.
hostedByMap: String	The identifier of map which hosts the component reference.
referencedComponent : String	The identifier of the component referenced.
parentComponent: String	The identifier of the parent of the component reference (if any).
name: String	The name of the component reference.
theDescription: String	The description of the component reference.
direction: String	The direction of the component reference (for future use).

**Description:**

This function creates or updates one component reference object in the map module located under the *Maps* folder. Each parameter defines the value of one attribute of the object. Each component reference object has a unique value of “componentRefID”. “fx”, “fy”, “width” and “height” indicate the position of the component reference in the graphical map. In future work, this position information could be used to identify the component reference in the graph of map, and enable clickable diagrams with hyperlinks (this is currently difficult to do with DOORS). “hostedByMap” expresses the map which hosts the component reference. “referencedComponent” indicates the link from the component reference to the referred component in the *Core* folder. “parentComponent” links to the containing component reference in the same map, if any.

```
bool stubRef( string ID, int fx, int fy, string hostedByMap,
             string name, string stubType, string submapID )
```

**Parameters:**

ID: String	The identifier of the stub.
fy: Integer	The vertical (Y) coordinate of the stub on the map.
fx: Integer	The horizontal (X) coordinate of the stub on the map.
hostedByMap: String	The identifier of the map which hosts the stub.
name: String	The name of the stub
stubType: String	The type of the stub.
submapID: String	The list of submaps contained in this stub.

**Description:**

This function creates or updates one stub object in the map module located under *Maps* folder. Each parameter defines the value of one attribute of the object. Each stub reference object has a unique identifier. Again, “fx” and “fy” indicate the position of the stub reference in the graphical map (for future clickable maps). “hostedByMap” refers to the map that contains the stub. “submapID” is a String that in fact contains a semicolon-separated list of map identifiers. It is used to create links from the stub to its plug-in submaps.

```
bool endOfMap( string ucmName, string designID )
```

**Parameters:**

ucmName: String	The name of the UCM model.
designID: String	The identifier of the UCM model.

**Description:**

This function indicates the end of the import of one map model. It parses the created or updated modules and creates links between those modules according to the attributes which contain the link information. For example, if one component reference object has a value set for “referencedComponent”, this function will create a link from the component reference object to the referred component object. Section 4.3 discusses automatic links

creation in more details. This function also customizes views of the map module to display more important attributes which are not displayed by default in DOORS. If the import is not a first-time import but an updating, then this function will remove the objects marked as deleted. Some exceptions may occur during such deletion, and section 5.3 will discuss their handling.

### **Example**

After a first-time import into DOORS, a map module (whose name is that of the UCM design) is created under the *Maps* folder. A suitable user-defined view, where each category of objects is listed with selected attributes, is created by the import functions. Figure 32 illustrates the list of maps, component references, responsibility references and stubs in the pre-defined view for the simple telephone UCM. Note that the name of each map is used in the overview tree widget on the left, and that the elements of each map are also accessible from this view.

In the left of Figure 32, a tree-like explorer provides the view for the structure of the map module and for navigating to a specific object in the module. For each map, a bitmap figure is loaded to show the map information visually, as seen in the column *Map*. DOORS provides support for picture objects in Windows bitmap (BMP) and Windows Meta File (WMF) formats. Unfortunately UCMNAV does not support the export of maps in these formats. However UCMNAV supports, among others, the export of maps in Encapsulated PostScript (EPS). In the approach described by this thesis, Ghostview [15] is used to convert the EPS map files generated by UCMNAV to BMP files readable by DOORS during the import. A simple batch file is provided to automate this conversion for all the maps in a directory.

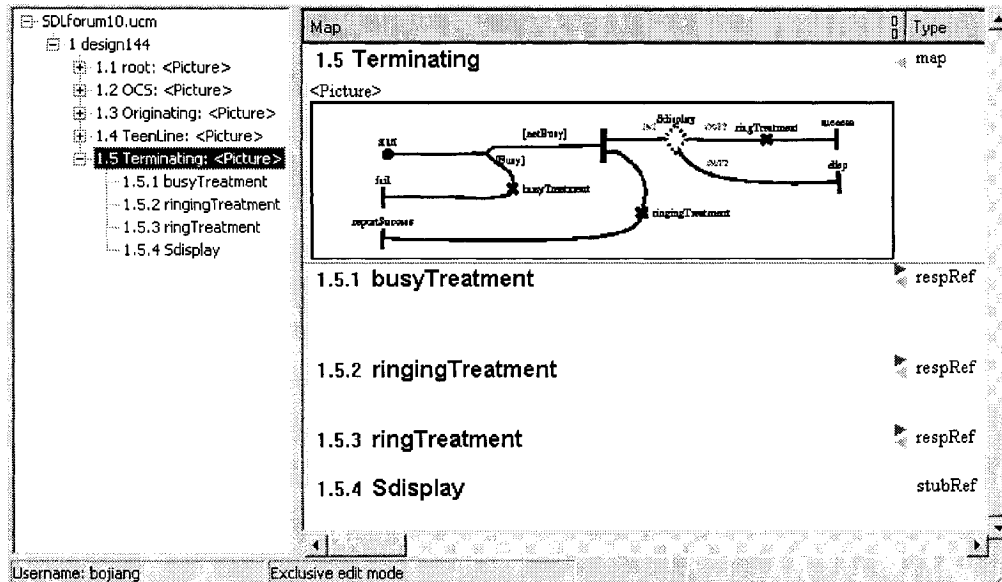

Figure 32 Maps for the Simple Telephone System in DOORS

### 4.2.3 Scenarios

All the scenarios concepts from our metamodel are exported to DOORS, including their relationships. However DOORS links are not used to express the inter-relationships between scenario elements because there is a large quantity of such relationships in any given scenario. This would slow down the import and update processes and take more space for no apparent benefit. Instead, composition and sibling relationships between DOORS objects are used for describing these inter-relationships in scenario.

```
bool beginOfScenario( string ucmName, string designID )
```

**Parameters:**

ucmName: String	The name of the UCM model.
designID: String	The identifier of the UCM model.

**Description:**

“designed” is used to identify the UCM model. This function is the first function to be called in the scenario import process. It mainly performs the preparation of the import of scenarios. During the first-time import, this function creates the *Scenarios* folder, which

is used to save the scenario module. During an update, this function deletes all the scenario elements and marks other objects, such as `scenarioGroup` and `scenario`, as “deleted”.

```
bool scenarioGroup( string Name, string ID, string theDescription )
```

**Parameters:**

ID: String	The identifier of the scenario group.
name: String	The name of the scenario group.
theDescription: String	The description of the scenario group.

**Description:**

This function creates or updates one scenario group object in the scenario module. Each parameter defines the value of one attribute of the object. Each scenario group object has a unique identifier, which is the key attribute in the scenario module. A group can contain multiple scenarios, which are created using the `scenario` function.

```
bool scenario( string Name, string ID, string theDescription )
```

**Parameters:**

ID: String	The identifier of the scenario.
name: String	The name of the scenario.
theDescription: String	The description of the scenario.

**Description:**

This function creates or updates one scenario object in the scenario module. Each parameter defines the value of one attribute of the object. Each scenario object has a unique identifier which is the key attribute in the scenarios module. Scenarios contain many types of elements organized in sequence or in parallel.

```
bool seq( string ID, string parentID )
```

**Parameters:**

ID: String	The identifier of the seq.
parentID: String	The parent of the seq.

**Description:**

This function creates one sequence object for the current scenario in the scenario module. Sequence objects are not updated; they are recreated at every update. Each parameter defines the value of one attribute of the object. Each sequence object has a unique identifier, which is the key attribute in the scenario module. Sequences contain various elements and sub-parallel sequences.

```
bool par( string ID, string parentID )
```

**Parameters:**

ID: String	The identifier of the par.
parentID: String	The parent of the par.

**Description:**

This function creates one par object in the scenario module. Par objects are not updated; they are recreated at every update. Each parameter defines the value of one attribute of the object. Each par object has a unique identifier, which is the key attribute in the scenarios module. Par objects contain sub-sequences of various types of elements.

```
bool doElement( string ID, string hyperEdgeID, string Name,
               string doType, string theDescription,
               string parentID, string preSibling )
```

**Parameters:**

ID: String	The identifier of the doElement.
hyperEdgeID: String	The identifier of the original UCM hyperedge referred by the doElement.
doType: String	The type of hyperEdge referred by the doElement. The type is one of the following: Resp, Start, End_Point, WP_Enter, WP_Leave, Connect_Start, Connect_End, Trigger_End, Timer_Set, Timer_Reset, or Timeout.
theDescription: String	The description of the doElement.
ParentID: String	The identifier of the parent (seq or par) of the doElement.
Presibling: String	The identifier of the previous sibling of the doElement.

**Description:**

This function creates one doElement object in the scenario module. doElement objects are not updated; they are recreated at every update. Each parameter defines the value of one attribute of the object. Each doElement object has a unique identifier, which is the key attribute in the scenario module. “hyperEdgeID” indicates the original UCM element referred by the doElement. However, only one kind of hyperedge referred by doElement objects is currently imported into the map module, namely responsibility reference. The “hyperEdgeID” parameter for elements of type Resp hence translates to a DOORS link from the doElement to the referred responsibility reference in the *Maps* folder. “parentID” and “preSibling” are used to locate the position of the doElement in the scenario, which is represented as a tree. They are not converted to DOORS links

```
bool condition( string ID, string label, string expression,
                string parentID, string preSibling )
```

**Parameters:**

ID: String	The identifier of the condition.
label: String	The label attached to the condition.
expression: String	The Boolean expression used in the selected scenario branch, where the condition applied.
parentID: String	The identifier of the parent (seq or par) of the condition.
presibling: String	The identifier of the previous sibling of the condition.

**Description:**

This function creates one condition object in the scenario module. Condition objects are not updated: they are recreated at every update. Each parameter defines the value of one attribute of the object. Each condition object has a unique identifier, which is the key attribute in the scenarios module. “parentID” and “preSibling” are used to locate the position of the condition in the scenario, which is represented as a tree. They are not converted to DOORS links.

```
bool endOfScenario(string ucmName, string designID )
```

**Parameters:**

ucmName: String	The name of the UCM model.
designID: String	The identifier of the UCM model.

**Description:**

This function is the end part of the scenario model import. It parses the created or updated modules and creates links between those modules according the attributes which contain relevant link information. For example, if the one doElement object has a value of “hyperEdgeID” and the “doType” is “Resp”, then this function will create a link from the doElement object to the referred responsibility reference object in the Maps folder. Section 4.3 discusses link creation in more depth. This function also customizes the view of the scenario module to display important object attributes which are not displayed by default in DOORS. If the import is updating a previously model, then this function will

remove the objects marked as “deleted” at the end of the import. Some exceptions may occur, which are described in section 5.3.

**Example**

After the first-time import of the scenario part of a UCM model into DOORS, the scenario module is created under the *Scenarios* folder. A scenario view, where objects are listed with selected attributes, is created during the import process. Figure 33 illustrates the list of scenarios and their sequential and parallel elements and conditions (with some of their attributes) of the Simple Telephone UCM. The tree list in the left part of the figure shows the structure of scenarios in the Simple Telephone Example. Note the triangles on the side of some of the scenario elements; they indicate outgoing traceability links from the scenario steps to the referred path elements traversed by this scenario. This links information was generated automatically by our import mechanism and can be maintained as the UCM evolve.

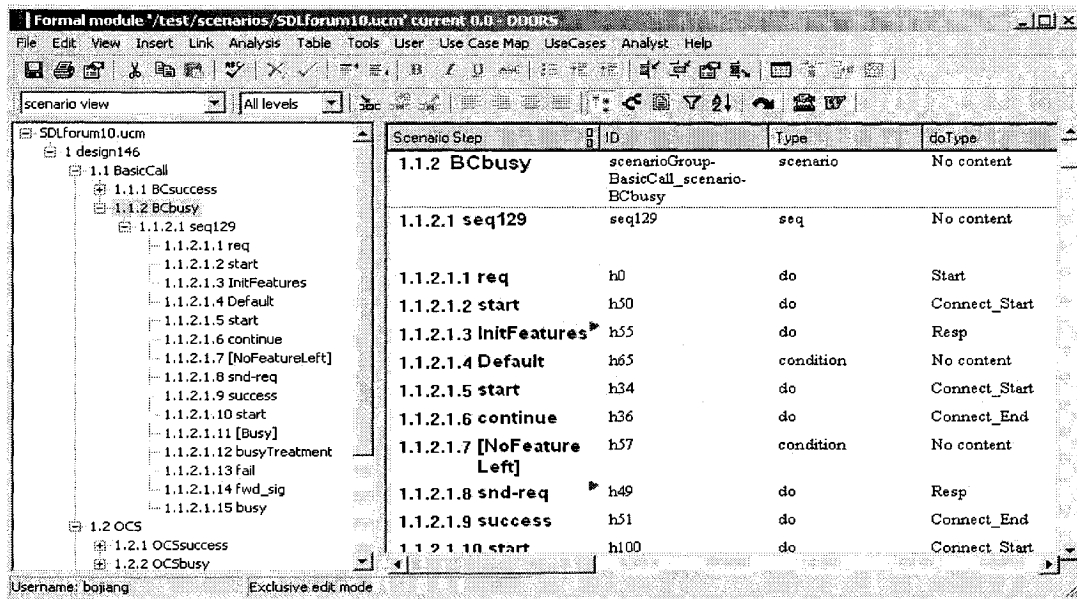

**Figure 33** Scenarios for the Simple Telephone System in DOORS

This section discussed the scenario library in DOORS, which supports DOORS importing scenarios defined UCM. However, UCM models do not always contain scenarios. In some cases, the UCM model may not contain scenarios.

### 4.3. Automatic Link Creation

Links are a feature of DOORS essential for creating and navigating traceability relationships between requirements, which are represented as objects in formal modules. The relationship between two objects in the DOORS database is established using a link. By definition, a link goes from the *source object* to the *target object*. However, links can be followed in either direction and DOORS provides tools that facilitate this navigation. If an object is the target object of a link, this link is called an *incoming link* of the object. If an object is the source object of a link, this link is called an *outgoing link* of the object.

In the proposed DOORS representation for UCMs, links are divided into internal links and external links according to their different scopes. The links between the objects inside the UCM model are called *internal links*. Otherwise, the links are called *the external links*. Internal links implement the associations found in the metamodel of Figure 18. They are created and updated automatically while importing a UCM model into DOORS. The internal links tightly combine the three parts of the UCM model, i.e., the core, the maps, and the scenarios. Since only internal links are created when a UCM is imported, the discussion about external links will be left to next chapter, where links between the imported UCM model and other requirements will be created, and analyzed, and maintained.

To describe precisely the nature of links, DOORS allows the definition of *link attributes*. By taking advantage of this DOORS functionality, internal links are assigned different types according to the various relationships between the linked UCM objects. For example, a component can have a “hosts” link to a device, indicating the host device of a particular component. Figure 34 gives an overview of the various types of internal links created during the import, whereas Table 2 establishes the correspondence between these links and the original associations from the metamodel (Figure 30). These links help DOORS users to understand and exploit the relationships between different UCM objects.

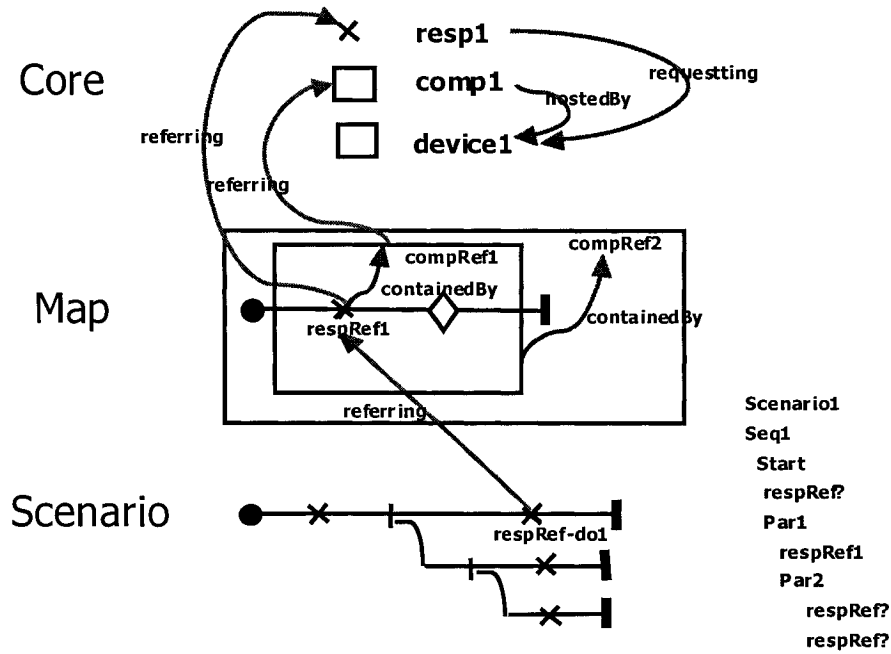

**Figure 34** Internal links in an imported UCM model

Link type (DOORS)	Source class (metamodel)	Destination class (metamodel)
referring	ResponsibilityReference	Responsibility
referring	ComponentReference	Component
referring	Resp	ResponsibilityReference
hostedBy	Component	Device
requesting	Responsibility	Device
containedBy	ResponsibilityReference	ComponentReference
containedBy	ComponentReference	ComponentReference

**Table 2** Mapping from metamodel associations to DOORS links

Through the internal links, relationships such as assignment of responsibility references to component references, containment amongst component references, or request of responsibilities to devices can be quickly visualized and explored using existing DOORS functionalities. DOORS uses small triangles to indicate the existence of incoming (◀) or outgoing (▶) links. Clicking on such triangles brings the lists of link types and their linked objects. Links can also be exploited by queries or transformations in DXL scripts.

## 4.4. Chapter Summary

This chapter discussed the mechanisms used to import a UCM model into DOORS for the first time. In section 4.1, a class diagram is used to illustrate the metamodel of Use Case Maps as represented in DOORS. Section 4.2 described the DXL library supporting the import of UCM models into DOORS. Section 4.3 presented how the internal links implement the associations of our metamodel, hence enabling exploration of various UCM elements and their relationships as a whole. The next chapter will focus on evolution management by presenting how external requirements are linked to the UCM model, how evolving requirements will be reported back to UCMNAV to update the UCM model, and how an evolving UCM model is updated in DOORS.

## Chapter 5. Managing the Evolution of Scenarios and Requirements

---

This chapter discusses how to manage the evolution of scenarios and requirements during the development process. Section 5.1 presents how UCM model elements are linked to external requirements in the target RMS. Section 5.2 shows how evolving requirements can trigger modifications to the UCM model. Finally, section 5.3 explains how the DOORS database is automatically updated when re-importing a new version of a UCM model, after modifications.

### 5.1. Links from/to External Requirements

Having been imported into DOORS, a UCM model can be used as a supplement to existing requirements, including user requirements, system functional requirements, performance requirements, and testing requirements. Requirements engineers who are familiar with both the UCM notation and DOORS can analyse the relationships between the original textual requirements in DOORS and the imported UCM model, and then create appropriate links between them. These links combine the UCM model and other textual requirements to express more precise and complete requirements for the target system.

External links also can be used to preserve the consistency between a UCM model and other requirements. Once requirements or the UCM model are changed, DOORS will flag the external links connecting these two views automatically as *suspect links*. These suspect links act as change notifications for the requirements. These proactive suspect links ensure that each user knows about changes made by another user.

In practice, links could be created between external requirements and any object in the imported UCM model. However, DOORS users are encouraged to create links only to objects in a UCM model that are automatically maintained during the import. Some of the objects, although they are part of the UCM model, are deleted and recreated at each

import. This is the case for all the elements composing scenarios (par, seq, doElements, and conditions). Hence, links should not be created from/to these objects.

### ***Guidelines to create external links from/to the UCM model***

- Component references and responsibility references represent specific usages of elements part of the system structure and behaviour. Most parts of system requirements can be linked to component references or responsibility references in the UCM model.
- A map is used to describe a system or a sub-system including its structure and behaviour. It can be considered as a visual use case. Therefore, it could be linked to a functional requirement or to a use case in the user requirements.
- A stub is often used for the decomposition of the UCM model. It is a reference to sub-systems. Dynamic stubs could be used for a product family. Requirements should not be linked to a static stub directly. Instead, it is suggested to link requirements to the corresponding map referred by the stub.
- Components and responsibilities are used to describe specific elements of the system structure and behaviour. References to these elements can appear in many places in a UCM model. Links from system requirements are encouraged, but not to/from user requirements.
- If a requirement is related to a performance resource such as a processor, a disk, or another type of service in a system and the resource is described as a device in the UCM model, then a link between the requirement and the corresponding device should be created.
- Regarding test requirements, related test cases could be grouped as test suites and linked to the corresponding scenario group in the UCM model.
- Scenarios in the UCM model could be linked to the related functional requirements or from test goals for the target system. However, individual scenario step should not be linked to external requirements or test steps because a scenario is usually viewed as a unit of functional requirement or a test goal and should not be broken up. If a requirement is related to a system action during the scenario path, it should be linked to the responsibility reference referred by that scenario step.

- Links are usually created from requirements to higher-level requirements (e.g., from system requirements to user requirements). That is the model supported by the link access policy in DOORS: a user must have “Read” and “Modify” access rights at the source object in order to create a link. In most cases, the higher-level requirements are read-only to the UCM modellers. Since UCM modellers must have “Modify” access right to in order to create a link, they can only create links from the UCM model, where they have write access, to the higher-level requirements. Therefore, the default type of links created between the UCM model and external requirements are “Satisfies”.
- The UCM modellers are not encouraged to created links from the UCM objects to lower level requirements. All of the links in the project should follow in the same direction for traceability analysis purpose, which is bottom up in our case. Therefore, “Satisfies” links should be created from lower level requirements to the UCM model by whoever is responsible of those lower level requirements.

Following these guidelines, a UCM model should be linked to higher-level requirements such as user requirements. It also can be linked from system requirements and functional tests requirements as shown in Figure 35.

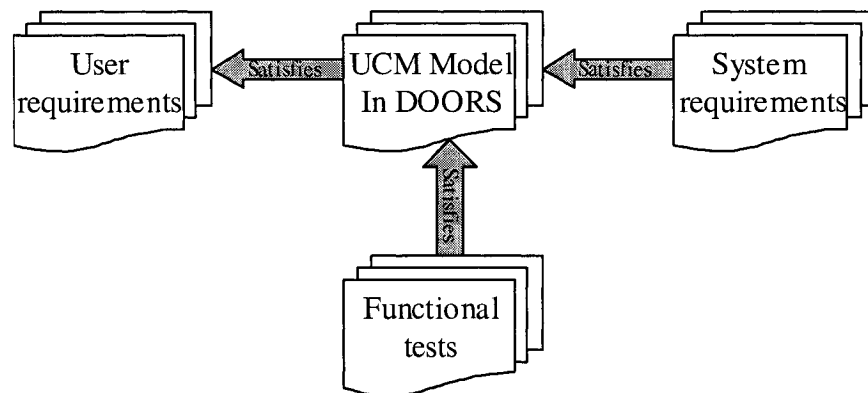

**Figure 35** Links between a UCM model and external requirements

## 5.2. Evolving UCM Models According to Changed Requirements

Requirements are very likely to be changed during the development process. This section discusses how to evolve the UCM model when its linked requirements are modified in the RMS.

In general, once a requirement is changed, lower level requirements (e.g., at the software level) that are linked to it should be checked and kept consistent with its new version. Furthermore, higher-level requirements (e.g., at the user level) that are linked from it also need be checked for satisfaction. People may argue the higher-level requirements do not have to be checked because a requirement should always be consistent with its higher-level requirements when it is changed. That argument is based on the assumption that the maintainer of the requirement understood the higher-level requirements correctly. However, since requirements are expressed in nature language and may be created by different people, maintainers may have different understandings of the same requirement. This drawback of requirements expressed in nature language encouraged many people to advocate in favour of formal requirements specification, which are outside the scope of this thesis. Another reason to check higher-level requirements is that the latter may be refined and clarified when creating or updating lower level requirements.

Tracking the traceability between various requirements and keeping them consistent has always been a difficult requirements management issue. As mentioned in section 4.3, requirements management systems use links to manage requirements evolution. As discussed in the last section, a UCM model could be linked to and from various requirements such as user, test, and system requirements. If *user* requirements are changed after some refinements, e.g., resulting from further communications with customers or other stakeholders, the linked UCM objects will be triggered as having suspect outgoing links by the RMS. If lower level requirements, such as test requirements or system requirements, are refined, then the changes may have an impact on the linked UCM objects. From the UCM point of view, the links between them will be triggered as suspect incoming links. The suspect links, including incoming and outgoing links, indicate the UCM objects that need to be verified according to the changed requirements, and changed if necessary. In the DOORS representation of the UCM model, suspect links are

defined as attributes in the pre-defined views customized by the import process, as shown in Figure 36.

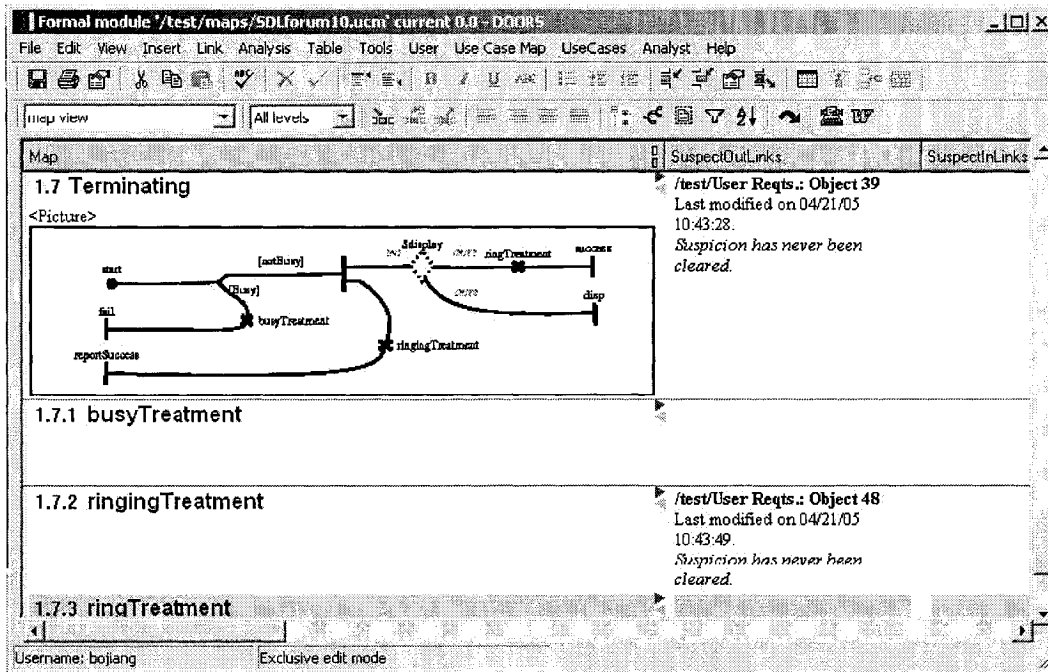

**Figure 36** Suspect links between a UCM model and external requirements

### 5.2.1 Generating the Changed Requirements from DOORS

If the linked external requirements are changed, the UCM model should be verified and may need to be modified to match the new requirements. However, the UCM model should not be modified from DOORS. The approach described in this thesis does not implement a UCM editor in DOORS as such functionality is best supported in an external tool like UCMNAV. Therefore, modifications need to be done outside of DOORS, in UCMNAV.

To provide guidance in the update of the UCM model, a report is generated by DOORS that emphasizes detailed information about the changed requirements and their related UCM objects. Our approach provides an automated report generation function implemented in DXL.

The report function is available from a new menu item in DOORS, which appears in all the views. This function parses all the UCM objects in the current project. For those UCM objects with suspect links, the report function extract their names, types, identifiers, suspect link types, old object content and new object content as shown in Figure 37. All

these modifications are reported in a text file that can then be opened by the UCM model maintainer in any text editor. One thing to be emphasized is that we are not generating a list of modifications to the UCM model, but a list of changes from the requirements linked to the UCM model.

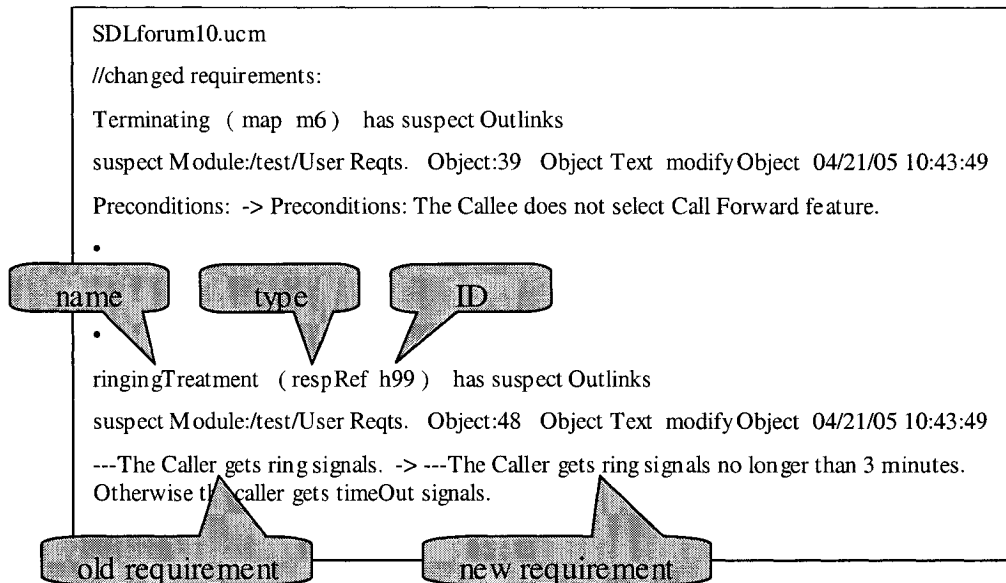

**Figure 37** Report on changed requirements generated by DOORS

## 5.2.2 Evolving the UCM Model in UCMNAV

UCM models can be improved gradually during the development process to show a more precise high-level architecture of the target system. These may be caused by changed requirements or any other reason. In particular, once we have linked the UCM model to external requirements, modifications to these the requirements may trigger changes to the UCM model. This section mainly discusses how DOORS-generated reports on changed external requirements may accelerate the improvement of the UCM model in UCMNAV.

Reports generated by DOORS do not include the entire UCM model but they specify the UCM model name. The UCMNAV user can hence load the corresponding UCM model.

If a UCM object has a suspect outgoing link, which indicates a change in a higher-level requirement, then it needs to be checked and kept consistent with the new requirement. For instance, according to the report in Figure 37, a precondition was changed and the selection policy of the sub-map “Terminating” should be changed ac-

cordingly. Also, the requirement of the responsibility “ringingTreatment” has been changed to “The Caller gets ring signals no longer than 3 minutes. Otherwise the caller gets timeout Signals” instead of “The caller gets ring signals”. Therefore, a timer is added before “ringingTreatment”, the timeout exception sends “TimeOut” signals to both the caller and the callee through “ringTimeOutTreatment”.

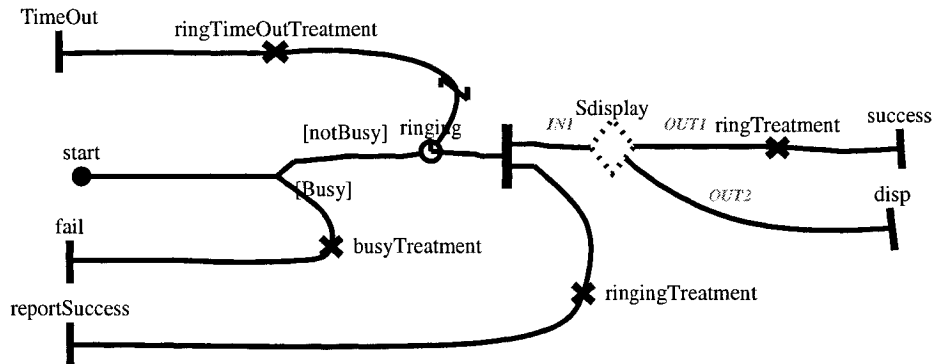

**Figure 38** The modified UCM model

If a UCM object has a suspect incoming link, which indicates a changed in a lower-level requirement, then the UCMNAV user needs to check that the updated requirement still satisfies the UCM. If this is the case, then no action is required on the UCM model. Otherwise, if the updated requirement clarifies the UCM object, then the UCM model should be refined accordingly, or else the user who modified the linked requirement needs to be informed of the inconsistency.

### 5.3. Evolving the DOORS View According to Changed UCM

The last section discussed how the UCM model can evolve during the developing process. New versions of the UCM model can be saved in different files, if desired, to preserve the history of modifications. However, the identifier of the UCM model, the *design name*, will remain unchanged in each version, which ensures the right UCM model in DOORS will be updated. The new version of the UCM model can be re-exported to DOORS through the DXL script generated from UCMNAV. The DXL script may use a new file name according to the new version of the UCM model. This section explains how an existing UCM model in DOORS is updated while executing the new DXL script.

### 5.3.1 Algorithm for Managing Evolving UCM Elements

When the new DXL script is loading and executing in DOORS, the UCM model is updated in DOORS according to the following algorithm, which is composed of four steps:

***Step 1: Pre-process the UCM model.***

Before updating concrete objects, some pre-processing needs be performed on the existing UCM model:

- *Remove internal links inside the UCM model.* Internal links shows the relationships between the UCM objects. In the update process, internal links may affect the updating of UCM objects due to a restriction when deleting an object in DOORS: an object cannot be deleted when it has an incoming link. This restriction prevents a requirement object from being deleted when there are other requirements “depending” on it. For instance, if one component in the UCM model has some incoming links from some structure objects in the system requirement, which provides more detailed information about the component, then it cannot be deleted. Otherwise, those structure objects in the system requirement would become irrelevant to upper-level requirements. Fortunately, we have total control over the links between the UCM model elements, and they can hence safely be removed.
- *Delete all the scenario steps, such as seq, par, doElement, condition.* They are always recreated at each update. The reason to do this pre-processing is that scenario steps do not exist as individual requirements but describe bits and pieces of one requirement: a scenario. Moreover, changes of scenario steps can be tremendous at each update. For instance, if one a scenario step is changed, then all the following scenario steps will be affected. Links from external requirements should be created to scenarios, not to their steps.
- *Set the “deleted” attribute of all UCM objects to “true”.* DOORS does not provide a function to recognize the objects that should be removed after having updated the UCM model. The update process proposed here uses an additional Boolean attribute *deleted* for determining the status of UCM objects.

**Step 2: Update UCM objects.**

After having pre-processed the existing UCM model in the DOORS database, the update process loads and executes DXL function calls for elements from the new version of the UCM model. For each object listed in the DXL script, the updating process searches the UCM model using the value of the key attribute which is unique in the UCM model. If the object is found in the existing UCM model, the values of its attributes are compared with the corresponding parameters in the function call for this object. All relevant attributes with different values are updated. Then the *deleted* attribute is changed to *false*. If the object listed in the DXL script is not found in the existing UCM model, then a new object will be created with all the attributes defined in the DXL script. The default value of the *deleted* attribute in new UCM object is *false*. The *deleted* attribute is used to record the status of UCM objects by the update process.

Some of the attributes of UCM objects record their position information in a diagram or other information not so relevant from a requirements viewpoint (see Table 3). Changed values for these attributes will *not* affect the modification history of the UCM object, trigger suspect links to linked requirements, or change the notification bar in the UCM module.

Modules Attributes	Core	Device	Component	Maps	Scenarios
	Deleted hasIncomingLink	Deleted hasIncomingLink	Deleted hasIncomingLink	Deleted hasIncomingLink fx fy width height direction stubType	Deleted hasIncomingLink

**Table 3** Attributes not affecting histories, suspect links, and the notification bar

**Step 3: Remove objects that have disappeared in the new UCM model.**

After all the new objects in the DXL script have been imported into the DOORS database, a post-processing step is performed. The *deleted* attribute of all the UCM objects in DOORS will be checked. The “deleted” objects (where the value is *true*) without incoming links are removed from the UCM model. The “deleted” objects with incoming links cannot be deleted due to the restriction in DOORS. Their *hasIncomingLink* attribute is however set to *true* during the update process. Their on-empty set of incoming links in-

icates that some lower-level requirements depend on them. The UCM model user may inform the requirements manager of those lower-level requirements and request the removal of the links between those lower-level requirements and the “deleted” UCM objects. Once those links are removed, the UCM model manager can eliminate “deleted” objects manually.

#### ***Step 4: Create internal links***

This step is concerned with the creation of internal links between the related UCM objects according to their association attributes. Adding or removing internal links does not trigger suspect links to/from external requirements because DOORS does not consider them as major changes to requirements.

As mentioned in section 4.1, the composition relationships between UCM objects are represented by containment relationships between the DOORS database objects. If there is a parent-child relationship between an updated UCM object and its parent UCM object, then the updating process does not have to verify whether the relationship is changed or not. That is due to the fact that UCMNAV does not provide a mechanism to move objects to other hosting objects. For instance, a component reference cannot be moved to another map. Also, a scenario cannot be moved to another scenario group.

### **5.3.2 Managing Evolving UCM Links with External Requirements**

As mentioned in section 5.2, modifications to external requirements cause suspect links in the linked UCM objects. Some UCM objects with suspect links are very likely to require some changes in a new iteration of the development cycle. When they are re-imported into DOORS, their new description will clear their suspect links. In DOORS, changing one requirement will cause its linked requirements to have suspect links. If its linked requirements are modified after getting suspect links, then these suspect links will be cleared. The update process may also update some UCM objects without suspect links. If these objects have external links to/from other requirements, then their new description will cause suspect links in their linked requirements, which in turn will suggest that the external requirements should be revisited.

## 5.4. Chapter Summary

This chapter presented how UCMs are linked with other requirements in the RMS and how their inter-dependencies can be managed as they evolve. Since UCMs are introduced into the RMS as traceable objects, they can be connected with various external requirements through different types of links. Principles for creating useful links were mainly discussed in section 5.1. In section 5.2, we introduced a report mechanism for the RMS which summarizes changed requirements in order to promote the evolution of the UCM model. Section 5.3 described an algorithm for updating UCMs in the RMS and discussed the impact to the existing requirements during the update process. The next chapter will illustrate and validate the approach from end-to-end with a supply chain management case study.

## Chapter 6. Case Study: Supply Chain Management

---

In this chapter, our approach is applied to and validated against a *Web Services Interoperability* (WS-I) case study, which contains a *Supply Chain Management* (SCM) business process [36][37]. Our case study illustrates how our approach can improve the overall quality of requirements management by introducing a UCM model into the target RMS and, more importantly, how both views can be kept complete and consistent as they evolve. The UCM model used in chapter is based on the model created by Weiss and Amyot [38][39].

SCM models a retailer system that offers goods to consumers. To fulfill orders, the retailer has to manage stock levels in its warehouses. When an item in stock falls below a certain threshold, the retailer must restock the item from the relevant manufacturer's inventory. In order to fulfill a retailer's request, a manufacturer may have to execute a production run to build the finished goods [36].

In section 6.1, initial informal requirements are provided for SCM. Then a UCM model for SCM is created and exported to the RMS in section 6.2. Section 6.3 presents how changes to the UCM model affect the RMS database and links to other related requirements. Section 6.4 describes how the UCM model is in turn affected by changes to related requirements in the RMS. A discussion of the main benefits and a comparison with existing tools follow in section 6.5.

### 6.1. Initial Requirements for SCM

In this case study, user requirements, system requirements and test requirements are used to describe the supply chain management system in the target RMS. They are adapted and simplified from the requirements listed in [36][37]. In general, requirements management systems can import requirements from various sources, including word processors. For instance, we can import the original SCM requirements into DOORS, leading to

an initial database of requirements objects. These requirements objects can be more or less structured, depending on the quality of the source document.

### 6.1.1 User Requirements

Use cases are an effective and widely used technique for describing user requirements. They can help capture the high level requirements of a system from a user's viewpoint. This case study adapts the SCM use cases listed in [36] as a basis for user requirements. Since this document contains twenty-seven pages and cannot be entirely reproduced in this thesis, most of use cases in [36] are abstracted to single-paragraph descriptions except for Use Case 3, which will be described in detail and fully linked with the UCM model for SCM.

The actors of the system, which will be referenced in the upcoming use cases, are summarized in Table 4.

Actor	Description
Administrator	A party that monitors and administers the system.
Consumer	A party that wishes to shop for goods and products.
Monitoring System	A party that logs and checks the events.
Manufacturing System	A party that manufactures products.
Retailer System	A party that sells products to the general public.

**Table 4** Actors participating to the use cases

The main use cases are summarized here. Table 5 describes the normal path Use Case 3 in more detail, and Table 6 describes an exceptional path for the same use case. These will be modified in our UCM model.

- *Use Case 1 – Purchase Goods:* A Consumer goes to the Retailer Web site with the intent of purchasing electronic products.
- *Use Case 2 – Source Goods:* The Retailer System locates the ordered goods in a warehouse and requests shipment.
- *Use Case 3 – Replenish Stock:* The Retailer System orders goods from a manufacturer to replenish its stock for a particular product in a particular warehouse.
- *Use Case 4 – Supply Finished Goods:* The Manufacturing System processes a purchase order from a warehouse.

- *Use Case 5 – Manufacture Finished Goods:* The Manufacturing System initiates a production run to replenish the stock levels of a specified product.
- *Use Case 6 – Log Events:* The Monitoring System logs events related to the execution of other use cases.
- *Use Case 7 – View Events:* The Administrator views the event logs by setting certain criteria.

Step	Actor	Description	Branches	
			Condition	Location
1.	Retailer System	The Retailer System constructs a purchase order for the product with the necessary quantity to bring the product up to its maximum level for that warehouse.		
2.	Retailer System	Place Order. The Retailer system submits the purchase order to the relevant Manufacturing System (Brand1, Brand2 or Brand3) as dictated by the product.		
3.	Manufacturing System	Validate Order.	Malformed order or invalid product or invalid quantity	ALT 1
4.	Manufacturing System	Send an acknowledgement back to the Retailer System.		
5.	Manufacturing System	The Manufacturing System constructs a shipment of the requested quantity of product.	Unconditional	Use Case 4
6.	Manufacturing System	The Manufacturing System ships the goods and sends a shipping notice to the warehouse. The shipping notice is the business level reply to the purchase order.		
7.	Retailer System	When the Retailer System receives the shipping notice, an acknowledgement is sent back to the Manufacture.		
8.	Retailer System	Upon receipt of the shipment, the warehouse updates its product inventory level based on receipt of the shipped order.		

**Table 5** Primary path of Use Case 3

Step	Actor	Description	Branches Condition Location	
1.	Manufacturing System	The Manufacturing System rejects the order either due to a malformed order, a request for a product that does not exist, or a request for an invalid quantity (e.g. zero or more than the max level for that product). A reply, containing an application error message, is sent back to the Retailer System.		

**Table 6** Exception path of Use Case 3

### 6.1.2 System Requirements

The system requirements used in this case study are not component-based. Detailed architecture information is not provided. It mainly describes what functions the SCM system should provide.

The entire system requirements are listed in Appendix A. Since in our example we plan to apply changes to the Replenish Stock functionality in the UCM model, system requirements related to Replenish Stock are listed in Table 7.

System	Requirements
Retailer System	The warehouse should be able to build the order for a manufacturer.
Retailer System	The warehouse should be able to select the appropriate manufacturer.
Retailer System	The warehouse should be able to place the order to the selected manufacturer.
Retailer System	The warehouse should be able to receive the products shipped by the manufacturer.
Retailer System	The warehouse should be able to update its stock upon receipts of goods.
Retailer System	The warehouse should be able to send acknowledgement back to the manufacturer after receiving goods.
Retailer System	The warehouse should be able to determine the replenishment is time out or not.

**Table 7** Functional requirements related with Use Case 3: Replenish Stock

### 6.1.3 Test Requirements

Test requirements contain test cases and test scenarios whose goal is to validate the SCM system. They are adapted from the validation scenarios defined in [38][39]. To simplify the test requirements, concrete steps in validation scenarios are not provided in Table 8 since they will not be linked to scenarios in the UCM model.

Test Case and Validation Scenario		Description
<i>Test Group 1: RejectOrder</i>		<i>The product order gets rejected (because the product does not exist or because none of the goods can be found in any of the warehouses).</i>
Test Cases	ProductDoesNotExist	The order is rejected because the product does not exist.
	InsufficientStock1WH1Item	The order is rejected because the desired quantity of goods is not available in the single warehouse.
	InsufficientStock1WH2Items	The order is rejected because the warehouse has insufficient stocks for all the desired products.
	InsufficientStock2WH1Item	The order is rejected because none of the warehouses have sufficient quantities of the desired product.
	InsufficientStock2WH2Items	The order is rejected because none of the warehouses has sufficient stocks for any of the desired products.
<i>Test Group 2: ShipmentConfirmed</i>		<i>Tests where the shipment is done.</i>
Test Cases	PrimaryScenario	The warehouse has the desired item.
	ShipmentWithReplenishmentSufflnv	The warehouse has the desired item. Replenishment with sufficient inventory.
	ShipmentCannotReplenishInvalidOrder	The warehouse has the desired item. However, during replenishment, the order is judged invalid.
	ShipmentWithReplenishmentInsufflnv	The warehouse has the desired item. During replenishment, the inventory is insufficient and manufacturing gets involved.
	ShipmentByNextWarehouse	The first warehouse has insufficient stocks but the second one provides the shipment.
<i>Test Group 3: PeriodicReplenishment</i>		<i>Tests for the periodic replenishment architectural alternative.</i>
Test Cases	StopRightAway	The periodic replenishment is stopped right away.
	CheckButStocksSufficient	The periodic replenishment is checked but stocks are sufficient.
	CheckAndStockInsufficient	The periodic replenishment is checked and stocks need to be increased. The order is valid and the inventory is sufficient.
	CheckAndStockInventoryInsufficient	The periodic replenishment is checked and stocks need to be increased. The order is valid and the inventory is insufficient.
	CheckAndStockInsufficientInvalidOrder	The periodic replenishment is checked and stocks need to be increased. The order is however invalid (malformed, invalid product or invalid quantity).
<i>Test Group 4: ViewEvents</i>		<i>Scenarios for the viewing of the events log.</i>
	CanAccessLog	The request for viewing the events is valid and the relevant events are listed.
	CannotAccessLog	The request for viewing the events is invalid.
<i>Test Group 5: LogRequests</i>		<i>Scenarios checking the event log mechanism.</i>
Test Cases	EventLogged	Primary scenario where the event is logged.
	InvalidLogRequest	The event log request is invalid and denied.
	InvalidLogRequestNoRepo	The event log request is invalid. The system attempts to log the request but cannot because the repository is unavailable.
	ValidLogRequestNoRepo	The valid log request fails because the repository is unavailable.

**Table 8** Test cases for SCM (adapted from [38])

## 6.2. UCM Model for SCM

This case study takes advantage of the UCM model defined in [39] and adapts it to the UCM model for SCM, based on user requirements described in 6.1.1. The UCM model for SCM is created using our modified version of UCMNAV. Then it is exported as a DXL script by using the new feature of UCMNAV discussed in Chapter 3. The DXL script is interpreted and executed to create the UCM model for SCM in DOORS, using the DXL library discussed in Chapter 4. The initial UCM model for SCM in DOORS is shown (in part) in Figure 39 and Figure 40, whereas the complete model can be found in Appendix C.

Figure 39 shows the UCM maps for SCM, as seen from DOORS. On the left side, a tree-like explorer provides the view for the structure of the map module and for navigating to a specific object in the module. UCM map objects are shown in the right panel. They can be displayed in different views where we can customize different sorts, attributes, and filters for the displayed objects. The *Map* column shows diagrams for UCM maps as well as the names of the objects they contain. The *Type* column indicates the object types. For objects having links to/from objects in other modules, DOORS also provides the facility to display information about their traced objects. Thus, the *Referred Component* column is used to display the linked components from the core module for *compRef* objects in the maps module. In the same way, the column *Referred Responsibilities* displays names of the linked responsibilities from the core module.

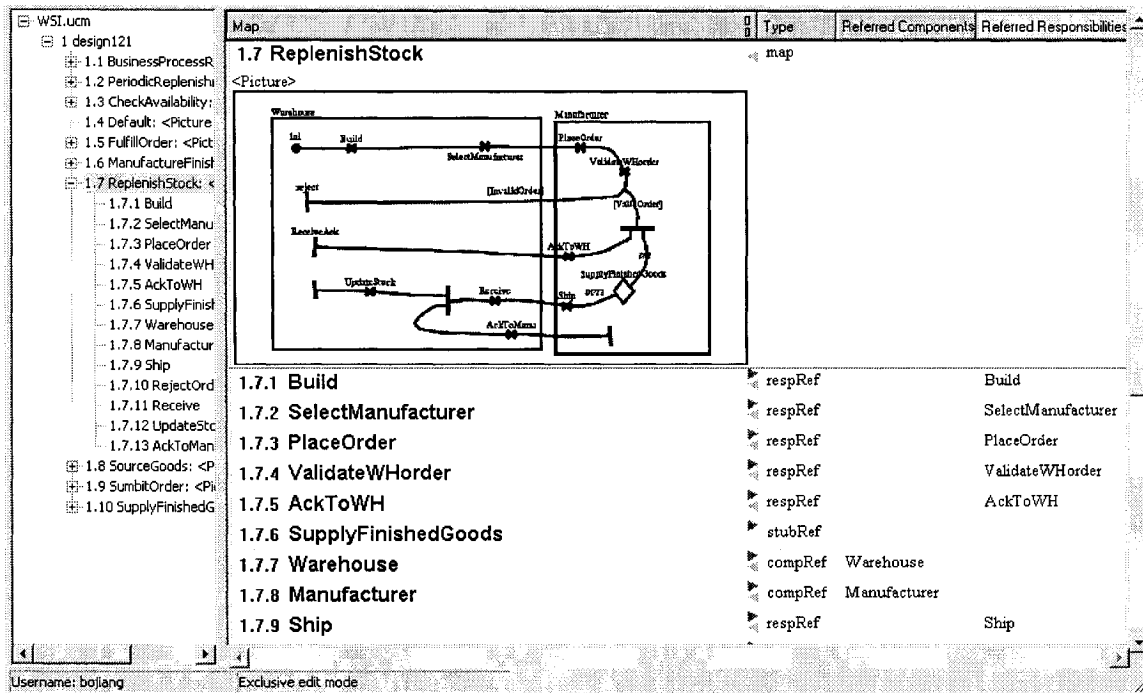

Figure 39 UCM maps for SCM

UCM scenarios for SCM are shown in Figure 40. As this is the initial UCM model for SCM, only internal links are created between UCM objects.

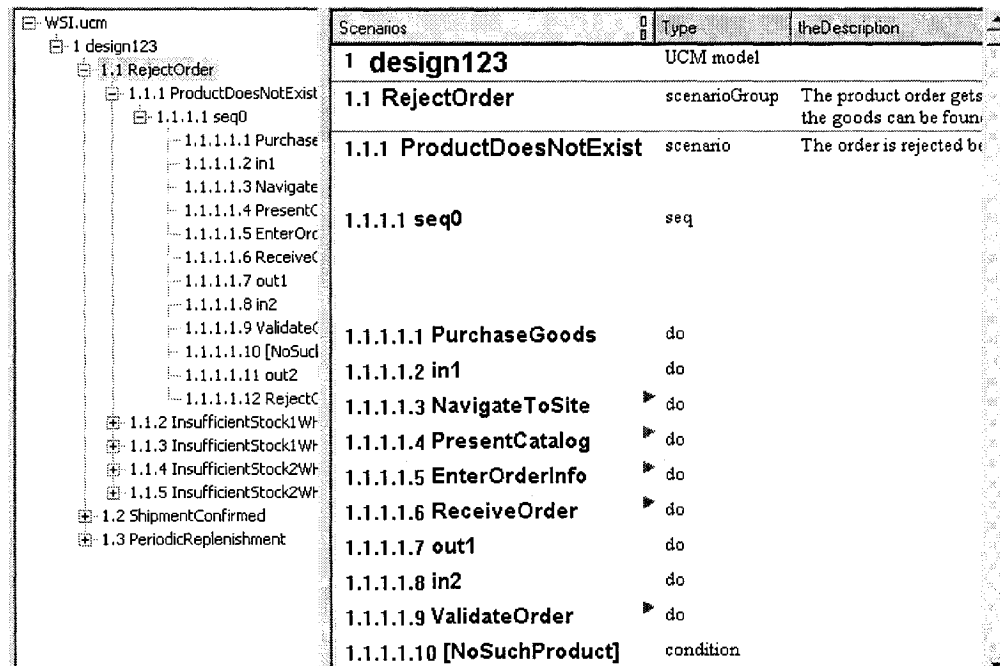

Figure 40 UCM scenarios for SCM

After being imported into DOORS, the UCM model elements need be linked *to* user requirements and *from* system requirements. In this case study, UCM maps and component reference under them are linked to the matching Use Case in the user requirements. Responsibility references are linked to concrete steps in a Use Case. Each piece of system requirements is linked to the corresponding responsibility reference in UCM maps.

By using the *traceability column* feature provided by DOORS, a traceability view can be used in the user requirements module to show relationships to UCM maps and, indirectly, to system requirements (Figure 41). For each user requirement, the traceability view shows the information about objects in UCM maps (column *UCM Requirements*) that are linked to it. In the same way, system requirements that link to UCM objects are shown in column *System Requirements*.

System Requirements	UCM Requirements	User Requirements	ID
	ReplenishStock <Picture> Warehouse	<b>5 Use Case 3: Replenish Stock</b> The Retailer System orders goods from a manufacturer to replenish stock for a particular product in a particular warehouse.	387
The warehouse should be able to build the order for a manufacturer.	Build	<b>5.1 The Retailer System constructs a purchase order for the product with the necessary quantity to bring the product up to its maximum level for that warehouse.</b>	386
The warehouse should be able to select the appropriate manufacturer. The warehouse should be able to place the order to the selected manufacturer.	SelectManufacturer PlaceOrder	<b>5.2 Place Order. The Retailer system submits the purchase order to the relevant Manufacturing System (Brand1, Brand2 or Brand3) as dictated by the product.</b>	390

Username: bojiang      Exclusive edit mode

**Figure 41** Traceability view from user requirements

The imported UCM scenarios are also linked from test cases in test requirements as shown in Figure 42. Column “*In-links from Test Cases*” indicates the test case or test group which describes the linked scenario or scenario group. Note that concrete scenario steps are hidden in the traceability view in Figure 42 by specifying a filter.

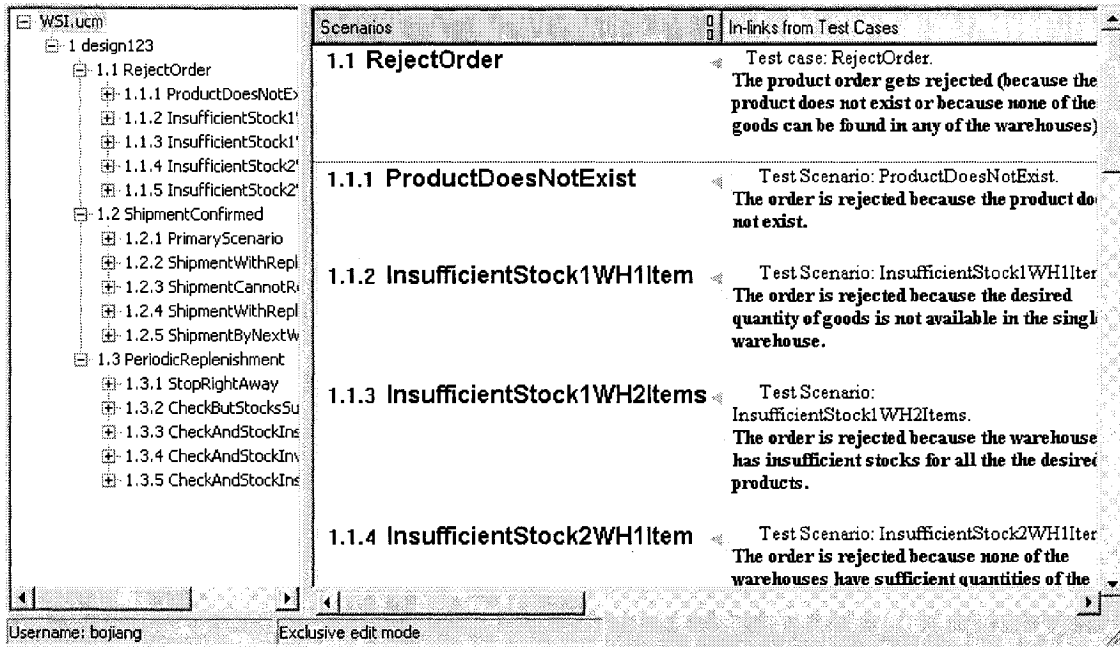

Figure 42 Scenarios traceability view

After creating links between the UCM model and external requirements, user requirements, system requirements, and test requirements of are connected through the UCM model with relations shown in Figure 35. By exploring links between them, the completeness and consistency of requirements can be checked. For instance, UCM maps can be validated against their linked use cases and system requirements, as shown in Figure 41, as well as UCM scenarios being validated against their linked test cases as shown in Figure 42.

Links can be used as filter conditions to find out isolated requirements. For example, in our first version of the UCM model, the map *periodic replenishment* and its objects have no links to user requirements. This is detected by applying the following filter condition to the map module: *Not (Has out-links through /WSI-link with reqts./maps/satisfies)*. This could become a reason to remove the map *periodic replenishment* in the next version of the UCM model. Also, the use cases “Log Events” and “View Events” from the user requirements have no support in the UCM model. This can be detected by applying the following filter condition: *Not (Has in-links through /WSI-link with reqts./maps/satisfies)*. This could justify the addition of new maps for these two use cases in the next version of the UCM model.

### 6.3. Managing Changes to the UCM Model

As we discussed in last section, validating the first version of the UCM model for SCM to other requirements may lead to the detection of incomplete UCM models and inconsistencies with other requirements. This (or other reasons) can be a start point for the next version of the UCM model. Once the UCM model is modified in UCMNAV, a new DXL script is generated to update the UCM model in DOORS. This section uses a new version of the UCM model for SCM to validate the update mechanism discussed in section 5.3.

The following changes in Table 9 are applied on the first UCM model for SCM to obtain the second version. They cover the addition, modification, and deletion of objects and attributes from the Core, Maps, and Scenarios packages in the metamodel.

	Core	Maps	Scenarios
<b>Add</b>	Responsibility: ValLogRequest LogToRepository LogInvalidRequest EnterCriteria ValidateRequest  Component: MonitoringSystem Administrator	LogEventsRoot (Map): ValLogRequest (respRef) LogToRepository (respRef) LogInvalidRequest (respRef) MonitoringSystem (compRef)  ViewEventsRoot(Map): EnterCriteria (respRef) ValidateRequest (respRef) MonitoringSystem (compRef) Administrator (compRef)	ViewEvents: CanAccessLog CannotAccessLog  LogRequests: EventLogged InvalidLogRequest InvalidLogRequestNoRepo ValidLogRequestNoRepo
<b>Modify</b>	Change speed factor of ConsumerProc (Device) from 2 to 1	ReplenishStock(Map): Move PlaceOrder (respRef) from Manufacturer (compRef) to Warehouse (compRef)  Rename Build(respRef) to BuildOrder and change description  Move ValidateWOrder(respRef) position within same component.  Move SelectManufacturer(respRef) position within same component.	Change the description of PrimaryScenario (Scenario) in ShipmentConfirmed (ScenarioGroup)
<b>Delete</b>	Responsibility: TEST-Timeout	PeriodicReplenishment (Map): TEST-Timeout (respRef) Replenishment (Stub) Warehouse (compRef)	PeriodicReplenishment: StopRightAway CheckButStocksSufficient CheckAndStockInsufficient CheckAndStockInventoryInsufficient CheckAndStockInsufficientInvalidOrder

**Table 9** Changes applied on the first UCM model for SCM

The rest of this section will present the new UCM model after applying the changes listed in Table 9, including its interactions with other requirements.

### 6.3.1 Addition of New Maps and Core Elements

As shown in Figure 43, maps *LogEventsRoot* and *ViewEventsRoot* were added into the map module for SCM, including responsibility references and component references under them. Referred components and responsibilities are also listed in traceability columns *New Components in core* and *New Responsibilities in core*. Only new objects in the map module are shown in Figure 43 by applying a filter to select objects having no links to/from external requirements.

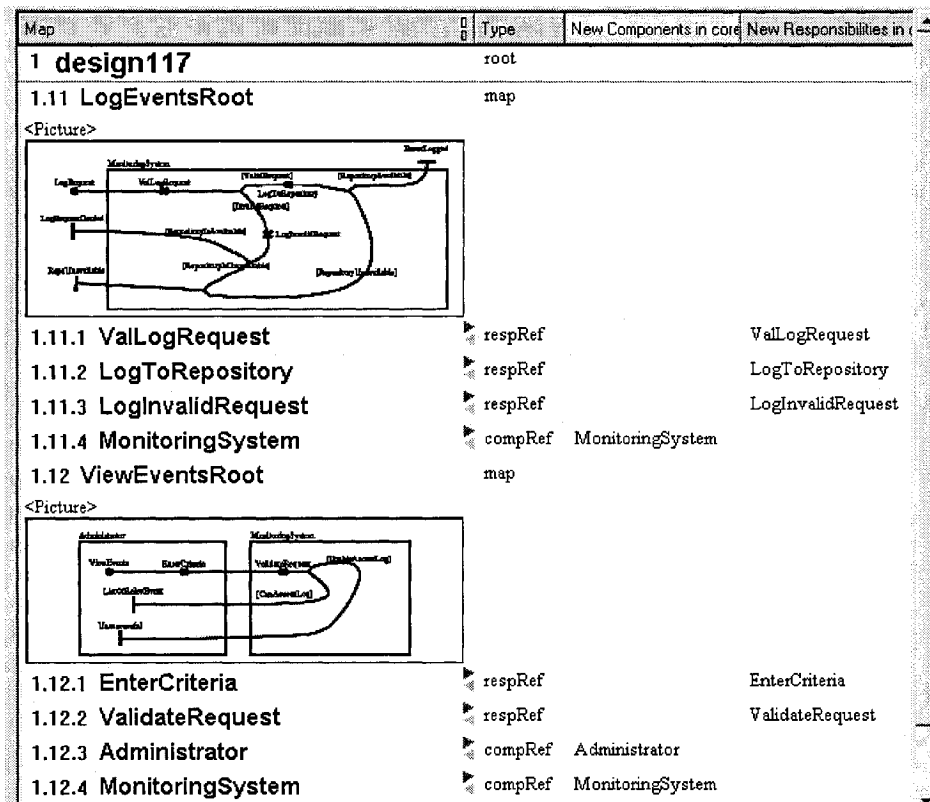
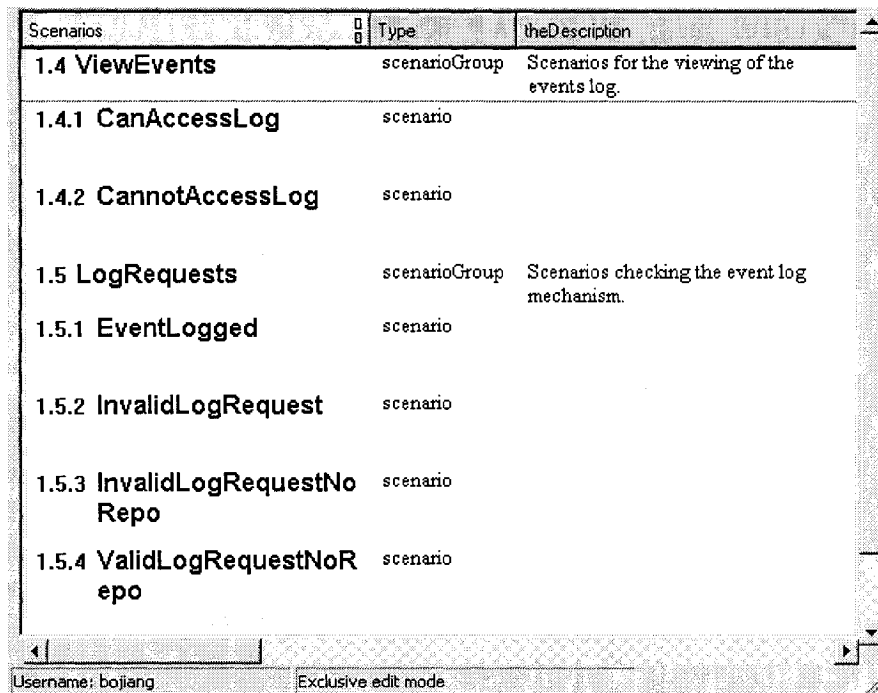

Figure 43 New maps and core elements

### 6.3.2 Addition of New Scenarios

New scenario groups and their scenarios were added to the scenario module in the UCM model for SCM, as shown in Figure 44. Scenarios with links from test requirements and

concrete steps of new scenarios are filtered out by defining a filter for the scenario module view. This provides a clear view focusing on new scenarios in the scenario module.



Scenarios	Type	theDescription
<b>1.4 ViewEvents</b>	scenarioGroup	Scenarios for the viewing of the events log.
1.4.1 CanAccessLog	scenario	
1.4.2 CannotAccessLog	scenario	
<b>1.5 LogRequests</b>	scenarioGroup	Scenarios checking the event log mechanism.
1.5.1 EventLogged	scenario	
1.5.2 InvalidLogRequest	scenario	
1.5.3 InvalidLogRequestNo Repo	scenario	
1.5.4 ValidLogRequestNoRepo	scenario	

Username: bojiang Exclusive edit mode

**Figure 44** New scenarios after the update

New UCM maps, core elements, and scenarios added into the UCM model are isolated with respect to other requirements. They have to be linked manually with external requirements. The traceability view in Figure 45 shows that new links were created from system requirements to use cases through the new UCM maps. Test requirements should also be linked to the new UCM scenarios.

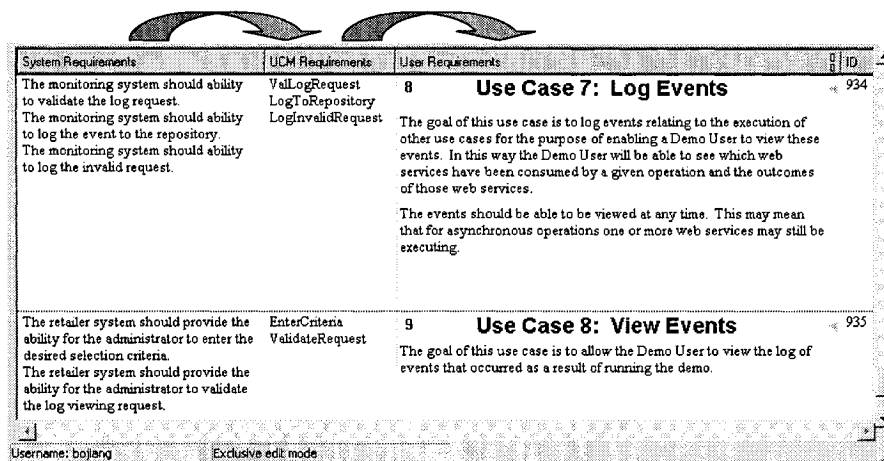

Figure 45 Adding links between new UCM maps to/from external requirements

### 6.3.3 Deletion of Maps

Map *PeriodicReplenishment* and its objects should be removed from the map module while importing the new version of the UCM model. However, exceptions were generated during the update process. A responsibility reference *TEST-Timeout* cannot be deleted by the update process because it has an incoming link from one system requirement, which indicates that this system requirement depends on it. Map *PeriodicReplenishment* also cannot be deleted because its child *TEST-Timeout* still exists. The update process of the UCM model reports these problems in an exception view, as shown in Figure 46. To remove these two objects in the report, the link between *TEST-Timeout* and system requirements needs to be manually removed first. Then *TEST-Timeout* and its parent map can be deleted, either manually or by re-executing the update process.

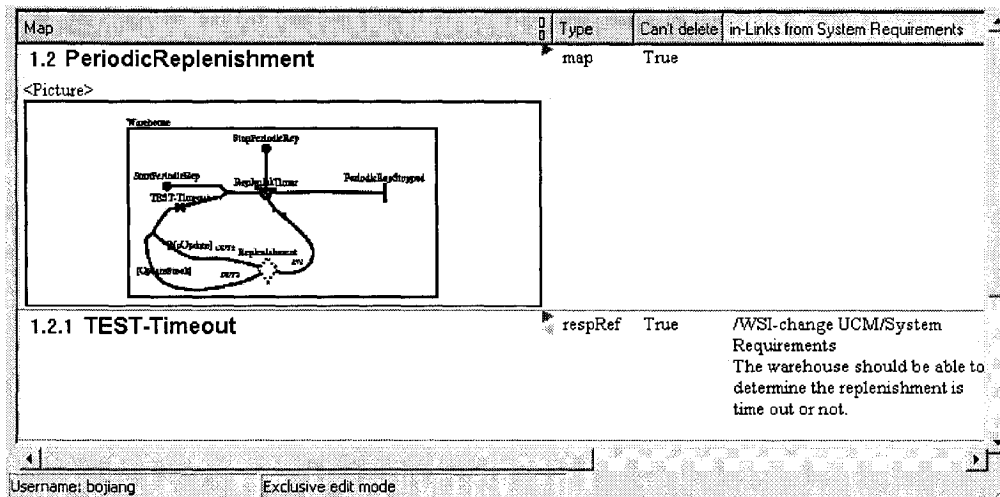

Figure 46 Exceptions generated while deleting maps

### 6.3.4 Deletion of Scenarios

In Figure 47, the scenario group *PeriodicReplenishment* and its contained scenarios are also reported as “Can’t delete” by the update function, as indicated by the column of the same name. They have incoming links from test cases in the test requirements. To remove them, links from the test requirements need to be removed first.

Scenarios	Type	Can't delete	in-links from Test requirements
1.3 PeriodicReplenishment	scenario Group	True	Scenarios for the periodic replenishment architectural alternative.
1.3.1 StopRightAway	scenario	True	The periodic replenishment is stopped before being performed even once.
1.3.2 CheckButStocksSufficient	scenario	True	The periodic replenishment is checked but stocks are sufficient.
1.3.3 CheckAndStockInsufficient	scenario	True	The periodic replenishment is checked and stocks need to be increased. The order is valid and the inventory is sufficient.
1.3.4 CheckAndStockInventory/Insufficient	scenario	True	The periodic replenishment is checked and stocks need to be increased. The order is valid and the inventory is insufficient.
1.3.5 CheckAndStockInsufficient InvalidOrder	scenario	True	The periodic replishment is checked and stocks need to be increased. The order is however invalid (malformed, invalid product or invalid quantity).

Figure 47 Exceptions generated while deleting scenarios

### 6.3.5 Modification to Maps

Although there are four changes, listed in Table 9, applied to the map *Replenish Stock*, not all of them will lead to suspect links in the user requirements. The later two changes do not trigger suspect links because they only change values of position attributes of objects under the map *Replenish Stock*. Position attributes are included in Table 3. The first two changes affect the meaning of responsibilities *Build* and *PlaceOrder* by modifying associations or attributes not included in Table 3. They cause related links to be suspected in the user requirements, as shown in Figure 48.

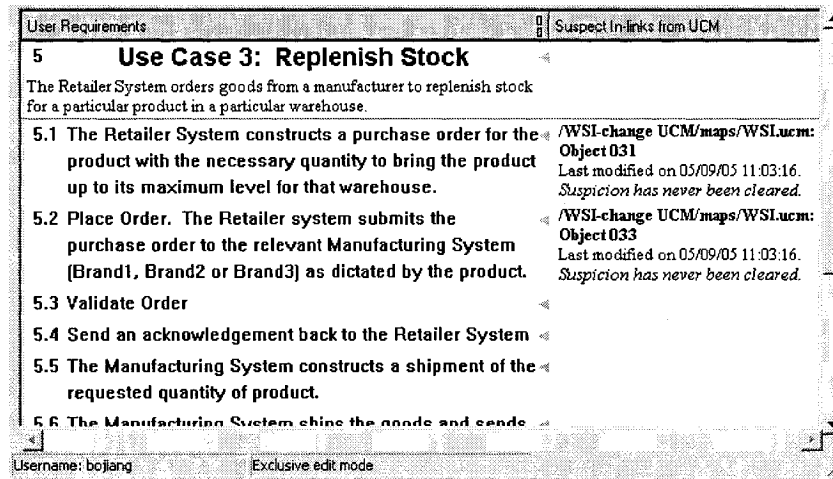

Figure 48 Triggering suspect links in user requirements

Since the two modified UCM objects, *Build* and *PlaceOrder*, also have links from system requirements, suspect out-links are triggered in related system requirements by their new definitions, as shown in Figure 49.

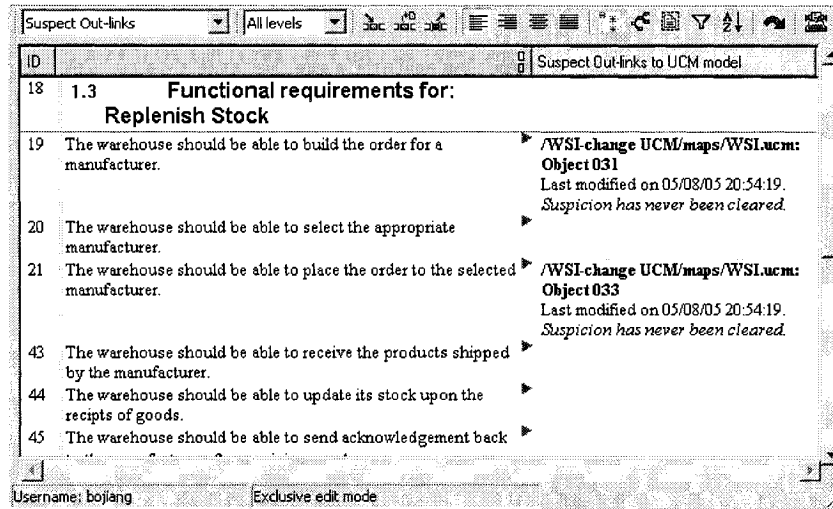

Figure 49 Triggering suspect out-links in system requirements

The modified UCM objects should be validated to their linked external requirements. The validation process may lead to further modifications of the UCM model or its linked external requirements, until everything is stable and consistent.

### 6.3.6 Modification to Scenarios

The new description of the scenario *PrimaryScenario* may have changed its meaning, hence causing two suspected links in their linked test scenarios, as shown in Figure 50. The test cases should be validated against the revised scenarios. Further modifications may be required from the UCM scenario or the test requirements, depending on the validation result.

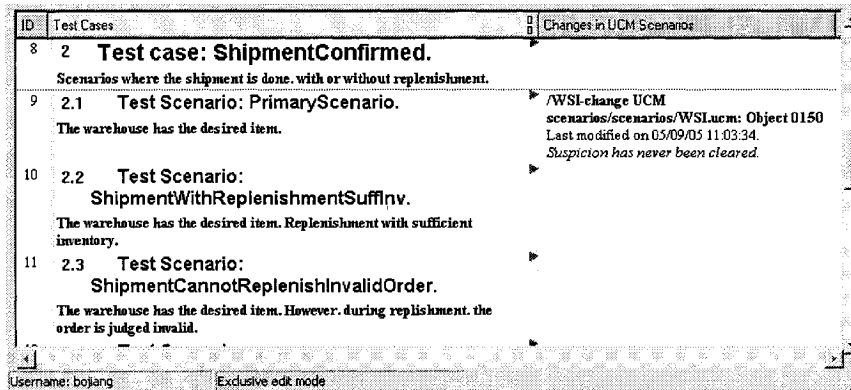

Figure 50 Triggering suspect out-links in test cases

## 6.4. Managing Changes to External Requirements

When external requirements are changed, their linked UCM model elements may be affected. Adding new external requirements often lead to the addition of corresponding UCM objects or scenarios. Removing part of system requirements and test requirements often make the linked UCM objects either irrelevant or unsupported at the lower level. User requirements cannot be deleted when they have links from the UCM model. The links between them and the UCM model should be cleared prior to removal. Such delete actions can make part of the UCM model having no links to user requirements, thus the latter may have no further reason to exist in the UCM model. Modifying external requirements will trigger the evolution of the UCM model. Our approach provides a DXL function that generates a report for changed requirements related to the UCM model, including their previous definitions. Figure 51 shows the report of changed requirements linked to/from the UCM model, including user requirements, system requirements, and test cases.

```
WSI
//changed requirements:
BuildOrder ( respRef h142 ) has suspect Inlinks
suspect Module:/WSI- change reqts./System Requirements  Object:19  Object Text  modifyObject
05/11/05 03:29:34
The warehouse should be able to build the order. -> The warehouse should be able to build the order
for a manufacturer.

ValidateWHorder ( respRef h147 ) has suspect Outlinks
suspect Module:/WSI- change reqts./User Requirements  Object:889  Object Heading  modifyObject
05/11/05 03:27:30
Check whether the order is valid or not. -> Validate the order placed by the warehouse is valid or not.

ProductDoesNotExist ( scenario scenarioGroup-RejectOrder_scenario-ProductDoesNotExist ) has
suspect Inlinks
suspect Module:/WSI- change reqts.//Test requirements  Object:3  Object Text  modifyObject
05/11/05 03:26:02
The order is rejected. -> The order is rejected because the product does not exist.
```

**Figure 51** Reporting changed requirements to UCMNAV

The report in Figure 51 can work as an effective way of triggering and guiding the evolution of the UCM models to adapt to changes in their related requirements.

## 6.5. Discussion

The case study presented in this chapter has illustrated the usage of a UCM model in combination with the DOORS RMS. It mainly shows the interaction between the UCM model and other requirements when one of them is changed. Keeping the traceability and consistency in requirements is one of the most important benefits of our approach.

### 6.5.1 Benefits and Limitations

The approach described in this thesis can bring interesting benefits to requirements engineers during requirements elicitation, validation, and management:

- *Introducing UCM into DOORS.* The Use Case Map notation can describe multiple visual scenarios in a single, integrated view. This promotes the understanding and reasoning about the system as a whole. Also a UCM model can collaborate well with other requirements, such as user requirements, system requirements and test requirements.
- *Integration of suitable tools.* Our approach defines a mechanism to import and update a UCM model from the best UCM tool currently available (UCMNAV) to a popular commercial RMS (DOORS). Each tool can be used to perform the tasks that they do the best. For instance, UCMNAV can be used to modify the UCM model efficiently, or to transform it to other representations.

The current approach also suffers from some limitations:

- *No direct modification of a UCM model in DOORS.* Any change to the UCM model needs to be performed in a tool separate from the RMS, which brings some inconveniences to requirements engineers.
- *Lack of support for more traceable UCM objects in the RMS.* More UCM objects should be added into RMS to express a UCM model more completely. For instance, adding more UCM-related performance concepts into the RMS would enable the UCM model to be more easily linked to non-functional performance requirements. However, the framework suggested in this thesis can easily be extended to support new types of objects and attributes from the UCM metamodel.

## 6.5.2 Comparison with Other Tools

### **Scenario Plus**

*Scenario Plus* is a plug-in for DOORS which was introduced in section 2.3.1. It enables requirement managers to create a wide variety of visual models within DOORS:

- *Use Case Diagrams*
- *Goal Models*
- *Domain Knowledge Models*
- *Entity Relationship Models*
- *DOORS-style Information Model Diagrams*
- *Graham-style Agent Interaction Models*
- *Yourdon-style Dataflow Diagrams*
- *Kilov-style Object Relationship Diagrams*
- *Decision Trees*
- *i\* Strategic Dependency Diagrams (for NFRs)*
- *Toulmin-style Argumentation Models*
- *Onion Models of Stakeholder Relationships*

This tool provides some advantages to the requirements manager in RMS. For instance, the above models and diagrams can be modified through the *Scenario Plus* plug-in in DOORS, without relying on external tools. Also, the elements used in these diagrams are traceable objects, which can be linked to/from other requirements. In this tool however, these diagrams and models cannot be exported to and imported from other tools, which would be more efficient to modify them and derive more useful information (e.g. design information) from them. The usability of the diagram editors is very limited, and the performances rather slow. It also does not support expressing UCM scenarios in DOORS.

### **DOORS/Analyst**

*DOORS/Analyst* is a plug-in for DOORS which was introduced in section 2.3.2. It enables users to visualize requirements using the following UML 2.0 diagrams:

- *Use Case Diagrams*
- *Sequence Diagrams*
- *Class Diagrams*

- *Flow Chart Diagrams*
- *State Chart Diagrams*
- *Architecture Diagrams*

These diagrams can be modified inside the RMS through *DOORS Analyst*, which provides a user interface with good performance and usability. Some specific elements in diagrams can be linked to/from other requirements. Therefore, traceability can be established between requirements and detail parts of these diagrams, in a way similar to our approach.

This tool can export UML diagrams inside DOORS to other professional modeling tools but it does not provide an import mechanism. UCMNAV can transform UCM models to a variety of other representations (MSC, sequence diagrams, LQN, etc.), and UCM models are meant to be importable to DOORS. Other limitations of this tool include the lack of support for UCM models for selecting which diagram elements should be transformed into linkable objects.

### ***Implementations***

DOORS/Analyst is not implemented in DXL. It is actually adapted from the UML diagram editor from *Telelogic Tau G2* (without the analysis or transformation capabilities found in Tau). DOORS/Analyst works as a separate executable program and uses the DOORS API to embed the diagrams created in DOORS/Analyst into the DOORS database. This implementation provides a professional diagram editor inside DOORS as well as excellent performance for integrating diagrams and traceable items. However, this implementation is tightly coupled and does not provide the user with flexible ways to change it (e.g., via a user-oriented API).

Scenario Plus implements a scenario diagram editor inside DOORS in DXL. Due to the limitation of DXL in diagram expression, the performance of the diagram editor is very limited.

Both plug-ins provide diagram editors inside DOORS, which are more convenient for users than our approach. However, the lack of flexibility of DOORS/Analyst and the limited DXL performance when drawing diagrams convinced us to give up the idea of an internal UCM editor. Instead, our approach uses a fully functional but external scenario

editor, UCMNAV, and focuses more on expressing scenarios into traceable requirements items.

### ***Complementary Usage***

It is worth mentioning that our tool can be seen as complementary to Scenario Plus and DOORS/Analyst. They can all cohabit within DOORS, and our tool brings a UCM perspective that is currently missing. This can also provide an opportunity to explore and exploit links between UCM models and other types of requirements and design models. Additionally, by having access to the UCMNAV TOOL, information other than just UCM scenarios (e.g., test goals, MSCs, and performance models), can be derived from the UCM model.

## **6.6. Chapter Summary**

Through a Supply Chain Management case study, we demonstrated that our approach is applicable to a realistic example, and beneficial. First, UCMs give a complementary system view, where visual scenarios are integrated, to requirements engineers and designers. Then, the RMS manages all requirements as a whole, including UCMs, using various links between them. The completeness of requirements can be checked by using the filter functions provided by the RMS. The consistency of requirements is preserved by verifying requirements that have suspect links. The case study also checked the correctness and robustness of the DXL library by covering all the creation, modification, and deletion functions on core, map, and scenario elements.

## Chapter 7. Conclusions

---

This chapter reviews the contributions of the thesis and discusses further work arising from several issues encountered along the way.

### 7.1. Contributions

This thesis presents an extensible framework used to combine scenarios and other requirements in a RMS. The key issue in this framework is introducing visual scenarios (UCMs) into a RMS (DOORS). Through the implementation of this key issue, this thesis makes three main contributions, with a fourth one that relates to the validation of the framework.

***Contribution 1: Abstraction of a UCM metamodel from various sources.***

Based on the draft ITU.T Z.152 [20] and the UCM scenario DTDs [7], the class diagram describing the current UCM metamodel was generated semi-automatically by using reverse-engineering tools. This UCM metamodel, created in collaboration with Y.X. Zeng, was valuable in conducting the improvements to UCMNAV accomplished in this thesis.

***Contribution 2: Addition of a DXL export mechanism in UCMNAV***

UCMNAV was extended with a new functionality to export Use Case Map models as DXL scripts which can be understood and executed by the target RMS tool, DOORS. Only a subset of the UCM model information is exported, which is defined and explained with a metamodel (see Chapter 3).

***Contribution 3: Development of an extensible import/update mechanism for UCM models in DOORS***

A DXL library was created for DOORS, which supports the creation and update of UCM model in DOORS using DXL scripts generated by UCMNAV (see Chapter 4 and Chapter

5). The update of UCM models in DOORS may cause interactions with other requirements, at a higher level (user requirements) or at a lower level (system or test requirements). Change analysis is provided with various filters and views when the UCM model is updated or external requirements are changed.

***Contribution 4: Illustrative experiment on the interactive and iterative evolution of UCM models and other requirements***

A case study was produced to validate our framework. The framework is applied on a Supply Chain Management system. The case study demonstrates that UCMs and other requirements can be checked for consistency and completeness, even as they evolve over time (Chapter 6).

## **7.2. Future work**

Although we have made a number of significant achievements, our framework can be further improved. Suggestions for future work include:

***Introduce other relevant UCM elements into the RMS***

When using UCMs for high-level design, many UCM elements other than those in our metamodel could be imported into the RMS as traceable objects. For instance, UCM timestamp points and response-time requirements could be important to express performance requirements. The framework could easily be extended to support such elements, if they are proved to be relevant.

***Export UCM related requirements from DOORS to UCMNav***

In the current approach, the link from DOORS to UCMNAV is somewhat weak. Only changes to UCM-related requirements are exported in a textual report. The export process could be enhanced by exporting all UCM-related requirements from DOORS to UCMNAV and saving them as properties of the corresponding UCM elements in UCMNAV. To achieve this goal, the current requirements report mechanism needs to be improved to include all UCM related requirements in the report. Furthermore, UCMNav should be improved to understand these requirements properties and enable their usage

for traceability and navigation (e.g., via pop-up menus accessible from UCM elements, à la DOORS).

***Link UCM elements with other types of requirements***

In our case study, UCMs act as a bridge linking user requirements, system requirements, and tests. Obviously, UCMs could be used at a lower level of abstraction. More detailed UCM models could be used to refine system requirements as we move towards software requirements, component-based system requirements, and detail design specification. We believe that the framework is generic enough to support such application, but this remains to be verified.

***Integration with other tools, especially DOORS plug-ins***

As discussed in section 6.5.2, our tool could be used in collaboration with complementary DOORS plug-in such as DOORS/Analyst and Scenario Plus. The feasibility and usefulness of such combination deserves further exploration.

## References

---

- [1] Alexander, I.: *Scenario Plus - Tools for Requirements Engineering*. <http://www.scenarioplus.org.uk>. Accessed March 2004.
- [2] Amyot, D.: Introduction to the User Requirements Notation: Learning by Example. In: *Computer Networks*, 42(3), 285-301, 21 June 2003.
- [3] Amyot, D. and Andrade, R.: Description of Wireless Intelligent Network Services with Use Case Maps. In: *SBRC'99, 17<sup>th</sup> Simpósio Brasileiro de Redes de Computadores*, Salvador, Brazil, May 1999, 418-433.
- [4] Amyot, D. and Eberlein, A.: An Evaluation of Scenario Notations and Construction Approaches for Telecommunication Systems Development. In: *Telecommunications Systems Journal*, 24:1, September 2003, 61-94.
- [5] Amyot, D., Echihabi, A., He, Y.: UCMEXPORTER: Supporting Scenario Transformations from Use Case Maps. In: *NOuvelles TEchnnologies de la RÉpartition (NOTERE'04)*, Saïdia, Morocco, June 2004, 390-405. <http://ucmexporter.sourceforge.net>
- [6] Amyot, D. and Mussbacher, G.: Bridging the Requirements/Design Gap in Dynamic Systems with Use Case Maps (UCMs). Tutorial in: *23rd International Conference on Software Engineering (ICSE'01)*, Toronto, Canada, May 2001. <http://www.UseCaseMaps.org/pub/icse01.pdf>
- [7] Amyot, D., He, X., He, Y. and Cho, D.Y.: Generating Scenarios from Use Case Map Specifications. In: *Third International Conference on Quality Software (QSIC'03)*, Dallas, November 2003, 108-115.
- [8] Amyot, D. and Logrippo, L.: Use Case Maps and LOTOS for the Prototyping and Validation of a Mobile Group Call System. In: *Computer Communication*, 23(12), 2000, 1135-1157.
- [9] Amyot, D., Roy, J.-F., and Weiss, M.: UCM-Driven Testing of Web Applications. In: A. Prinz, R. Reed, and J. Reed (Eds.) *12th SDL Forum (SDL 2005)*, Grimstad, Norway, June 2005. LNCS 3530, Springer, 247-264.
- [10] Andrade, R.: Applying Use Case Maps and Formal Methods to the Development of Wireless Mobile ATM Networks. In: *Lfm2000: The Fifth NASA Langley Formal Methods Workshop*, Williamsburg, Virginia, USA, June 2000.
- [11] Breitman K. and Leite J.C.S.P.: Scenario Evolution: A Closer View on Relationships. In: *Proc. of the Fourth Intl Conf. on Requirements Engineering (ICRE 2000)*, Schaumburg, USA, 2000, 95-105.
- [12] Buhr, R.J.A. and R. S. Casselman: *Use Case Maps for Object-Oriented systems*. Prentice-Hall, 1996.

- [13] Buhr, R.J.A.: Use Case Maps as Architectural Entities for Complex Systems. In: *IEEE Trans. on Software Engineering*, Vol. 24, No. 12, Dec. 1998, 1131-1155.
- [14] Elammari, M. and Lalonde, W.: An Agent-Oriented Methodology: High-Level and Intermediate Models. In: *Proc. of the 1st Int. Workshop. on Agent-Oriented Information Systems (AOIS'99)*, Heidelberg, Germany, June 1999.
- [15] *Ghostscript, Ghostview and GSview*. <http://www.cs.wisc.edu/~ghost/>. Accessed May 2005.
- [16] Hamou-Lhadj, A., Braun, E., Amyot, D., and Lethbridge, T.: Recovering Behavioral Design Models from Execution Traces. *9<sup>th</sup> European Conference on Software Maintenance and Reengineering (CSMR)*, Manchester, UK, March 2005. IEEE Computer Society, 112-121.
- [17] He, Y., Amyot, D., and Williams, A.: Synthesizing SDL from Use Case Maps: An Experiment. In: *11th SDL Forum (SDL'03)*, Stuttgart, Germany, July 2003. LNCS 2708, 117-136.
- [18] IBM, *Rational Rose Enterprise Edition 2003*, <http://www-306.ibm.com/software/awdtools/developer/rose/>. Accessed April 2005.
- [19] ITU-T: Recommendation Z.150, User Requirements Notation (URN) – Language Requirements and Framework. Geneva, Switzerland, 2003.
- [20] ITU-T, URN Focus Group: *Draft Rec. Z.152 – UCM: Use Case Map Notation (UCM)*. Geneva, Switzerland, Sept. 2003. <http://www.UseCaseMaps.org/urn/>
- [21] Jarke M., Bui X.T., and Carroll J.M.: Scenario Management: An Interdisciplinary Approach. In: *Requirements Engineering*, 3(3/4), 1998, 155-173.
- [22] Lamsweerde A.v.: Requirements Engineering in the Year 00: A Research Perspective. In: *Proc. of 22nd Intl Conference on Software Engineering (ICSE)*. Limerick, Ireland, ACM press, 2000, 5-19.
- [23] *Layered Queueing Resource Page*. <http://www.layeredqueues.org/>. Accessed May 2004.
- [24] Miga, A.: *Application of Use Case Maps to System Design with Tool Support*. M.Eng. thesis, Dept. of Systems and Computer Engineering, Carleton University, Ottawa. October 1998. <http://www.UseCaseMaps.org/tools/ucmnav/>
- [25] Nuseibeh B. and Easterbrook S.: Requirements Engineering: A Roadmap. In: A. Finkelstein (Ed), *The Future of Software Engineering*, ICSE 2000, ACM Press, 2000, 35-46.
- [26] Object Management Group, *UML 2.0 Superstructure Specification*, OMG Adopted Specification, April 30, 2004.
- [27] Petriu, D.B.: *Layered Software Performance Models Constructed from Use Case Map Specifications*. M.Eng. thesis, Dept. of Systems and Computer Engineering, Carleton University, Ottawa, Canada, May 2001.

- [28] Petriu, D.B., Amyot, D., and Woodside, M.: Scenario-Based Performance Engineering with UCMNAV. In: *11th SDL Forum (SDL'03)*, Stuttgart, Germany, July 2003. LNCS 2708, 18-35.
- [29] Petriu, D.B., Amyot, D., Woodside, M, and Jiang, B.: Traceability and Evaluation in Scenario Analysis by Use Case Maps. To appear in: S. Leue and T. Systä (Eds.) *Scenarios: Models, Algorithms and Tools*, LNCS 3466, Springer, 2005.
- [30] SpeedDev Inc., *From Requirements Gathering to Product Release*, <http://www.speedev.com/requirements-management.htm>, accessed May 2005.
- [31] Telelogic AB, *DOORS/Analyst*, <http://www.telelogic.com/products/doorsers/>. Accessed May 2004.
- [32] Telelogic AB, *DOORS/ERS*, <http://www.telelogic.com/products/doorsers/>. Accessed May 2004.
- [33] Telelogic AB: *DXL Reference Manual of DOORS 7.0*, 2004.
- [34] UCM User Group: *Use Case Maps Navigator 2 (UCMNAV)*, <http://www.usecasemaps.org/tools/ucmnav/index.shtml>. Accessed April 2005.
- [35] UCM User Group: *UCMNAV XML DTD*, version 0.23, November 2001 <http://www.usecasemaps.org/xml/dtdindex.html>.
- [36] WS-I – Web Services Interoperability Organization: *Supply Chain Management: Use Case Model*, Version 1.0, 2003. <http://www.ws-i.org>
- [37] WS-I – Web Services Interoperability Organization: *Supply Chain Management: Sample Application Architecture*, Version 1.0.1, 2003. <http://www.ws-i.org>
- [38] Weiss, M. and Amyot, D.: Designing and Evolving Business Models with URN. *Montreal Conference on eTechnologies (MCeTech)*, Montréal, Canada, January 2005, 149-162.
- [39] Weiss, M. and Amyot, D.: Business Process Modeling with URN. In: *International Journal of E-Business Research*, 1(3), 63-90, July-September 2005.
- [40] Yi, Z.: *CNAP Specification and Validation: A Design Methodology Using LOTOS and UCM*. M.C.S. thesis, SITE, University of Ottawa, Canada, 2000.
- [41] Zeng, Y.X.: *Transforming Use Case Maps to the Core Scenario Model Representation*. M.C.S. thesis, SITE, University of Ottawa, Canada, 2005.

# Appendix A: System Requirements of SCM

---

## Retailer System

<b>Functional requirements for <i>Purchase Goods</i>:</b>	
	The retailer system should provide the ability for the consumer to navigate the Web site.
	The retailer system should presents its catalogue to the consumer
	The retailer system should provide the ability for the consumer to input the order information
	The retailer system should receive an order from the consumer that contains a list of items
	The retailer system should generate the list of items shipped.
	The retailer system should validate the order by checking that the requested products exist.
<b>Functional requirements for <i>Source Goods</i>:</b>	
	The retailer system should present list of requested items to the first warehouse
	The retailer system should present remaining list of requested items to the next warehouse.
	The retailer system should present records the items shipped.
	The retailer system should provide the ability for the warehouse to get the next item requested in the list of goods.
	The retailer system should provide the ability for the warehouse to decrements the stocks by the requested quantity.
	The retailer system should provide the ability for the warehouse to ship the requested items to the consumer.
	The retailer system should provide the ability for the warehouse to test whether there are more items requested.
	The retailer system should allow the second warehouse to have sufficient stocks if desired.
<b>Functional requirements for <i>Replenish Stock</i>:</b>	
	The warehouse should be able to build the order for a manufacturer.
	The warehouse should be able to select the appropriate manufacturer.
	The warehouse should be able to place the order to the selected manufacturer.
	The warehouse should be able to receive the products shipped by the manufacturer.
	The warehouse should be able to update its stock upon the receipts of goods.
	The warehouse should be able to send acknowledgement back to the manufacturer after receiving goods.
	The warehouse should be able to determine whether the replenishment has timed out.

## Manufacturing System

<b>Functional requirements for <i>Supply Finished Goods</i>:</b>	
	The manufacturer should be able to reject an order either due to a malformed order or a request for an invalid quantity.
	The manufacturer should be able to ship goods to the warehouse.
	The manufacturer should be able to validate an order received from a warehouse.
	The manufacturer should be able to send acknowledgement to a warehouse.
	The manufacturer should check the inventory for the requested product.
	The manufacturer should ship the products for the order from the warehouse.
	The manufacturer should update its inventory after shipping products.
<b>Functional requirements for <i>Manufacture Finished Goods</i>:</b>	
	The manufacturer should have the ability to determine the parts (and their quantities) required to produce the finished product.
	The manufacturer should have the ability to produce the requested product.
	The manufacturer should have the ability to stack finished goods in (manufacturer's) warehouse.

## Appendix B: Sample API Function in DXL

---

The following function is meant to illustrate the details of one function of the DOORS API for UCM import, in order to give an idea of the complexity of this API. The *responsibility* function (discussed in section 4.2.1) is used to create or update one responsibility object in the responsibility module. Responsibility attributes are specified by parameters. “responsibilityID” is a key attribute whose value is unique. In the beginning of the function, we try to open a responsibility module in edit mode. If this fails, an error message is displayed. If this is successful, the function scans all responsibilities in this module to find out the responsibility specified by the key “responsibilityID”. If the responsibility exists in the module, all its attributes are verified according to the values passed through the parameters of this function. Any new value of the responsibility’s attributes will be updated. Notice that its pre-treated attribute “Deleted” is restored to false. If the specified responsibility is not found in the module, then it is created with the attributes specified by the function parameters in the invocation.

```
bool responsibility (string responsibilityID,
                   string responsibilityName,
                   string theDescription,
                   string processorDemand)
{
    Object currentObject
    bool hasFound
    string tempString
    Module respModule=edit("Responsibility Module",false)

    if(!(null respModule)){
        hasFound=false
        for currentObject in respModule do{
            tempString=currentObject."ID"
            if (tempString==responsibilityID){
                hasFound=true
                tempString=currentObject."NameOfResponsibility"
                if(tempString!=responsibilityName){
                    currentObject."NameOfResponsibility"=responsibilityName
                    currentObject."Object Heading"=responsibilityName
                }
                tempString=currentObject."Processor Demand"
```

```

        if(tempString!=processorDemand){
            currentObject."Processor Demand"=processorDemand
        }
        tempString=currentObject."theDescription"
        if(tempString!=theDescription){
            currentObject."theDescription"=theDescription
        }
        currentObject."Deleted"=false
    }
}
if (!hasFound){
    int i=0
    for currentObject in respModule do{
        i++
    }
    if (i==0){
        currentObject=create respModule
    }
    else{
        currentObject=create currentObject
    }
    currentObject."Object Heading"=responsibilityName
    currentObject."ID"=responsibilityID
    currentObject."NameOfResponsibility"=responsibilityName
    currentObject."Processor Demand"=processorDemand
    currentObject."theDescription"=theDescription
    currentObject."Deleted"=false
}
}
else {
    errorBox("Responsibility module does not exist")
}
return true
}

```

## **Appendix C: UCM Model for the Supply Chain Management**

---

This is the first version of the UCM model used in the case study. The model content, generated as a UCMNAV report, is presented in the following pages.

**Design Description**

UCM model of the warehouse example from the Web Service Interoperability (WS-I) specification.

**BusinessProcessRoot**

**Root Map**

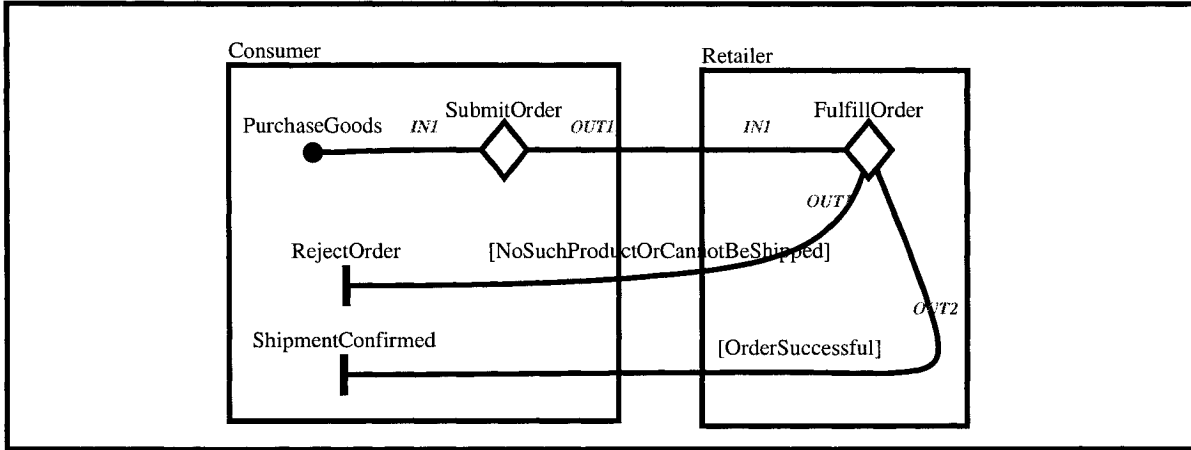

WS-I example

**Map Elements**

**Start Point - PurchaseGoods**

Description  
Initiates the process of purchasing desired goods.

**End Point - RejectOrder**

Description  
The order has been rejected.

**End Point - ShipmentConfirmed**

Description  
The order (or part thereof) has been accepted, and a detailed confirmation of the shipment is provided.

**Stubs**

**Static Stub - FulfillOrder**

Plugin Map - FulfillOrder

Input Bindings  
IN1 <-> in2  
Output Bindings  
OUT1 <-> out2  
OUT2 <-> out3

**Static Stub - SubmitOrder**

Plugin Map - SubmitOrder

Input Bindings  
IN1 <-> in1  
Output Bindings  
OUT1 <-> out1

**PeriodicReplenishment**

**Root Map**

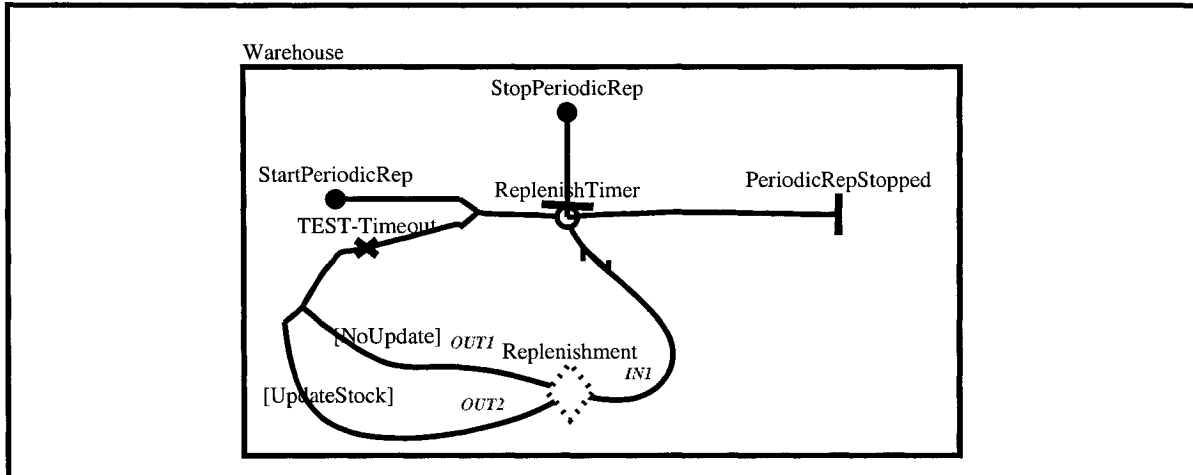

**PERIODIC REPLENISHMENT**

**Map Description**

This map presents an architectural alternative in which the replenishment is not triggered by decreasing stocks but is performed periodically.

**Responsibilities**

**TEST-Timeout**

Description

Dummy responsibility that make sure the timer will not time out again. Used in order to avoid endless loops in the UCMNav path traversal.

Variable Operations

ReplenishTimer\_timeout -> F

**Map Elements**

**Start Point - StartPeriodicRep**

Description

Start the periodic replenishment process.

**Start Point - StopPeriodicRep**

Description

Stop the periodic replenishment process.

**End Point - PeriodicRepStopped**

Description

The periodic replenishment process is stopped.

**Stubs**

**Dynamic Stub - Replenishment**

Plugin Map - Default

Selection Condition

SufficientStock

Input Bindings  
**IN1 <-> in1**  
 Output Bindings  
**OUT1 <-> out1**  
 Plugin Map - **ReplenishStock**  
 Selection Condition  
 !SufficientStock  
  
 Input Bindings  
**IN1 <-> in1**  
 Output Bindings  
**OUT1 <-> reject**

**CheckAvailability**

**Plugin Map**

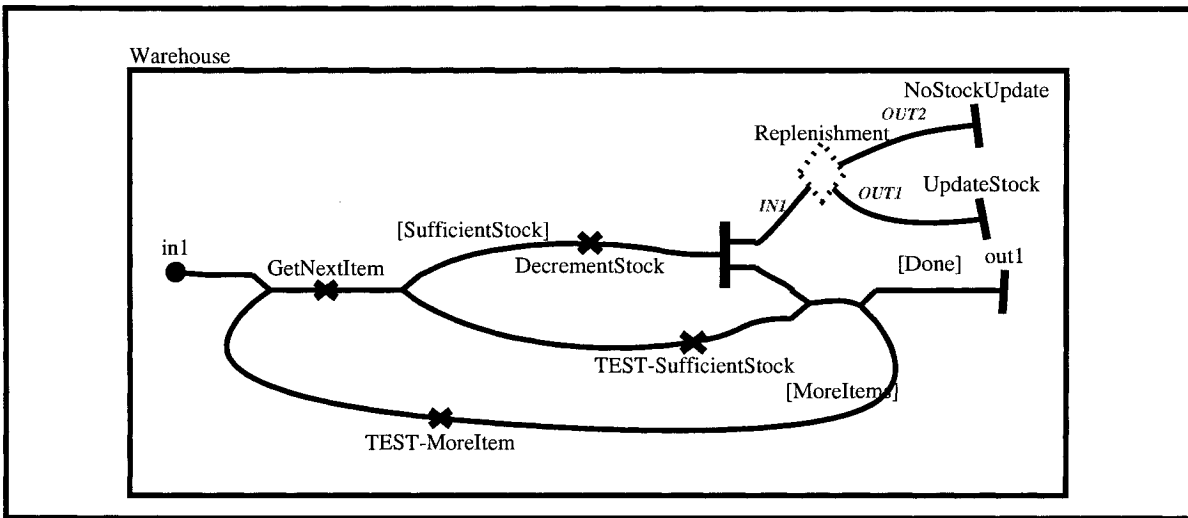

**CHECK AVAILABILITY**

**Parent Map Listing**

Plugin Map - SourceGoods Stub - CheckAvailability

**Responsibilities**

**DecrementStock**

Description

Decrements the stocks by the requested quantity. Some items can hence be shipped. For simulation purpose, the sufficiency of the stock is re-evaluated.

Variable Operations

**SomeItemsShipped -> T SufficientStock -> EVAL(StockStillSufficient)**

**GetNextItem**

Description

Get the next item requested in the list of goods.

**TEST-MoreItem**

Description

## UCM Navigator - WSI

---

Dummy responsibility that ensures that there will be no more items requested (hence limiting the number of iterations to 1 in that loop).

Variable Operations

**MoreItems -> F**

### TEST-SufficientStock

Description

Dummy responsibility that allows the second warehouse to have sufficient stocks if desired. Used for simulation purpose with UCMNav scenario traversals.

Variable Operations

**SufficientStock -> EVAL(StockStillSufficient)**

## Map Elements

---

### End Point - UpdateStock

Description

Stocks are updated.

### End Point - NoStockUpdate

Description

Stocks are not updated.

Or Fork -

Output Path 1

Selection Condition

**!MoreItems**

Probability

1.000000

Output Path 2

Selection Condition

**MoreItems**

Probability

1.000000

Or Fork -

Output Path 1

Selection Condition

**SufficientStock**

Probability

1.000000

Output Path 2

Selection Condition

**!SufficientStock**

Probability

1.000000

## Stubs

---

### Dynamic Stub - Replenishment

Plugin Map - **ReplenishStock**

Selection Condition

**!SufficientStock**

Input Bindings

**IN1 <-> in1**

Output Bindings

**OUT2 <-> reject**

Plugin Map - **Default**

Selection Condition

**SufficientStock**

**UCM Navigator - WSI**

Input Bindings

IN1 <-> in1

Output Bindings

OUT1 <-> out1

**Default**

**Plugin Map**

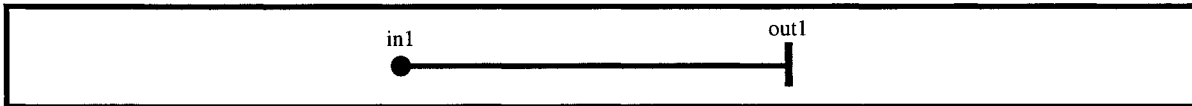

**DEFAULT - DO NOTHING**

**Parent Map Listing**

Plugin Map - CheckAvailability Stub - Replenishment  
Root Map - PeriodicReplenishment Stub - Replenishment  
Plugin Map - SupplyFinishedGoods Stub - ManufactureFinishedGoods

**FulfillOrder**

**Plugin Map**

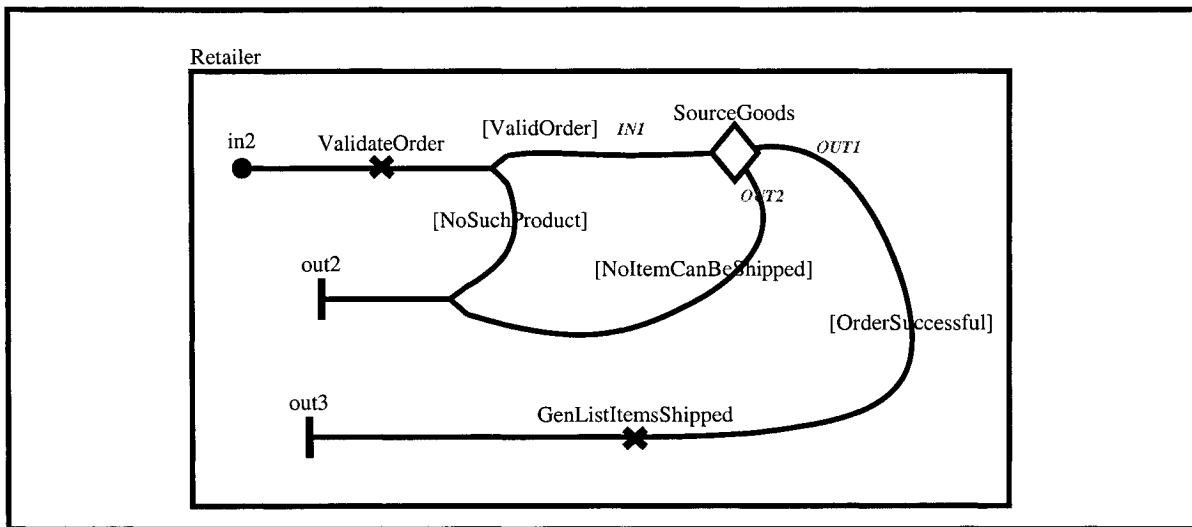

**FULFILL ORDER**

**Parent Map Listing**

Root Map - BusinessProcessRoot Stub - FulfillOrder

## UCM Navigator - WSI

### Responsibilities

#### GenListItemsShipped

Description

Generates the list of items shipped.

#### ValidateOrder

Description

Validate the order by checking that the requested products exist. For simulation purpose, initializes a variable that indicates that no item is shipped at this point.

Variable Operations

**SomeItemsShipped -> F**

### Map Elements

Or Fork -

Output Path 1

Selection Condition

ProductExists

Probability

1.000000

Output Path 2

Selection Condition

!ProductExists

Probability

1.000000

### Stubs

Static Stub - **SourceGoods**

Plugin Map - **SourceGoods**

Input Bindings

**IN1 <-> in1**

Output Bindings

**OUT1 <-> out1**

**OUT2 <-> out2**

## ManufactureFinishedGoods

## Plugin Map

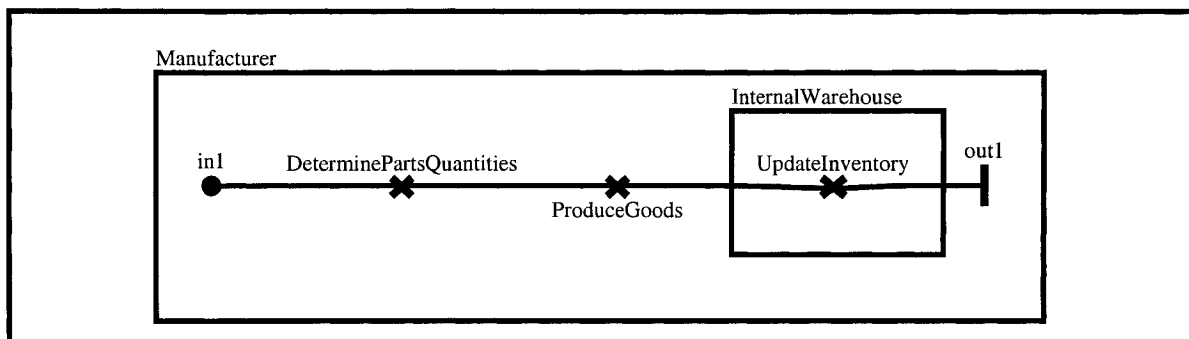

## MANUFACTURE FINISHED GOODS



## UCM Navigator - WSI

---

### Parent Map Listing

---

Plugin Map - **CheckAvailability** Stub - **Replenishment**  
Root Map - **PeriodicReplenishment** Stub - **Replenishment**

### Responsibilities

---

#### AckToManu

#### AckToWH

Description  
Send a acknowledgement back to the Retailer system

#### Build

Description  
Build the order for a manufacturer

#### PlaceOrder

Description  
Place the order to the selected manufacturer.

#### Receive

#### SelectManufacturer

Description  
Select the appropriate manufacturer.

#### Ship

Description  
Shipe goods and the notice

#### UpdateStock

#### ValidateWHorder

Description  
Validate an order received from a warehouse

### Map Elements

---

#### End Point - **ReceiveAck**

Description  
Partial acknowledgment indicating that the request is being processed.

#### Or Fork -

#### Output Path 1

Selection Condition  
!ValidOrder  
Probability  
1.000000

#### Output Path 2

Selection Condition  
ValidOrder  
Probability  
1.000000

**Stubs**

Static Stub - **SupplyFinishedGoods**  
Plugin Map - **SupplyFinishedGoods**

Input Bindings  
    **IN1** <-> **in1**  
Output Bindings  
    **OUT1** <-> **out1**

**SourceGoods**

**Plugin Map**

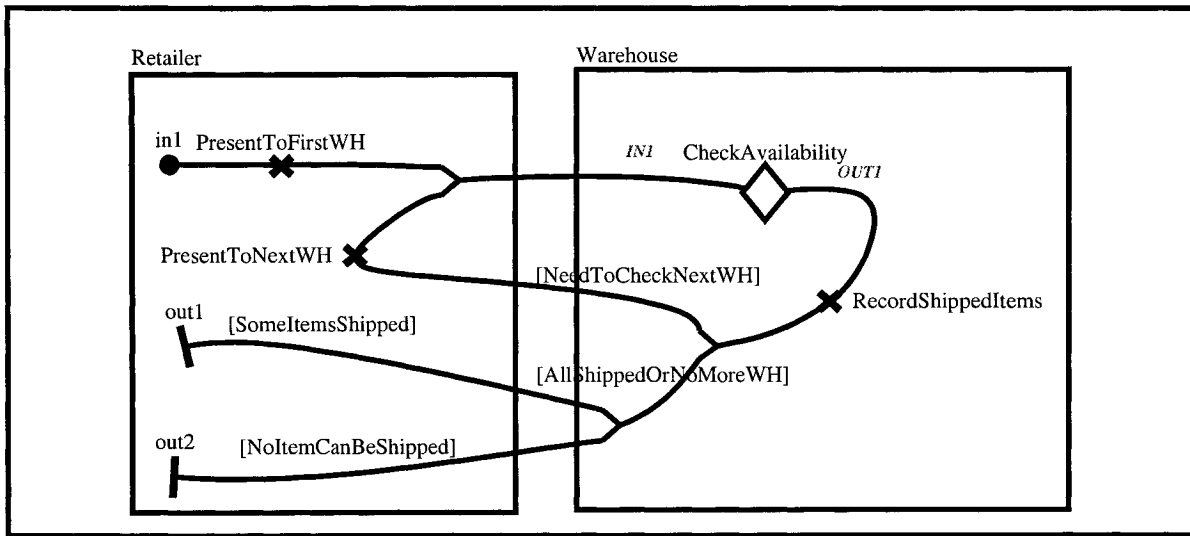

**SOURCE GOODS**

**Parent Map Listing**

Plugin Map - **FulfillOrder** Stub - **SourceGoods**

**Responsibilities**

**PresentToFirstWH**

Description  
Present list of items to the first warehouse

**PresentToNextWH**

Description  
Present remaining list of items to the next warehouse. For simulation purpose, ensures that there are at most 2 warehouses, hence limiting the number of iterations to one in that loop.

Variable Operations  
**WarehouseLeft** -> **F**

**RecordShippedItems**

Description  
Records the items shipped.

## UCM Navigator - WSI

### Map Elements

---

Or Fork -

Output Path 1

Selection Condition  
SomeItemsShipped  
Probability  
1.000000

Output Path 2

Selection Condition  
!SomeItemsShipped  
Probability  
1.000000

Or Fork -

Output Path 1

Selection Condition  
WarehouseLeft & (!ItemListEmpty)  
Probability  
1.000000

Output Path 2

Selection Condition  
(!WarehouseLeft) + ItemListEmpty  
Probability  
1.000000

### Stubs

---

Static Stub - CheckAvailability

Plugin Map - CheckAvailability

Input Bindings

IN1 <-> in1

Output Bindings

OUT1 <-> out1

---

---

## SubmitOrder

## Plugin Map

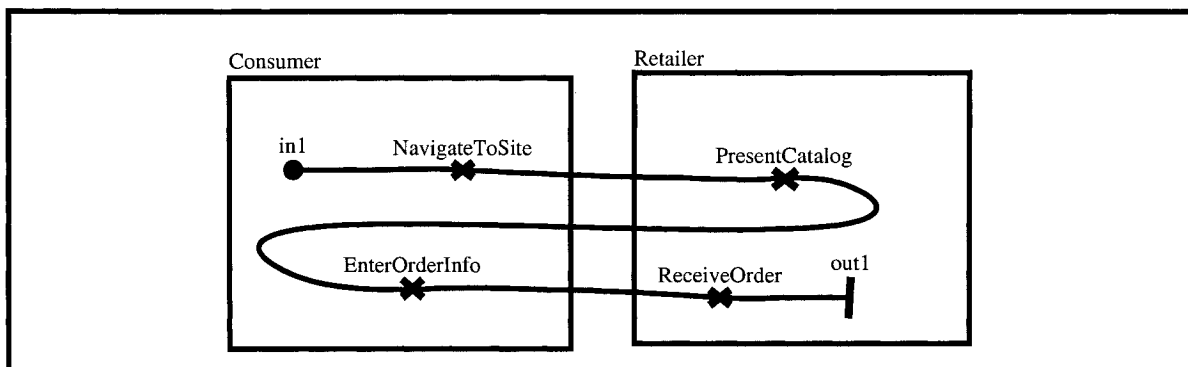

SUBMIT ORDER

UCM Navigator - WSI

Parent Map Listing

Root Map - BusinessProcessRoot Stub - SubmitOrder

Responsibilities

EnterOrderInfo

Description  
The consumer provides the order information.

NavigateToSite

Description  
The consumer navigates the Web site.

PresentCatalog

Description  
The retailer system presents its catalog.

ReceiveOrder

Description  
The retailer system receives an order that contains a list of items.

SupplyFinishedGoods

Plugin Map

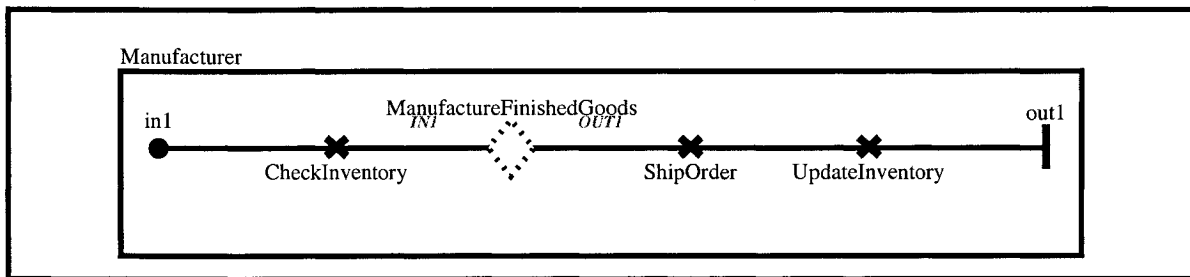

SUPPLY FINISHED GOODS

Parent Map Listing

Plugin Map - ReplenishStock Stub - SupplyFinishedGoods

Responsibilities

CheckInventory

Description  
Check the inventory for the requested product.

ShipOrder

Description  
Ship the products for that order.

UpdateInventory

Description  
Update the inventory.

## Stubs

---

Dynamic Stub - **ManufactureFinishedGoods**  
Plugin Map - **Default**  
    Selection Condition  
        SufficientInventory  
  
    Input Bindings  
        IN1 <-> in1  
    Output Bindings  
        OUT1 <-> out1  
Plugin Map - **ManufactureFinishedGoods**  
    Selection Condition  
        !SufficientInventory  
  
    Input Bindings  
        IN1 <-> in1  
    Output Bindings  
        OUT1 <-> out1

## Global Boolean Control Variables

---

CanAccessLog  
ItemListEmpty  
LogRequestValid  
MoreItems  
ProductExists  
ReplenishTimer\_timeout  
RepositoryAvailable  
SomeItemsShipped  
StockStillSufficient  
SufficientInventory  
SufficientStock  
ValidOrder  
WarehouseLeft

## Scenario Definitions

---

Scenario Group - **RejectOrder**  
Group Description  
    The product order gets rejected (because the product does not exist or because none of the goods can be found in any of the warehouses).

Scenario - **ProductDoesNotExist**  
Scenario Description  
    The order is rejected because the product does not exist.  
Scenario Starting Points  
    Start Point - **PurchaseGoods**  
    Map - **BusinessProcessRoot**  
Variable Initializations  
    ProductExists = F

Scenario - **InsufficientStock1WH1Item**  
Scenario Description  
    The order is rejected because the desired quantity of goods is not available in the single warehouse.  
Scenario Starting Points  
    Start Point - **PurchaseGoods**  
    Map - **BusinessProcessRoot**  
Variable Initializations  
    WarehouseLeft = F

## UCM Navigator - WSI

---

MoreItems = F

SufficientStock = F

ProductExists = T

ItemListEmpty = F

Scenario - **InsufficientStock1WH2Items**

Scenario Description

The order is rejected because the warehouse has insufficient stocks for all the the desired products.

Scenario Starting Points

Start Point - **PurchaseGoods**

Map - **BusinessProcessRoot**

Variable Initializations

WarehouseLeft = F

MoreItems = T

SufficientStock = F

ProductExists = T

ItemListEmpty = F

Scenario - **InsufficientStock2WH1Item**

Scenario Description

The order is rejected because none of the warehouses have sufficient quantities of the desired product.

Scenario Starting Points

Start Point - **PurchaseGoods**

Map - **BusinessProcessRoot**

Variable Initializations

WarehouseLeft = T

MoreItems = F

SufficientStock = F

ProductExists = T

ItemListEmpty = F

Scenario - **InsufficientStock2WH2Items**

Scenario Description

The order is rejected because none of the warehouses has sufficient stocks for any of the desired products.

Scenario Starting Points

Start Point - **PurchaseGoods**

Map - **BusinessProcessRoot**

Variable Initializations

WarehouseLeft = T

MoreItems = T

SufficientStock = F

ProductExists = T

ItemListEmpty = F

Scenario Group - **ShipmentConfirmed**

Group Description

Scenarios where the shipment is done, with or without replenishment.

Scenario - **PrimaryScenario**

Scenario Description

The warehouse has the item.

Scenario Starting Points

Start Point - **PurchaseGoods**

Map - **BusinessProcessRoot**

Variable Initializations

ProductExists = T

SufficientStock = T

WarehouseLeft = F

MoreItems = F

ItemListEmpty = T

StockStillSufficient = T

Scenario - **ShipmentWithReplenishmentSuffInv**

Scenario Description

The warehouse has the desired item. Replenishment with sufficient inventory.

Scenario Starting Points

Start Point - **PurchaseGoods**

## UCM Navigator - WSI

---

### Map - **BusinessProcessRoot**

Variable Initializations  
ProductExists = T  
SufficientStock = T  
WarehouseLeft = F  
MoreItems = F  
ItemListEmpty = T  
StockStillSufficient = F  
ValidOrder = T  
SufficientInventory = T

### Scenario - **ShipmentCannotReplenishInvalidOrder**

Scenario Description  
The warehouse has the desired item. However, during replishment, the order is judged invalid.

Scenario Starting Points  
Start Point - **PurchaseGoods**  
Map - **BusinessProcessRoot**

Variable Initializations  
ProductExists = T  
SufficientStock = T  
WarehouseLeft = F  
MoreItems = F  
ItemListEmpty = T  
StockStillSufficient = F  
ValidOrder = F

### Scenario - **ShipmentWithReplenishmentInsuffInv**

Scenario Description  
The warehouse has the desired item. During replishment, the inventory is insufficient and manufacturing gets involed.

Scenario Starting Points  
Start Point - **PurchaseGoods**  
Map - **BusinessProcessRoot**

Variable Initializations  
ProductExists = T  
SufficientStock = T  
WarehouseLeft = F  
MoreItems = F  
ItemListEmpty = T  
StockStillSufficient = F  
ValidOrder = T  
SufficientInventory = F

### Scenario - **ShipmentByNextWarehouse**

Scenario Description  
The first warehouse has insufficient stocks but the second one provides the shipment.

Scenario Starting Points  
Start Point - **PurchaseGoods**  
Map - **BusinessProcessRoot**

Variable Initializations  
ProductExists = T  
SufficientStock = F  
WarehouseLeft = T  
MoreItems = F  
StockStillSufficient = T  
ItemListEmpty = F

### Scenario Group - **PeriodicReplenishment**

Group Description  
Scenarios for the periodic replenishment architectural alternative.

### Scenario - **StopRightAway**

Scenario Description  
The periodic replenishment is stopped before being performed even once.

Scenario Starting Points  
Start Point - **StartPeriodicRep**  
Map - **PeriodicReplenishment**  
Start Point - **StopPeriodicRep**

## UCM Navigator - WSI

---

### Map - **PeriodicReplenishment**

Variable Initializations

ReplenishTimer\_timeout = F

### Scenario - **CheckButStocksSufficient**

Scenario Description

The periodic replenishment is checked but stocks are sufficient.

Scenario Starting Points

Start Point - **StartPeriodicRep**

Map - **PeriodicReplenishment**

Start Point - **StopPeriodicRep**

Map - **PeriodicReplenishment**

Variable Initializations

ReplenishTimer\_timeout = T

SufficientStock = T

### Scenario - **CheckAndStockInsufficient**

Scenario Description

The periodic replenishment is checked and stocks need to be increased. The order is valid and the inventory is sufficient.

Scenario Starting Points

Start Point - **StartPeriodicRep**

Map - **PeriodicReplenishment**

Start Point - **StopPeriodicRep**

Map - **PeriodicReplenishment**

Variable Initializations

ReplenishTimer\_timeout = T

SufficientStock = F

ValidOrder = T

SufficientInventory = T

### Scenario - **CheckAndStockInventoryInsufficient**

Scenario Description

The periodic replenishment is checked and stocks need to be increased. The order is valid and the inventory is insufficient.

Scenario Starting Points

Start Point - **StartPeriodicRep**

Map - **PeriodicReplenishment**

Start Point - **StopPeriodicRep**

Map - **PeriodicReplenishment**

Variable Initializations

ReplenishTimer\_timeout = T

SufficientStock = F

ValidOrder = T

SufficientInventory = F

### Scenario - **CheckAndStockInsufficientInvalidOrder**

Scenario Description

The periodic replishment is checked ans stocks need to be increased. The order is however invalid (malformed, invalid product or invalid quantity).

Scenario Starting Points

Start Point - **StartPeriodicRep**

Map - **PeriodicReplenishment**

Start Point - **StopPeriodicRep**

Map - **PeriodicReplenishment**

Variable Initializations

ReplenishTimer\_timeout = T

SufficientStock = F

ValidOrder = F

## Hardware Devices

---

### Processors

Device Name - **ConsumerProc**

-

**UCM Navigator - WSI**

---

Operation Time - **1.000000e+00**

Device Name - **RetailWHproc**

Operation Time - **2.000000e+00**

Device Name - **ManuProc**

Operation Time - **3.000000e+00**