

INFORMATION TO USERS

This manuscript has been reproduced from the microfilm master. UMI films the text directly from the original or copy submitted. Thus, some thesis and dissertation copies are in typewriter face, while others may be from any type of computer printer.

The quality of this reproduction is dependent upon the quality of the copy submitted. Broken or indistinct print, colored or poor quality illustrations and photographs, print bleedthrough, substandard margins, and improper alignment can adversely affect reproduction.

In the unlikely event that the author did not send UMI a complete manuscript and there are missing pages, these will be noted. Also, if unauthorized copyright material had to be removed, a note will indicate the deletion.

Oversize materials (e.g., maps, drawings, charts) are reproduced by sectioning the original, beginning at the upper left-hand corner and continuing from left to right in equal sections with small overlaps. Each original is also photographed in one exposure and is included in reduced form at the back of the book.

Photographs included in the original manuscript have been reproduced xerographically in this copy. Higher quality 6" x 9" black and white photographic prints are available for any photographs or illustrations appearing in this copy for an additional charge. Contact UMI directly to order.

UMI

**A Bell & Howell Information Company
300 North Zeeb Road, Ann Arbor MI 48106-1346 USA
313/761-4700 800/521-0600**



UNIVERSITÉ D'OTTAWA
UNIVERSITY OF OTTAWA

**An Explanation for Ergative versus Accusative Languages:
An Examination of Inuktitut**

by

Louise Schieberl Manga

M.A. University of Ottawa (1992)

A Thesis presented to
the School of Graduate Studies and Research
in fulfillment of thesis requirement for the degree of
Doctor of Philosophy
in Linguistics

Université d'Ottawa/University of Ottawa

©Louise Schieberl Manga, 1996

All Rights Reserved



**National Library
of Canada**

**Acquisitions and
Bibliographic Services**

**395 Wellington Street
Ottawa ON K1A 0N4
Canada**

**Bibliothèque nationale
du Canada**

**Acquisitions et
services bibliographiques**

**395, rue Wellington
Ottawa ON K1A 0N4
Canada**

Your file *Votre référence*

Our file *Notre référence*

The author has granted a non-exclusive licence allowing the National Library of Canada to reproduce, loan, distribute or sell copies of his/her thesis by any means and in any form or format, making this thesis available to interested persons.

The author retains ownership of the copyright in his/her thesis. Neither the thesis nor substantial extracts from it may be printed or otherwise reproduced with the author's permission.

L'auteur a accordé une licence non exclusive permettant à la Bibliothèque nationale du Canada de reproduire, prêter, distribuer ou vendre des copies de sa thèse de quelque manière et sous quelque forme que ce soit pour mettre des exemplaires de cette thèse à la disposition des personnes intéressées.

L'auteur conserve la propriété du droit d'auteur qui protège sa thèse. Ni la thèse ni des extraits substantiels de celle-ci ne doivent être imprimés ou autrement reproduits sans son autorisation.

0-612-21007-3

Abstract

This dissertation shows that when specific objects are checked accounts for a language being ergative or accusative. In ergative languages a specific object is checked at Spell-out by the object moving to [Spec, T] with the resultant Abs/Nom case marking of the object. This accounts for the wide scope only reading of Abs/Nom objects and native speakers interpretations of Abs/Nom objects as specific/referential. Since the object moves to [Spec, T] the subject remains inside the VP and is assigned Gen/Erg case by V. In accusative languages a specific object is not checked until after Spell-out and the subject moves to [Spec, T] where it gets Nom case and the object remains inside the VP where it gets Acc case. This accounts for the possibility of wide and narrow scope readings for Acc objects.

Ergative languages are also characterized as having "split ergativity" whereby there is also a nominative-accusative case marking/agreement pattern. This is also explained. Specific objects move outside the VP at Spell-out with the resultant ergative case marking, while non-specific objects remain inside the VP are assigned Inst/Acc case through insertion of a postposition with the resultant accusative case marking pattern.

This explanation for the existence of ergative and accusative languages eliminates the need for the stipulation in the Minimalist Program (Chomsky 1995, Chapter 4) that arguments have to move to have features checked while features on non-arguments could be checked *in situ*. It also illustrates the type of feature that is checked, and that features triggering movement for checking can be on the moved item.

The analysis of ergativity is based on the North Baffin dialect of Inuktitut and uses field

work data on sentences and nominals. The data on sentences shows that a speaker can make specific or non-specific reference to all types of objects: personal names, demonstratives, modified nouns, quantified nouns. It also shows that the audience interprets a specific object as the speaker intending to pick out an entity. Specificity is thus shown to be part of the semantic component (Donnellan 1966, 1978). The data on nominals supports the analysis of case assignment: arguments of derived and non-derived nominals have Erg/Gen case, and the subject and object arguments of gerunds have Erg/Gen and Inst/Acc cases respectively. Finally a discussion of agreement in Inuktitut supports the analysis of agreement being a relation rather than a functional projection, and the checking of specific objects at Spell-out.

*This thesis is dedicated to
the memory of my parents
Amelia and Joseph
and to my sons
Michael, Peter and David.*

Acknowledgements

Writing my thesis was a great source of satisfaction and pleasure, and there are many people and groups that I would like to thank. First I would like to thank Ann Laubstein at Carleton University who first taught me theoretical syntax and phonology, and who made it so exciting that I changed my field of study. Next I would like to thank Paul Hirschbühler who supervised my M.A. thesis *The Syntax of Adverbs in English*. I learned how to write a thesis which made it so much easier when he supervised my Ph.D. thesis. He also approved my taking Paul Mercier's course Introduction to Mandarin, an excellent course and an exemplar for the way a language should be taught. To Ian MacKay, thank you for the course in experimental phonetics, the course that was the most fun of any I have taken, and which led to my second comprehensive paper *A Phonetic Analysis of Advanced Tongue Root in Vowel Harmony in Akan*. Thank you also Marc Authier for supervising my first comprehensive paper *Specificity in Inuktitut*. The insights were only possible because of the articles he suggested I read. My Ph.D. thesis developed from this paper. Thanks to Helen Goodluck who supervised my fieldwork, which began in the area of language acquisition but changed to syntax. I learned many useful skills in eliciting speaker competence while working as a research assistant for her. I again thank Paul Hirschbühler who supervised my Ph.D. dissertation. He made many suggestions which helped clarify what I was trying to say, and, most importantly, he let me pursue the study and ideas I needed to. I was honoured to have as thesis examiners Louis-Jacques Dorais, Alana Johns, Kumiko Murasugi and John Jensen. They have vast experience in Inuktitut linguistics, morphology, syntax and the Minimalist Program; and made insightful comments.

Students Janet Benger, Lisa Reed, Erato Kostopoulou and Darlene LaCharité were welcoming when I first arrived to do my M.A.; Kofi Saah made time in his busy schedule for me to make and analyze many recordings of his voice. It was especially nice having Michele Foley, Subhadra Ramachandran, and Mohammed L. Vahedi as colleagues during my M.A. and Ph.D., and Badia Zerbouni during my Ph.D. I would like to thank my fellow students for their support: Angelique Kotsopoulos, Shahla Raghibdoust, Margarete Ling, Galena Alexandrova, Ahmad Moinzadeh, Reza Samar and Laura Proctor (our computer expert). Special mention must be made to my good friends Savitri and Shyam Khanna who were true life savers.

The completion of my studies has also been greatly facilitated by Yolande Theriault, the departmental secretary. She ensured the various forms, registration and otherwise, were correctly filled out, and always knew the correct codes. Her smiles and pleasant disposition made the department a welcoming place.

The Inuktitut data in this dissertation was only possible through three grants that I received from the Northern Scientific Training Program for linguistic fieldwork in Igloolik, NWT in August 1992, April-August 1993, November-December 1994 and March 1995. I would like to express my sincere thanks to the community of Igloolik for giving me the opportunity to go there to do fieldwork. The incredible beauty of the land and the kindness of the people are forever etched on my being. I would also like to thank the native informants that worked for me: Andre Uttak, Simeonie Attagutalukutuk, and those who are anonymous either by choice or because I haven't been able to check if they would like their names printed. My research was facilitated by the excellent facilities at the Igloolik Research Centre. I would like to thank John McDonald at the Igloolik Research Centre for all his assistance and logistical support. Many

thanks also to Leah Otak of the Igloolik Research Centre for her help in times of need.

My final acknowledgment goes to my good friends, Patience, Constance and Charity, whom I met while doing my M.A. thesis. They have been true and faithful friends that have stuck with me to the very end. It's too bad that Prudence didn't stick it out.

Table of Contents

1. Introduction	1
1.1 Introduction	1
1.2 Case in Government and Binding Theory	9
1.3 Case Assignment and Modified Syntactic Structure	18
1.4 Case in the Minimalist Program	22
1.4.1 Early Minimalist Program	22
1.4.2 Later Minimalist Program	27
1.4.3 Abs (=Nom) Objects in the Minimalist Program	33
1.5 Application to Inuktitut	40
1.6 Summary	46
2. Case Marking and Speaker Intentions	49
2.1 Introduction	49
2.2 Specificity Marks Speaker Intentions	51
2.2.1 Lexical Items	53
2.2.2 Minimal Sentence	55
2.2.3 Coordinated Sentences	56
2.2.4 Native Speaker's Interpretations	57
2.2.5 Stories and Spontaneous Speech	57
2.3 Specificity is Semantic	59
2.4 Specificity in English	61
2.4.1 Specificity and Definite NPs	63
2.4.2 Specificity and Pronominal NPs	68
2.4.3 Heim's Critique of Donnellan	69
2.4.4 Summary	74
2.5 Specificity in Ergative and Accusative Languages	75
3. Parametric Explanations for Erg-Abs Case Marking	85
3.1 Lexical Properties Parameter	85
3.2 Obligatory Case Parameter	90
3.3 Transitivity Parameter	99
3.4 Case-Binding Configuration	104
3.5 The Dual Case Pattern	114
4. Nominal Phrases	126
4.1 Introduction	126
4.2 Nouns and Deverbal Nominals	127
4.2.1 Underived Nominals	127
4.2.2 Deverbal Nominals	128
4.2.3 Summary	130
4.3 Gerundive Nominals	131

4.4 Parametric Explanations	134
4.4.1 Lexical Properties Parameter	134
4.4.2 Obligatory Case Parameter	136
4.4.3 Transitivity Parameter	137
4.4.4 Case-Binding Configuration	137
4.4.5 Dual Case-Marking	147
4.5 Summary	152
5. Agreement	153
5.1 Introduction	153
5.2 Agreement as a Manifestation of a Spec-head Relation	157
5.3 Agreement Patterns	161
5.3.1 Main Clause Agreement	161
5.3.2 Subordinate Clause Agreement	167
5.4 Conclusion	174
Appendix A	177
Appendix B	179
6. Conclusion	180
7. Bibliography	189

Abbreviations

A	absolutive/nominative agreement
Abl	ablative case (also marks passive 'by' phrase); also called dative in some texts; <i>-mut</i>
Abs	absolutive/nominative case; always null
Acc	accusative case
Ag	agent argument
All	allative case
AP	antipassive
BECAUS (CAUS)	becauseative subordinate mood
BEN	benefactive morpheme
CL	clitic
COMP	comparative
COND	conditional subordinate mood
d	dual
Def	definite
doee	recipient of verb
ds	different subject from matrix clause
DUB	dubitative subordinate mood
E	ergative/genitive agreement
Erg	ergative/genitive case
FREQ	frequentive subordinate mood
Gen	genitive case
IND	indicative main mood
Inst	instrumental/accusative case; <i>-mik</i>
&	voiceless lateral fricative
Loc	locative case
Mod	modalis case; <i>-mik</i>
niq	nominalizer (<i>-ing</i>)
Nom	nominative case
NONFUT	nonfuture
OPT	optative main mood
Obl	oblique
P	patient/theme argument
PART	participial subordinate mood
PASS	passive morpheme
PAST	past tense
pl	plural
POSS	possessor agreement
Q	interrogative main mood
sg	singular
ss	same subject as in matrix clause
T	tense

Source of Examples

B	Bittner
BB	Bok-Bennema
Bo	Bobaljik
C	Chomsky
C & L	Chomsky and Lasnik
D	Donnellan
F	Fabb
F & S	Fukui and Speas
Fo	Fortescue
G	Gruber
H	Heim
J	Johns
M	Mallon
Mi	Miyagawa
Mu	Murasugi
S I	Spalding, Volume I
S II	Spalding, Volume II

Inuktitut examples with no source cited are from my fieldwork conducted at various times between May 1993 and December 1995 with North Baffin dialect speakers in Igloolik and in Ottawa.

Figure 1

Arctic Languages: An Awakening. Paris: UNESCO p. 189.

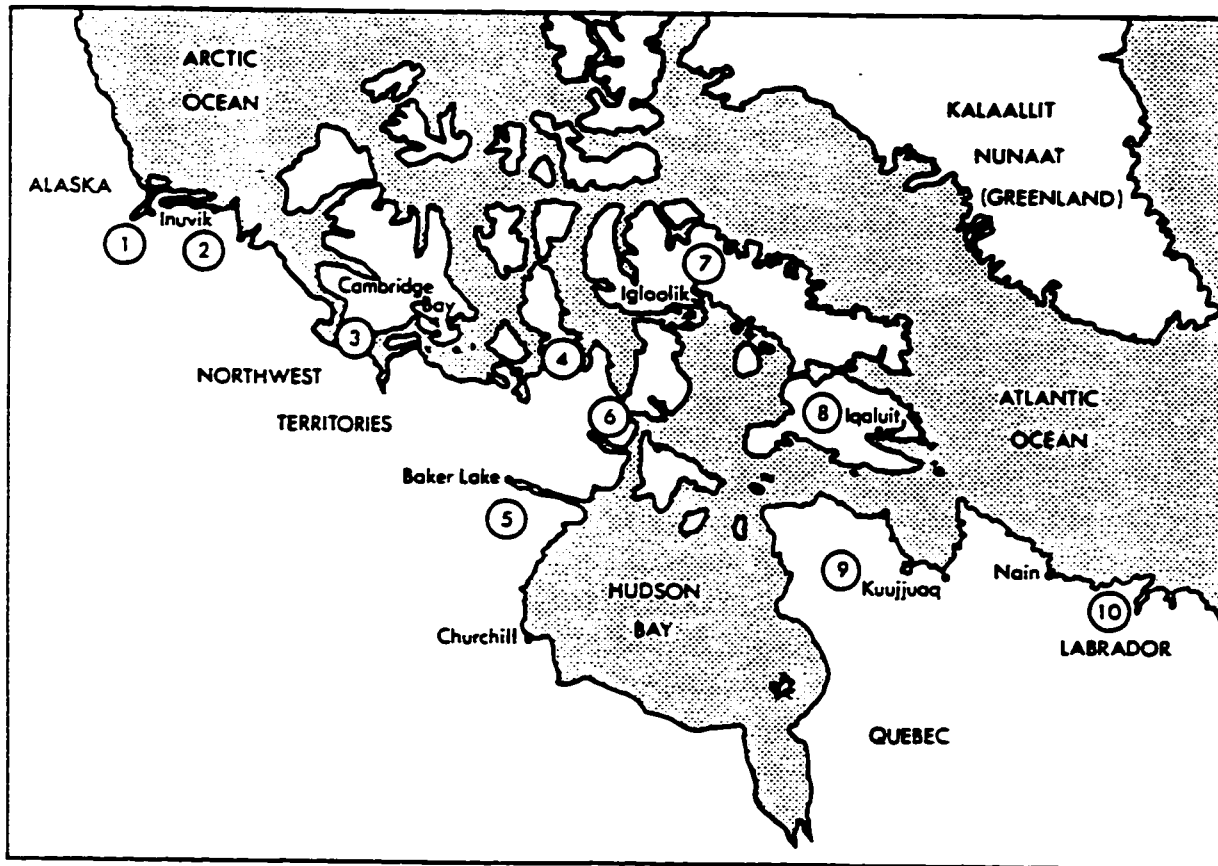

MAP 6. Inuit territory and language groups in Canada: (1) Uummarmiutun; (2) Siglitun; (3) Inuinnaqtun; (4) Natsilik; (5) Kivallirmiutun; (6) Aivilik; (7) North Baffin; (8) South Baffin; (9) Arctic Quebec; (10) Labrador. *Source:* Reproduced by permission of the author, L.-J. Dorais.

Chapter 1

Introduction

1.1 Introduction

The language of the Inuit (Eskimo) is described as an ergative language (cf. Dixon 1994, Manning 1994, Murasugi 1992a, Johns 1987). The languages of the Inuit include Yupik spoken in Alaska and Russia (Kaplan 1990, Menovshchikov 1990), Western Inuktitun (Siglitun, Inuinnaqtun, Natsilik, Kivallirmiutun dialects) and Eastern Inuktitut (Aivilik, North Baffin, South Baffin, Arctic Quebec, Labrador dialects) spoken in Canada (Dorais 1990), and Greenlandic Eskimo spoken in Greenland (Fortescue 1990). The map in Figure 1 shows the distribution of the dialects in Canada.

In an ergative language, S (the subject of an intransitive verb) and O (the object of a transitive verb) pattern the same; whereas, in an accusative language, the subjects of intransitive and transitive verbs pattern the same. This distinction is commonly referred to as S/O or S/P (patient) versus S/A (agent) (cf. Dixon 1994, Blake 1994). Inuktitut examples are shown in (1).

- (1) a. anguti.up tuktu taku.janga
man.Erg caribou(Abs) see.IND3E/3A
'the/a man saw the caribou'
- b. kanna nattiq mikit.tuq (S I: p. 8)
down-there(Abs) seal(Abs) short.IND3A
'that seal down there is short'

The subject function (*pivot* in Dixon's (1994) and Manning's (1994) terms) is the object¹ *tuktu* in (1a) and the subject *kanna nattiq* in (1b).

¹The terms 'object' and 'subject' refer to thematic roles, while terms like 'subject function' or 'subject of a sentence' refer to the syntactic position of the NP in the sentence.

A further distinction made when describing a language as ergative is to distinguish syntactic ergativity from morphological ergativity. Syntactic ergativity describes an S/O patterning together for grammatical relations such as subject of a sentence, coordination, relativization. Morphological ergativity refers to ways a language uses to mark an S/O patterning, for example case marking and verbal affixes. Case marking to group S/O is seen in (1) where both the O and the S have Abs(olutive) case (Abs case is universally almost always null (Dixon 1994, Blake 1994)). Morphological marking via verbal affixes is clearly illustrated by the examples in (2) which show the 'because' mood marker plus verbal agreement affixes.

- | | | |
|--|--|--|
| (2) a. ...ga.vit
...BECAUS.2sgA
'because you...' | b. ...ga.mi.tit
...BECAUS.3ssE.2sgA
'because he...you' | c. ...Nma.a.tit
...BECAUS.3dsE.2sgA
'because he...you' |
|--|--|--|

There is an agreement marker *-vit* for S in (2a) and *-tit* for O in (2b) and (2c). In the transitive examples (2b) and (2c) there is also an agreement marker for the semantic subject *he*. Syntactic and morphological ergativity are related in that "no language is known that is ergative at the syntactic but not at the morphological level" (Dixon 1994: 172).

There are four major complications to this rather simplistic description of Inuktitut as ergative. First, S/O pattern alike with respect to grammatical relations such as coordination and relativization but not for binding relations which pattern like accusative languages. Manning (1994) describes binding as applying at the level of argument structure.² In the Minimalist Program, Binding Theory holds at the LF interface with anaphors moving at LF to be in a Spec-head relation with their antecedent (Chomsky 1992, Lasnik 1993). Still other accounts for

²Manning (1994) uses a different theoretical framework, but his argument structure would be equivalent to the D-structure of the government and binding model.

binding are given by Bok-Bennema (1991) and (Bittner 1994a) for West Greenlandic.

Second, although you do find an S/O pattern as in (1), you also find another pattern as in (3) and (4). Compare (1a) repeated here as (3a) with (3b).

(3) a. anguti.up tuktu taku.janga
man.Erg caribou(Abs) see.IND3E/3A
'the/a man saw the caribou'

b. anguti tuktu.mik taku.juq
man(Abs) caribou.Inst see.IND3A
'the/a man saw a caribou'

(4) a. qiturngaq silamii.guma.juq (S I: p. 31)
child(Abs) be-outside.want.IND3A
'the child wants to be outside'

b. atausi.tuinnar.mik taku.juq (S I: p. 12)
one.only.Inst see.IND3A
'he saw just one'

The subject of the intransitive sentence in (4a) and the subject of the transitive sentence in (3b) both have Abs case. The object in (3b) and (4b) is marked with Inst(rumental) case. Thus we also seem to have an S/A patterning. One approach (Dixon 1994: 122-123) is to consider examples like (3b) and (4b) where there are two core roles as 'extended intransitives' with one mapped to S (Abs) and another marked in some other way, e.g., Dat(ive), or with an antipassive morpheme. In such an approach examples (3b) and (4b) are considered as forms derived from the transitive as in (3a). Another approach might be to say that the reference to intransitive and transitive verbs is not based on argument structure, but on the morphological agreement that is on the verb (cf. Johns 1993). Thus a 'transitive verb' has agreement morphemes that indicate both thematic subject and thematic object; while an 'intransitive verb' has agreement only for the thematic subject. However this does not explain why a transitive verb might have agreement for

thematic subject and object or agreement only for thematic subject. Our approach, which is explicated in Chapter 2, derives neither one from the other, and explains why there are the two types of agreement patterns for transitive verbs.³ It will show that both have the same argument structure but that the ergative form (as in (3a)) results from speaker's intentions to pick out the object. In terms of the Minimalist Program (Chomsky 1992), the contrast between the two linguistic expressions (3a) and (3b) will be seen to represent different intentions that optimally satisfy the interface conditions of the conceptual-intentional and articulatory-perceptual levels. Both the case and agreement patterns will be shown to fall out from Spec-head agreement feature checking.

Thirdly, the same case has different labels, depending upon the linguist. Possessive constructions and morphologically 'transitive verbs' as in (3a) have the same case marking and agreement morphology. The thematic-subject/possessor has *-up* case marking and there is a thematic-subject/possessor agreement morpheme on the verb/noun. Compare (5a) ((3a) repeated here) with (5b) where the subject *anguti* in (5a) has the same case marking, *-up*, as the possessor *Maali* in (5b). The head V/N also has agreement morpheme, *-nga*, that indicates person and number of the *-up* marked thematic-subject/possessor.

(5) a. *anguti.up tuktu taku.janga*
 man.Erg caribou(Abs) see.IND3E/3A
 'the/a man saw the caribou'

b. *Maali.up anaana.nga* (S I: p. 60)
 Molly.Gen mother.3POSS(Abs)
 'Molly's mother '

³Kalmar (1979) also argues that the two clause types are not derived one from the other, and he argues that the choice of clause type is a direct result of semantic and contextual circumstances.

tive grammars use the terms Rel(ative), Abs and Inst(rumental)/Mod(alis)/Comit(ative), where Rel includes both Erg(ative) and Gen(itive) case marked nouns (cf. Woodbury (1985) and de Reuse (1994) for Yupik, Fortescue (1986) for West Greenlandic Eskimo, Johns (1987) for Inuktitut). Grammars for North Baffin Inuktitut use the terms Gen, Nom(inative) and Acc(usative) (cf. Spalding (1992 [1979]), Harper (1974) and Dorais (1978)). Still other grammars do not use case terms at all but refer to relative, subject and modalis functions (Lowe (1985) for Siglit) or refer to noun endings associated with particular grammatical, locative or equal functions (Mallon (1991) for Inuktitut). Still others, especially those trying to account for ergativity among languages in general, use various combinations of the terms Erg, Gen, Abs, Nom, Inst/Mod. For example, Murasugi (1992a) and Bittner (1994a) use Erg and Nom, and Bok-Bennema uses Erg and Abs but switches to Gen and Nom (for other examples see Manning (1994), Sadock (1994)).⁴ Often Nom is used instead of Abs. Blake (1994) uses the term Abs when distinguishing languages that mark the grammatical relations of S and O the same from languages that mark S and A the same, and the term Nom when referring to the case marking to indicate that the case, whether for S/O or S/A, is the unmarked one.

Recent attempts to account for the choice of Erg-Abs case marking versus Nom-Acc case marking have posited the existence of a parameter as the explanation for which type of case marking a language uses (for Inuktitut in particular, see Johns (1992), (1993); Murasugi (1992a), (1992b); Bobaljik (1993)). The various parametric approaches to account for the case marking view ergative languages such as Inuktitut as fundamentally different from non-ergative languages,

⁴Since an Erg subject could just as easily be called a Gen subject, an Abs object a Nom object, and an Inst object an Acc object, I will refer to the case marked arguments as Erg/Gen, Abs/Nom and Inst/Acc in Section 1.5 and the remaining chapters.

the difference depending upon the formulation of the parameter. This paper will show that the syntactic structure of Inuktitut is very much like Nom-Acc languages and that a special parameter is not needed to account for its pattern of case and agreement. Chapter 3 shows what is wrong with each of these parametric accounts, and with the explanations by Bok-Bennema (1991) and Bittner (1994a) for the case marking in West Greenlandic. These five accounts are also unable to explain the case marking pattern in gerunds. Chapter 4 looks at gerunds in Inuktitut, and the analysis supports the assignment of case developed in Chapters 1 and 2.

Lastly, the similarity of Erg/Gen case and pronominal affixes marking the Erg/Gen subject and possessor as noted in (5) for Inuktitut (see also Mallon (1991), Johns (1987, 1992) and Murasugi (1992b)) is also observed in other languages (see Allen (1964) and Dixon (1974)). A simplistic description of Inuktitut as ergative does not explain why this parallel exists. First, the Erg/Gen case marker *-up* is the same for the thematic-subject of the clause as in (5a) and for the possessor-subject for the NP as in (5b) and (6a). Second, the agreement morpheme on the verb in Erg/Gen-Abs/Nom IND(icative) clauses and the possessor agreement morpheme on the Abs/Nom possessum are the same. For example in (6b) and (6c) the agreement marker *-vut* on the possessed N indicates a 1st person plural possessor and *-vut* is also the agreement marker that is used to indicate a 1st person plural thematic subject in Erg/Gen-Abs/Nom IND clauses as in (6b).

- (6) a. [Taami.**up** qukiuti.**nga**] qai.jjuti.laur.tara (S II: p. 8)
 [Tommy.Erg rifle.3POSS(Abs)] come.BEN.PAST.IND1E/3A
 'I came for Tommy's rifle (with that in mind)'
- b. [anaanakkuti.**vut**] nagligi.vavut (S I: p. 57)
 [parents.1plPOSS(Abs)] love.IND1plE/3plA
 'we love our parents'

- c. [qimmi.vut] quinijukulu.u.lir.tut (S I: p. 57)
 [dog.(pl)IplPOSS(Abs)] pleasingly-and-healthily-fat.be.state.IND3plA
 'our dogs are pleasingly and healthily fat'

The derivation of agreement as well as the assignment of case are important in the explanations of various parameters posited for why a language has Erg-Abs or Nom-Acc case marking. Chapter 5 discusses the pattern of agreement on possessed NPs and in clauses, which will be shown to support my analysis of case assignment in Inuktitut.

Chapter 6 summarizes the analysis of ergativity in Inuktitut and relates the findings to other ergative languages. Since an explanation for case marking is prominent in the argument presented in this paper, the rest of this introductory chapter will be a theoretical overview of Case Theory within the generative grammar paradigm from Chomsky (1986a) to the Minimalist Program. Briefly, case is important because I show in Chapter 2 that a sentence will have Erg/Gen-Abs/Nom case marking as in (7a) if the speaker intends to pick out a particular entity and Abs/Nom-Inst/Acc case marking as in (7b) if the speaker is not picking out a particular object (Manga 1994a, 1996).

Erg/Gen-Abs/Nom

- (7) a. taanna ikaju.lauq.tara
 that-one-here(Abs) help.PAST.IND1E/3A
 I helped that person here

Abs/Nom-Inst/Acc

- b. taatsuminga ikaju.lauq.tunga
 that-person-here-Inst help.PAST.IND1A
 I helped that person here

When the speaker picks out a particular entity the object moves outside the VP to take wide

scope.⁵ The object moves to [Spec, T] where it checks/gets Abs/Nom Case and the subject remains inside the VP where it checks/gets Erg/Gen case in [Spec, V]. When the speaker does not pick out a particular individual, the object remains inside the VP and the subject moves to [Spec, T] where it checks/gets Abs/Nom Case. The object will then get Inst/Acc Case. The assignment/checking of Abs/Nom and Inst/Acc cases in Inuktitut can now be seen to be the same as case assignment is assumed to be within a system of universal grammar. "In some languages, Case is morphologically realized, in others not, but we assume that it is assigned in a uniform way whether morphologically realized or not. We assume that objective Case is assigned to the object of a verb and nominative Case to the subject of a finite clause, and that prepositions assign oblique case to their objects." (Chomsky 1986a: 74). This description of case assignment does not mention Gen Case. Genitive case is also structural (cf. Miyagawa (1993), Libert (1992)) and in Inuktitut genitive case is the same as ergative and would also be structural. Following the Minimalist Program, these structural cases are also checked/assigned in a Specifier-head relation.

In accusative languages Nom and Acc are considered to be structural cases, while Gen may or may not be. In ergative languages since the following cases are equated: Abs=Nom, Inst=Acc, and, in some ergative languages, Erg=Gen, are Abs, Inst and Erg structural cases? The issue is important for empirical reasons if it can explain why certain arguments have the particular cases they do and exhibit perhaps certain movement constraints. And it is of theoretical importance in the organization of language. The focus in Section 1.2 (Case Theory in Government and Binding Theory (GB) as presented in *Knowledge of Language* (Chomsky

⁵Bittner (1987) describes the scope properties of Abs/Nom objects and objects with Inst/Acc case, but does not provide an account for why these scope properties exist.

1986a)) and Section 1.3 (modifications to the syntactic model used in *Knowledge of Language* and the effect on Case Theory) is thus on Gen case. Section 1.4 describes case marking in the Minimalist Approach. Section 1.5 analyzes case marking in Inuktitut, and is thus able to relate the case marking in accusative and ergative languages. Section 1.6 is a summary of the discussion of case and gives an outline of the following chapters.

1.2 Case in Government and Binding Theory

This section describes how Case is handled in Government and Binding (GB) Theory as outlined in Chomsky (1986a). The focus is on Gen case since it was considered an inherent rather than structural case, and since Gen=Erg in Inuktitut and in other ergative languages. Examples of Gen NPs in English are provided in (8), (9) and (10). An NP with Gen case can be base generated in subject position with θ -roles such as possessor⁶ in (8a), and agent in (8b) and (9a), or it can be an NP argument that has moved to the Spec(ifier) position as in (8c) and (9b), or even an adverb as in (8d). NP arguments in complement position of an N as in (10) and of an adjective as in (11b) are also considered to get Gen case through *of*-insertion

- (8) a. *John's* book (C 1986a)
b. *their* destruction of the city (C 1986a)
c. *the city's* destruction (C 1986a)
d. *yesterday's* destruction of the city by the Romans (F & S: 142)

⁶There is no consensus on where possessor NPs and possessive 's are generated. For example, Fukui and Speas (1986: 152) and Lobeck (1991) would have the 's in D (i.e., the head of a functional projection) with *John* moving from [Spec, N] to [Spec, D]. Libert (1992) has possessive 's in K (the head of the syntactic case phrase KP) or in P (the head of the semantic case phrase PP) with the D head empty; and the NP possessor in [Spec, K] or [Spec, P].

(9) a. [*John's reading the book*] disturbed me (C 1986a)

b. *John's having been appointed* (C 1986a)

(10) a. the destruction of *the city*

b. the appointment of *John*

N heads can have Gen NP subjects (8), and gerunds can have Gen NP subjects (9). But adjectives cannot have an NP argument in [Spec, AdjP] and getting Gen as in (11a).

(11) a. **John's proud* (C 1986a)

b. proud of John

Note that the entire NP gets Gen as shown in (12) from Fabb (1984: 85).

(12) [*the capital of Italy*]'s greatest hero

Case Theory as outlined in Chomsky (1986a) will now be presented.⁷ The Case Filter requires phonetically realized NPs to have case. Although *John to be the winner* in (13) gets Nom case from Infl, the NP *John* cannot get Case, and hence the sentence is ungrammatical.

(13) *{*John to be the winner*} is unlikely (C 1986a: 186 (258viii))

The Case Filter is NOT stated as nouns are required to have case since nominal expressions without noun heads such as gerunds, infinitivals and prepositional phrases also need to be in case marked positions as in (14) (see Chomsky (1986a) p. 217 fn 122).

(14) a. [*John's winning*] is unlikely

b. [*for John to win*] is unlikely

⁷For descriptions of Gen case assignment within the GB framework which distinguish possessive 's from the Gen case marker 's, see M. Anderson (1983) and Fabb (1984). See also Libert (1992) who distinguishes possessor 's as a semantic case from genitive 's as a syntactic case. For an overview of case from the late 1960s up to the Minimalist Program, see Weibelhuth (1995).

le] is the best place for that typewriter

The Case Filter is stated in terms of the visibility condition given in (15) (Chomsky (1986a): 94).

(15) **Visibility Condition: an NP can receive a θ -role only if it is in a case marked position or linked⁸ to a case marked position.**

The important issue that this paper is concerned with is how Case, in particular genitive, is assigned. "Case is uniformly assigned under government"⁹ (Chomsky 1986a: p. 188). "If the category α has a Case to assign, then it may assign it to an element that it governs" (p. 187). Case Theory distinguishes two types of case assignment: Structural Case and Inherent Case. For inherent case marking, it is also necessary to distinguish case assignment from case realization.

Structural Cases are objective and nominative.¹⁰ They are "assigned in terms of S-structure position" (p. 193) and are "assigned independently of θ -marking". V and the Agr in Infl assign structural case. Examples of the assignment of Objective Case are shown in (16). In (16a) the transitive verb governs the NP argument and assigns objective case to NP, to its

⁸'Linking' is to handle those cases where an argument has a θ -role but is not in a case marked position. An expletive is in a case marked position which is linked to the argument with a θ -role. This linking occurs at D-Structure and throughout the derivation. Since (14b) and (14c) are not really NPs it would be more appropriate to word the Visibility Condition as "an XP..." or "an argument ..."

⁹The definition of government in Chomsky (1986a) refers to the maximal projection.

¹⁰Chomsky (1981: 171) considers Gen assigned to [Spec, NP] a structural case. See Blake (1994) and the references cited therein who consider Nom, Acc, Erg, Gen, and Dat(ive) as grammatical (syntactic) cases. Blake (p. 33) notes that syntactic cases often "encode a semantic relation or role" and "on the other hand there are situations where the so-called semantic cases encode a purely syntactic relation." An example of the latter is in passives where Abl(ative) marks former subjects. For a description of the differences between semantic/lexical and syntactic cases in various theoretical framework, and for the difficulty in distinguishing semantic/lexical case from syntactic case see Libert (1992).

specifier DET and to its head N.

- (16) a. [_{VP} V [_{NP} DET [_N N ...]]] (C 1986a, eg. (259))
b. [for [_{IP}John to be the winner]] is unlikely (C 1986a, eg. (261i))
c. [for [_{IP}him to be the winner]] is unlikely

In (16b, c), the C *for* governs IP¹¹ and the specifier of IP, and assigns Case to the specifier (i.e., the subject *John* in (16b) and *him* in (16c)).

Nominative Case is assigned by the agreement element in Infl (see p. 188). The agreement element is coindexed with the subject, governs the subject since "they share all maximum projections," and assigns Nominative Case to the subject. Chomsky (1986b: 24) describes the relationship between the Agr element of Infl and the subject of IP as "SPEC-head agreement" and assumes that it is "a form of 'feature sharing' similar to θ -government--in fact, sharing of the features person, number, gender, Case, etc. ... when AGR is present [boldface mine]." In example (14a), repeated here as (17), [*John's winning*] gets Nom Case from Agr in Infl.

- (17) [*John's winning*] is unlikely

Although nouns, like verbs, can assign a θ -role to their complements, nouns do not assign objective case (see also van Riemsdijk and Williams (1986)). Even though the N governs the NP in (18b) and the IP in (19b), it does not assign Case to its complement.

- (18) a. [_V discovered [_{NP} America]]
b. * [_N discovery [_{NP} America]] (C 1986a, eg. (269))
(19) a. I believe [_{IP} John to be the winner] (C 1986a, eg. (261iii))

¹¹Note that CP and IP are C and S respectively in Chomsky (1986a).

- b. *the belief [_{IP} John to be the winner] (C 1986a, eg. (264i))

Nouns, including *belief*, do not assign Acc case to their complements. Note that, in English, epistemic verbs like *believe* are ECM verbs and do govern IP complements and assign Acc Case to [Spec, IP] as in (19a) repeated here as (20a), whereas verbs usually govern CP complements and assign Case to [Spec, CP] and not to the subject of IP as in (20b). (See Chomsky (1986a): 188-190.)

(20) a. I believe [John to be the winner]

- b. *I tried [John to be the winner]

Inherent Cases are oblique and genitive. They are assigned at D-structure, and are associated with θ -marking (i.e., α assigns inherent case to NP iff α θ -marks the NP). P assigns oblique case, and N and Adj assign genitive case. Chomsky (1986a: 202), following Kayne, suggests that in case-impooverished English, oblique case is not assigned by P, rather objective case is. The discussion of inherent case therefore focused on genitive case.

As shown in (21), English can have GEN subjects (21a) or GEN complements (21b). Both (21a) and (21b) would be generated from the D-Structure in (21c).

(21) a. [the city]'s destruction (C 1986a: 192 (270ii))

b. the [destruction [of the city]] (C 1986a: 192 (270iii))

c. the [destruction [the city]] (C 1986a: 192 (270i))

In describing structural case assignment it was noted that nouns do not assign case to their complements. Yet nouns and adjectives, like verbs, have argument structure. This D-structure created is licensed, but the arguments need case and according to Case Theory, N and Adj do not assign Acc case to arguments. The problem is how do the θ -role complements of N or P get

case? There are two possible solutions described for English: either (i) move- α and a genitive assignment rule yields (21a), or (ii) *of*-insertion¹² yields (21b) (Chomsky 1986a: 192). In English, Ns allow either solution (i) or (ii), but Adjs allow only solution (ii) as shown in (22a) versus (22b), with (22c) being the D-Structure.

(22) a. *John's proud

b. proud [of John] (C 1986a, (271ii))

c. proud [John] (C 1986a, (271i))

Following Koopman (1984) and Travis (1984), Chomsky (1986a: 193) remarks that it is expected that the direction of Case marking by lexical categories in a language would be uniform, which in English would be to the right. Hence genitive would be assigned to the right in English. To account for the Gen case in (21a) on the left of the noun and Gen case in (21b) on the right of the noun (marked by *of* insertion), inherent case-marking must distinguish case assignment under government at D-S and case realization also under government but at S-structure. "The realization of genitive Case depends on S-structure position" (Chomsky 1986a: 203).

Thus in (21c), at D-structure the N *destruction* governs and θ -marks the NP *the city*, and inherently case marks the NP *the city*, and GEN case is assigned on its right. At S-structure, the N *destruction* governs the complement in (21b) and the subject in (21a); and GEN case is

¹²Chomsky (1986a: 194) suggests that GEN case realization (*of* in complement position, POSS in subject position) is part of the periphery in English. The rule of *of*-insertion is part of the grammar's periphery since its insertion is restricted as shown in the examples (see p. 191).

(i) *the belief [α John to be the winner] (C (264i))
 (ii) *the belief [of John to be the winner] (C (266))
 (iii) *there was [_{VP} killed (of) John] (C (267i))

realized morphologically by *of*-insertion on the complement or POSS-insertion on the subject position. POSS is inserted in the context in (23).

(23) [_{NP} NP ___] (C 1986a: 195)

"The possessive element POSS is affixed to the subject of an NP, serving as the realization of Case for the NP to which it is affixed" (p. 188).

POSS insertion does not apply to Adj as in (22a) but it can apply to gerunds as in (24).

(24) a. [John's reading the book] disturbed me (C 1986a: (275ii))

b. John's having been appointed (C 1986a: p. 195)

It is further pointed out that movement to the subject position for Case realization by POSS insertion is restricted (i) to a complement of a N as in (21a) and (ii) to the internal argument of a passive gerund as in (24b).

Though Case realization can be to the left through POSS insertion or to the right through *of*-insertion, there is uniform marking of inherent Case by associating inherent Case and θ -marking as expressed in the Uniformity Condition in (25) (see Chomsky 1986a: (272)).

(25) Uniformity Condition: If α is an inherent Case-marker, then α Case-marks NP iff α θ -marks the chain headed by NP.

So far the Uniformity Condition could be described as an S-Structure filter to ensure that a θ -marked NP can get inherent Case, and it was formulated to explain complements with Gen Case being either *in situ* or moved to the specifier position. However the UC is also used to explain Gen Case through POSS assignment on NPs that could not have been generated as complements. In (26a) and (27a), *John* gets a possessional semantic role in the specifier structural position from the N and inherent genitive case is assigned to *John* which is realized by POSS insertion by the UC in (25). In (26b) and (27b), *John* gets an agent semantic role and inherent genitive case

which is realized by POSS insertion by the UC in (25). "There are various controversial questions about these structures [(26)]; let us assume that they are settled in such a way as to satisfy the uniformity condition" (Chomsky 1986a: 195) (see also footnote 6).

(26) a. [John's story] disturbed me (C 1986a: eg. (275i))

b. [John's reading the book] disturbed me (C 1986a: eg. (275ii))

(27) a. John's reconstruction(s) of an 18th-century village (C 1986a: eg. (276i))

b. John's reconstruction of the crime (C 1986a: eg. (276ii))

The important issue dealt with so far is how Case is assigned. Case is assigned under government. Structural Case is assigned at S-Structure by V or by Agr in INFL. Inherent Case is assigned at D-Structure by N or Adj (or gerunds) to an NP to which it assigns a semantic role. Inherent Case is realized at S-S either as POSS insertion to a specifier position or as *of*-insertion to a complement position. So a tangential issue that was raised is what is case marked, the NP itself or the position.

Inherent Case is marked on the NP and not on the position (for discussion see Chomsky 1986a: 199). Whether one considers assignment at D-Structure or realization at S-Structure, both involve marking the NP and not the position. First, at D-Structure Case assignment is to the NP itself and not to the position of the NP. For example in (28), Case is assigned at D-S to the NP *the city* and moves with the NP. If Case were assigned at D-S to the NP position and remained on *e* when the NP moves, then in the CHAIN [the city, *e*] the last element would be case marked violating the last resort idea that an NP moves to get Case. (That is, for any CHAIN $C=(\alpha_1, \dots, \alpha_n)$, α_1 is case-marked.)

(28) [_{NP} the city][_N destruction *e*]

Second, Case realization is on the NP where it is at S-Structure.

In summary, case was not assigned in only one type of syntactic configuration. Structural cases were assigned at S-Structure and inherent cases were realized at S-Structure. Nom case was assigned by Agr in Infl to its specifier under government in a Spec-head relationship, and structural Acc case was assigned by the V by governing its complement. Inherent Gen case was realized at S-Structure on an NP assigned a θ -role, satisfying the Uniformity Condition. Although V assigns a theta-role to its complement and assigns Acc, Acc was considered structural and not inherent case. Gen case was described as being assigned at D-Structure to the right, but it also seems it would have to be assigned to the left for possessor and agent subjects which would not be generated on the right. Recall that Chomsky (1986a: 195) describes the structures with possessor and agent Gen subjects as controversial with respect to case assignment, and that satisfying the Uniformity Condition is what matters. The Uniformity Condition appears to act like a Case Filter to ensure that if an NP is assigned a θ -role it can get case, which would be by the θ -role assigner.¹³

The next section describes the effect on the assignment of case with the introduction of functional projections AgrP and DP. These functional projections became the locus for case assignment in a Spec-head relation when the lexical head moved to the functional head and the argument moved to the Spec of the functional projection.

¹³For a discussion of the Uniformity Condition, see Webelhuth (1995). The UC is usually referred to as an NP being marked with case so that its θ role is visible.

1.3 Case Assignment and Modified Syntactic Structure

The maximal projections used in Chomsky (1986a: 161) are shown in (29).

(29) a. [_C COMP [_S NP [_{INFL} INFL [_{VP} V ...]]]]

b. [_{NP} DET [_{N'} N ...]]

INFL, the head of the sentence, contained the two features: tense and agreement. Inflection was subsequently split into two nodes--one for tense and one for agreement, with agreement dominating VP (Pollock (1989)). Chomsky (1989), citing manuscripts by Pollock (1988) and by Kayne (1988) on past participle agreement in Romance languages, agreed that tense and agreement be split but suggested that morphological evidence shows there is a subject agreement node dominating the tense phrase. Thus Pollock's [_{TP} [_{AgrP} [_{VP}]]] should be [_{Agr(s)P} [_{TP} [_{Agr(o)P} [_{VP}]]]]. Structural case was then correlated with Agr and reflected a government relation between an NP and an Agr head (government being defined within an X^{MAX}). Nom case is associated with subject-verb agreement and is determined by the Spec-head relation as shown in (30a). Acc case is associated with object-verb agreement and is determined by the Spec-head relation as in (30b) or the (adjoined to AgrP)-head relation as in (30c).

(30) a. [_{AGR_sP} NP_i [_{AGR_s'} V_j Agr_s [_{TP} ...t_i t_j...]]]]

b. [_{AGR_oP} NP_i [_{AGR_o'} V_j Agr_o [_{VP} t_j t_i]]]]

c. [_{AGR_oP} NP_i [_{AGR_oP} [_{AGR_o'} V_j Agr_o [_{VP} t_j t_i]]]]]

This structure "would be assuming that AGR-O is present even for non-transitives" (Chomsky 1989: 57). Note however that objects, even if present, would not have to raise to AgrP at S-structure. For example in (31a) (Chomsky (1989) using examples from Kayne (1988)), the NP object in French does not raise and there is no agreement.

(31) a. Paul a repeint (*repeintes) les chaises

b. Paul les a repeintes

In (31b) the clitic in French raises to AgrP where there is government by Agr, and there is agreement. Thus there would still need to be Acc case assigned under government by a V to its complement.

Koopman and Sportiche (1991)¹⁴, describing the structural cases of Nom and Acc, distinguish "case assignment by agreement" which is a Spec-head relation from case assignment under government. Their definition of government (1991: 229-230) refers to the minimal first branching node, so that a head X can govern its complement YP but not the specifier of XP. There is parametric variation in case assigners so that both Nom and Acc could be assigned under the reflex of agreement or under government. A language does not have to choose either case by agreement or case under government. For example, in Dutch postpositions are agreement case assigners and prepositions are governor case assigners. Nom does not have to be assigned in a Spec-head relation. In English there is subject-verb agreement and Nom is assigned by agreement. Irish and Welsh have VSO word order, and the V (i.e., V+I) does not agree with the subject, and if aspect or negation is present the subject moves past them to be adjacent to (V+I). Thus in Irish and Welsh Nom case is assigned under government.

The discussion so far has related an expansion of the functional projections of VP, in particular the splitting of IP into Agr_SP, TP and Agr_OP, to the effect on the assignment of the structural cases Nom and Acc. Nom could be a reflex of Spec-head agreement between the

¹⁴In Koopman and Sportiche (1991) the IP node dominates the VP, rather than IP being split into an AgrP and a TP. Since their focus is the position of subjects, the node label is not relevant in their discussion of case which also focuses on Nom case.

subject which has moved to [Spec, Agr_SP] and the head Agr_S as in English; or Nom could be assigned by the head Agr_S to its complement (the subject has moved to Spec position of its complement) and there would be no agreement as in Irish and Welsh. Acc could be a reflex of Spec-head agreement between the object which has moved to Agr_OP with object-verb agreement as with French object clitics; or Acc could be assigned by V to its complement and there would be no agreement as in French object NPs and in English.¹⁵

The NP projection was also expanded to be headed by a DP functional projection (cf. Hellen (1986), Fukui and Speas (1986), Abney (1987), Lobeck(1991)) as shown in (32a). The Det(eterminer) was no longer [Spec, NP] as shown in (29b) and repeated here as (32b), but now headed the DP.

(32) a. [_{DP} Spec [_D D [_{NP} Spec [_{N'} N]]]]

b. [_{NP} Det [_{N'} N]]

The structure in (32a) was further modified to include a higher functional projection KP (cf. Fukui and Speas (1986), Lamontagne and Travis (1987)). The NP projection as in (33a) now parallels the VP projection (abstracting away from the split of the IP) as in (33b).

(33) a. [_{KP} [_K K [_{DP} [_D D [_{NP} Spec [_{N'} N]]]]]]

b. [_{CP} [_C C [_{IP} [_I I [_{VP} Spec [_{V'} V]]]]]]

Mohammad describes the similarity between the IP and DP constructions (see also Valois (1991) for French and English). If the V moves to I, there is VSO word order and there is no agreement as the verb agrees with the expletive S generated in [Spec, IP]. If the I lowers to V,

¹⁵Note that another important change is the generation of subjects in a VP internal position, i.e., as [Spec, VP] (cf. Speas 1986, Zagana 1988).

there is SVO word order with agreement between the subject and verb. There are the same two parallels within the DP: N can raise to D, or D can lower to N. In the former there is Gen case marking on the subject adnominal as in the Arabic examples in (34).

- (34) a. *kitaab-u l-walad-i*
 book-NOM the-boy-GEN
 'the boy's book'
- b. *kitaab-u walad-in*
 book-NOM boy-GEN
 'a boy's book'

And in the latter, D lowers and cliticizes to the last member of the 'construct state' construction as shown in (35) where the definite article *ar-* has cliticized to the last NP.

- (35) *taawilat 9ammat zawjat ar-rajul*
 table-FEM aunt-FEM wife-FEM the-man
 'the man's wife's aunt's table'

In summary with the expansion of functional projections, case was assigned by the head of a functional category: Nom by Agr_S, Acc by Agr_O and Gen by D. For example, Waite (1994) describes, for Maori, the head D assigning Gen to the [Spec, NP] on its right, whether or not the head N moves to D. As noted earlier in the description of English there are two ways of assigning Gen: POSS assignment as in *the city's destruction* or *of*-insertion as in *the destruction of the city*. Other languages that have two ways of assigning Gen include, e.g., German as in *das Buch des Mannes* 'the man's book' and *das Lied von der Erde* 'the song of the earth', Hebrew (Ritter 1991), Norwegian (Taraldsen 1991), and Arabic (Mohammad 1988)¹⁶. One strategy involves the head N moving to D and D assigning Gen to its right. The second strategy does not move the head N to the DP, and has the N assigning Gen case. Other languages such as Inuktitut

¹⁶Ritter (1991) uses the two functional projections DP heading a Num(ber) P(hrase). Taraldsen (1991) does not label the highest functional projection, calling it XP. His XP dominates the DP which in turn dominates NP. Mohammad (1988) has only a DP dominating the NP. What they call their functional projections is not important for the discussion.

assign Gen (=Erg) to both adnominals (see Chapter 4).

In Section 1.2 it was the lexical head (V, I or N) that assigned case (though it was the Agr features in I that were considered to assign Nom). In this Section, with the addition of functional projections (AgrP and DP), it was the functional head (Agr or D) that assigned case. In the next section we will see the switch back to lexical heads, however, they check rather than assign the case. In the early Minimalist Program we will see that the lexical head moves to the functional head and, in a Spec-head relation, checks the case of the NP that has moved to the Spec of the functional projection. With the elimination of the Agr functional projections,¹⁷ the lexical head checks the case of the NP in a Spec-head relation in the TP or VP projections.

1.4 Case in the Minimalist Program

1.4.1 Early Minimalist Program

In the Minimalist Program (Chomsky 1992, 1994, 1995a; Lasnik 1993), a linguistic expression satisfies the two interface levels: articulatory-perceptual (PF, i.e., phonetic form) and conceptual-intentional (roughly equivalent to LF, logical form). D-structure and S-structure are no longer relevant levels, and head government is no longer applicable. The Case Filter becomes an interface condition at LF (Chomsky 1992: 14). The lexical items (LI) V and N are drawn from the lexicon, and are merged fully inflected (i.e., V with tense and agreement, and N with number and case) with other LIs into binary branching structures. Case is checked in a Spec-head

¹⁷Chomsky (1995a) is non-committal about the status of the DP as a functional projection.

relation either at Spell-out¹⁸ or in LF. Similar checking processes would also apply within a DP with case being checked internally. Chomsky (1992), (1995a) and Lasnik (1993) discuss the checking of the structural cases Nom and Acc, and Chomsky and Lasnik (1995a) maintain the distinction between Nom and Acc being structural and Gen being an inherent case. Gen is assigned by the [+N] feature in N and A, with *of*-insertion before the complement adnominal. Only if a θ -role is assigned can inherent (Gen) case be assigned as illustrated in their examples in (36).

(36) a. * my proof of John to be here (C & L: eg (292b))

b. my proof of the theorem (C & L: eg (295b))

In (36a) *proof* does not assign a θ -role to *John*, so cannot assign inherent case to *John*. But in (36b) *proof* assigns a θ -role to *theorem* and can assign Gen.

The structural cases Nom and Acc are checked in a Spec-head relation in the appropriate Agr projection. Agr and T are not lexical items but have N and V features that are erased when checked. The checking domain of a head X is illustrated¹⁹ in (37) where [] indicates items that could be checked by X (see the written description in Marantz 1995: 365).

¹⁸Spell-out is roughly equivalent to S-structure in GB (*Government and Binding*). Language is assumed to be derivational in the sense that language assembles (Chomsky 1995a), and Spell-out is the point in the derivations where the two levels, PF and LF, separate in the sense that what happens at one level does not affect the other level. In later refinements to the Minimalist Program, Chomsky (1995a) describes Case as being a [-Interpretable] feature which thus disappears at LF.

¹⁹The positions for checking Fs such as case on NPs were originally the same (a Spec-head relation) regardless of whether the checking was overt or covert. Later refinements to the Minimalist Program differentiate overt F checking as a Spec-head relation from covert F checking which involves adjunction of the Fs to the target head (see Chomsky 1995a: 271).

(37)

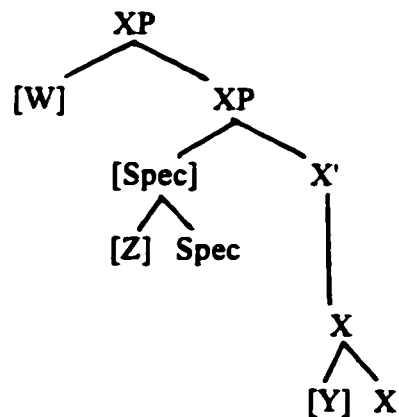

Strong features must be checked before PF. T adjoins to Agr_S ²⁰ and the NP subject moves to the specifier of Agr_S where the Nom case of the NP is checked by T in $[\text{Agr}_S \text{ T } \text{Agr}_S]$ in a Spec-head relation. Similarly V adjoins to Agr_O and the object NP moves to the specifier of Agr_O where the Acc case of the NP object is checked by V in $[\text{Agr}_O \text{ V } \text{Agr}_O]$ in a Spec-head relation. If the N features in Agr are strong the NP will move to $[\text{Spec}, \text{Agr}]$ at Spell-out for checking, while if V features in Agr are strong the V moves at Spell-out for checking. NP movement and V movement are independent, but note that T checks Nom case and V checks Acc case in functional projections.

An example illustrating case checking is in embedded clauses in Modern Greek. Subjects in embedded clauses can have Nom or Acc case, depending upon whether the embedded clause is [+ tense] or [- tense], with case being assigned by the embedded T or the matrix V respectively (Iatridou 1993). In [+ tense] clauses the subject NP moves to $[\text{Spec}, \text{Agr}_S]$ and T moves to Agr_S where T checks the case and Agr_S checks the nominal features. The subject in the [-tense] embedded clause (or an object NP in a matrix clause) moves to the matrix $[\text{Spec}, \text{Agr}_O]$ and V

²⁰Agr is just a collection of Φ -features, and the subscripts *S* and *O* in Agr_S and Agr_O are mnemonic devices to distinguish the higher AgrP associated with TP from the lower AgrP associated with VP.

moves to Agr_O where V checks the case and Agr_O checks the nominal features. The checking of case and the checking of nominal (agreement) features are distinct operations, though both occur in a Spec-head relation. For example in (38) the past participle is in a Spec-head agreement relation with the subject but the subject has Nom case from T in Agr_S.

(38) a. Ils sont battus

b. [Marie et Louise] sont venues

In the early minimalist papers (Chomsky (1992)), the lexicon is projected into binary branching trees, and the ordering of the functional projections [AGR_{SP} [TP [AGR_{OP} [VP]]]] is maintained. However in Chomsky (1994, 1995a) X-bar structure is no longer a given part of the structure that is there before a movement occurs; rather X-bar structure is built up through generalized transformations. Nevertheless Chomsky (1994) still assumes that there are two agreement heads separated by tense, that is, [Agr_S [T [Agr_O [...]]]]. Thus there are two agreement heads and which agreement head is active²¹ determines the difference between Nom-Acc and Erg-Abs languages (Chomsky 1992, 1993, Bobaljik 1993). If Agr_S is active, the single NP will have similar case and agreement properties to the subject of transitive clauses, i.e., it will be a Nom-Acc language. If Agr_O is active, the single NP in intransitive sentences will have Abs agreement like the object in transitive clauses, i.e., the language will be Erg-Abs.

This parameter is based on the idea that only crossing paths from movement of NPs to check case is allowed in language. The argument in Chomsky (1993: 18-19) is that both the subject and object are in the same minimal domain and equidistant to Agr_O; so either the subject

²¹ This parameter is discussed, and rejected, in Chapter 3 Section 3.2. It is also discussed in Sections 1.4.2 and 1.4.3.

or object could move to [Spec, Agr_O], but only the object does. If subj → [Spec, Agr_O] as in (39a), the wrong derivation obtains. Suppose subj → [Spec, Agr_O] and V → Agr_O. A Chain (V, t_v) is formed with the minimal domain {subj, t_s, obj}. But the object can't raise since the subject in [Spec, Agr_O] is already there blocking the movement, so the object would have to raise to [Spec, T] or the higher AgrP. If [_{AGR} V Agr] → T (or Agr_S), a Chain (V, t_v', t_v) is formed with the new minimal domain which doesn't include t_s or object. Thus the object can't move and is "frozen in place". Hence the object must move to [Spec, Agr_O] as in (39b) where V → Agr_O and obj → [Spec, Agr]. The Chain (V, t_v) is formed with the minimal domain {obj, subj, t_o}. The subject and object are equidistant and the subject can move to [Spec, T].

(39) a. Wrong derivation (Nested Paths)

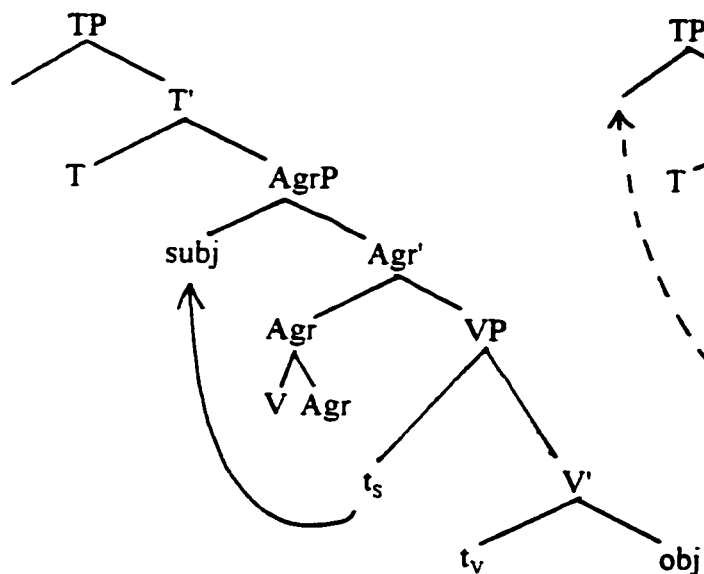

b. Correct derivation (Crossing Paths)

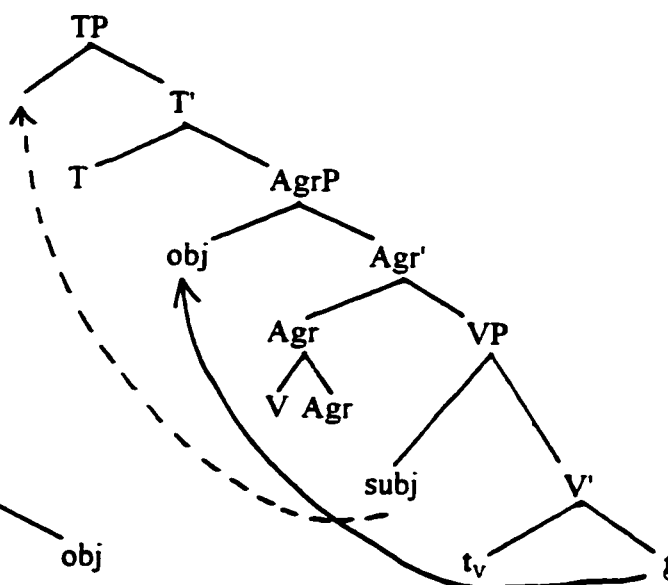

Thus a crossing path produced by movement of the subject and object NPs for checking is the only permissible option in language. Since the case of the subject is checked by T in Agr_S and the case of the object by V in Agr_O, Nom and Erg subjects are associated with T/Agr_S and Acc and Abs objects with V/Agr_O as in (40).

(40)		Accusative	Ergative
	T (Agr _S)	Nom	Erg(=Gen)
	V (Agr _O)	Acc	Abs(=Nom)

In accusative languages the only argument in intransitive sentences has Nom while in ergative languages it has Abs, a parameter is formulated to account for this difference and is given informally in (41).

(41) In accusative languages Agr_S is "active" while in ergative languages Agr_O is "active".

1.4.2 Later Minimalist Program

The major change in the Minimalist Program in Chomsky (1995a: Section 4.10) is the elimination of Agr functional projections. This section describes how case is checked without an AgrP. Although Chomsky did not consider the effect on the parameter just described, where accusative languages have an "active" Agr_S while ergative languages have an "active" Agr_O, this section also considers the effect of the loss of Agr projections on this parameter.

An important idea in the Minimalist Program is procrastination,²² that is, "Delay performing a necessary operation until LF, except to prevent a PF violation" (Lasnik 1993: 8). Since morphological features are the driving force of movement, strong features will need to be checked at Spell-out, while weak features need not be checked until LF. This difference between overt and covert feature checking is manifest in different types of movement possible for

²²Earlier computational principles (greed, procrastinate, shortest move, shortest derivation, economy) are really just descriptive properties of the language. These principles involved a sense of 'look ahead' and an evaluation of competing derivations, but these principles are no longer needed. 'Look ahead' and 'evaluate derivations' are avoided and the properties of language that these computational principles expressed are by-products of either Attract/Move or of the morphological properties of heads. (From a talk by Chomsky, the invited speaker at NELS, Harvard/MIT, Oct. 27-29, 1995.)

checking (see note 19). Overt checking pied pipes along enough material for convergence at PF and can be either adjunction of a head to another head or movement of an XP forming a specifier position.²³ For example, the subject moves to [Spec, T] and T checks Nom case. Covert checking involves movement only of formal features (FF) as illustrated in (42).

(42)

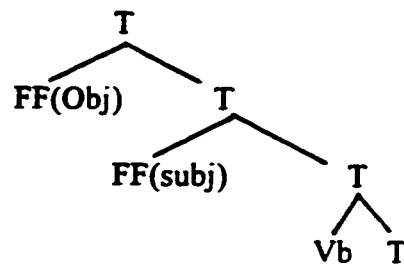

The case of both the subject and object are checked at LF: FF(Nom) by T and FF(Acc) by Vb.

Whereas Fs on arguments (e.g., case) require movement for checking, Fs on non-arguments can be checked *in situ* as in (43) (examples from Chomsky 1995a: 311)

(43) a. I wonder [_{CP} whether Q [he left yet]]

b. I wonder [_{CP} [_Q if Q [he left yet]]]

c. there is a book on the table

Merging of the feature Q in (43a) and (43b) creates a checking domain whereby *whether* and *if* can satisfy the strong Fs of Q in their base positions. In (43c) the expletive *there* is merged with T as [Spec, T] and, in this base position, satisfies the strong EPP (Extended Projection Feature) feature of T.

Chomsky generally considers the strong Fs as being on a target which is functional (1995a: 232). Although he says (1995a: 266) that the strong F causing the movement can be on

²³Multiple specifiers are allowed which permits the head to check the same case repeatedly. This is observed with Gen case in Japanese (see Section 1.4.4), and with Erg/Gen in Inuktitut (see Chapter 4).

the target or on the element moved, he concludes (p. 378-9) by saying that there is "no reason to suppose that N or V, the basic substantive categories, have strong features. The strength property can be restricted, perhaps, to the nonsubstantive elements T and v that head the major projections within the clause, and to complementizers that serve as mood-force indicators."

A lexical entry (LI) contains intrinsic features such as category (N, V) and [\pm animate]. Optional features such as case and number for N and Φ -features and tense for V are added either in the numeration (N, i) for the LI or when it is selected (Chomsky 1995a: 236). The object is

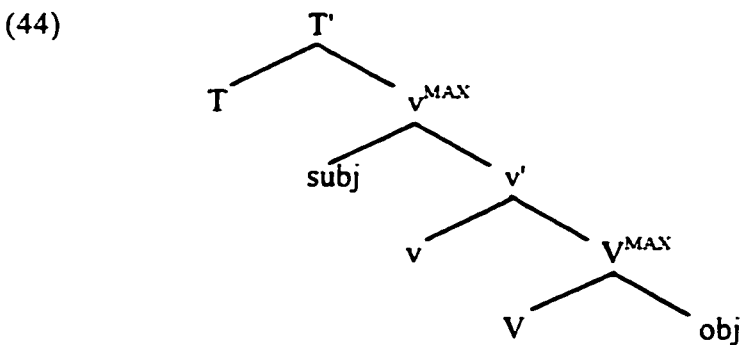

selected with Acc and Merges with the V, the V projecting to V^{MAX}. A light verb²⁴ v is selected

²⁴Chomsky generates the VP as a Larsonian shell for transitive and unergative verbs (1995a: Section 4.6). The external argument is assigned a causative/agent role by the combined v-VP. [Spec, v] "just is an external θ -role" (p. 347). Adjunction of V into v "is permissible if the target v is a light verb requiring a verbal affix. Independently, these conclusions are required by the properties of θ -theory discussed earlier" [i.e., v-VP assigns agent θ -role to external argument] (p. 321).

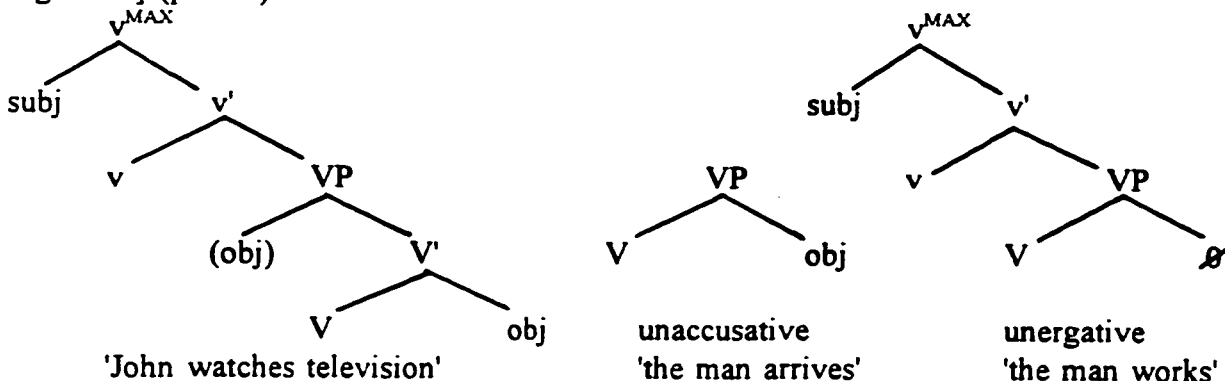

and Merged with V^{MAX} , with v projecting. The subject is selected with Nom and Merges with the v , v projecting to v^{MAX} . T is selected and Merges with v^{MAX} resulting in the structure in (44) for a sentence such as *John watches television*.

Case checking in an accusative language like English, where the subject is checked overtly and the object covertly, proceeds as follows. T has a strong EPP feature (or the subject has a strong Nom feature) that requires overt checking. Conditions on Chain (CH) formation and the Minimal Link Condition (MLC) are part of the definition of movement, and hence must be satisfied with Move/Attract of the subject to T. The CH conditions are given in (45) and the MLC in (46).

(45) Conditions on Chains (Chomsky 1995a: 253-254)

Movement for F checking must satisfy the following three CH conditions: (i) movement is driven to check a morphological property, (ii) a CH (NP, t_{NP}) is formed in which NP c-commands its trace, and (iii) the CH is uniform with respect to phrase structure status (i.e., all members of a CH are either X or XP).

(46) Minimal Link Condition (Chomsky 1995a: 311)

K attracts α only if there is no β , β closer to K than α , such that K attracts β .

The subject is attracted to T and enters a Spec-head checking relation with T as in (47). This movement satisfies the CH conditions in (45): movement is driven to check strong EPP feature in T (or strong Nom feature in NP); the head of the chain (subject) c-commands its trace; both members of the CH are XPs. It also satisfies the MLC in that the subject is closest to T; the object is either in a different domain from the subject (if V has not moved up to v), or if V has moved to v forming Vb ($=[V v]$), then both subject and object are in the same domain and equally close to T except the object has Acc feature which could not enter into a checking relation with T and the MLC would be violated since the subject is equally close but has Nom.

(47)

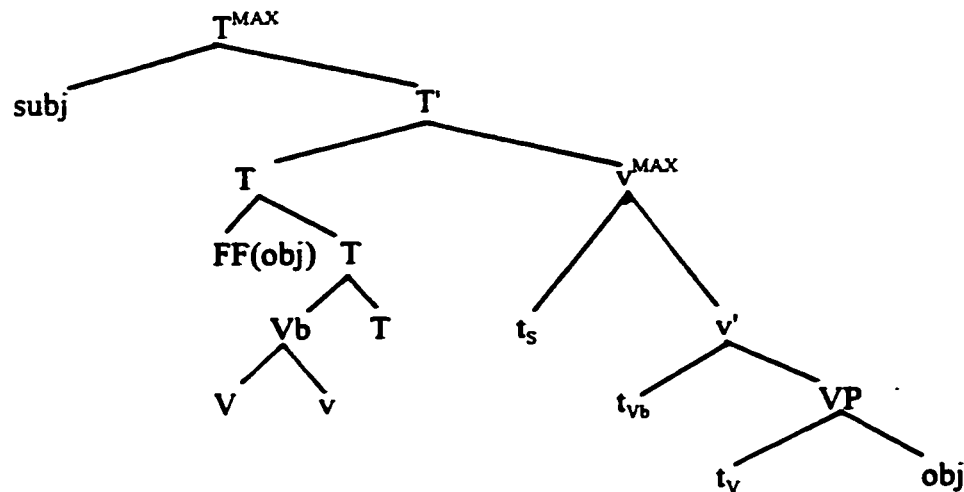

It must be the subject that moves to [Spec, T]. Suppose the object were to move to [Spec, v^{MAX}] checking Acc, then move to [Spec, T] checking EPP of T, and the subject were to move to [Spec, T] checking Nom. This should be okay since multiple specifiers are allowed, and when $V \rightarrow v$ forming [_v V v] both the subject and object are in the same domain and equidistant to the target. This however violates rules of economy since there are three steps in the derivation which means 3 violations of Procrastinate, while the alternative derivation in which the object moves to [Spec, v^{MAX}] checking Acc and the subject moves to [Spec, T] checking Nom and EPP involves only two steps and hence only two violations of Procrastinate. (See Chomsky 1995a: 357). So the subject moves to [Spec, T] checking Nom and EPP features and these two features on T are erased.

It is assumed that V raises overtly to v forming $Vb=[_v V v]$. In French where the Vb moves overtly to T and Acc is checked covertly, the FF(obj) adjoins to T at LF and Vb checks Acc. In languages like English where the Vb only checks its Fs at LF, it is not clear whether Acc case on the object is checked by adjoining the FF(obj) to T at LF as with French, or Acc is checked by adjoining FF(obj) to Vb at LF before Vb adjoins to T.

Section 1.4.1 mentioned a parameter for explaining the difference between accusative and ergative languages based on the existence of Agr projections, i.e., in accusative languages Agr_s is active and in ergative languages Agr_o is active. Now that AgrP is no longer part of the structure, is the parameter still valid? Given the Larsonian shell and $V \rightarrow v$, the subject and object are in the same minimal domain of the CH ($V-v, t_v$). The $obj \rightarrow [Spec, v]$ as in (48) since multiple specifiers are allowed. The object and subject are still in the same minimal domain and equidistant to T, so $subj \rightarrow [Spec, T]$, resulting in the expected crossing paths. There is the same account of T and V checking case as in (39b), i.e., T checks the case of the subject and V checks the case of the object.

(48)

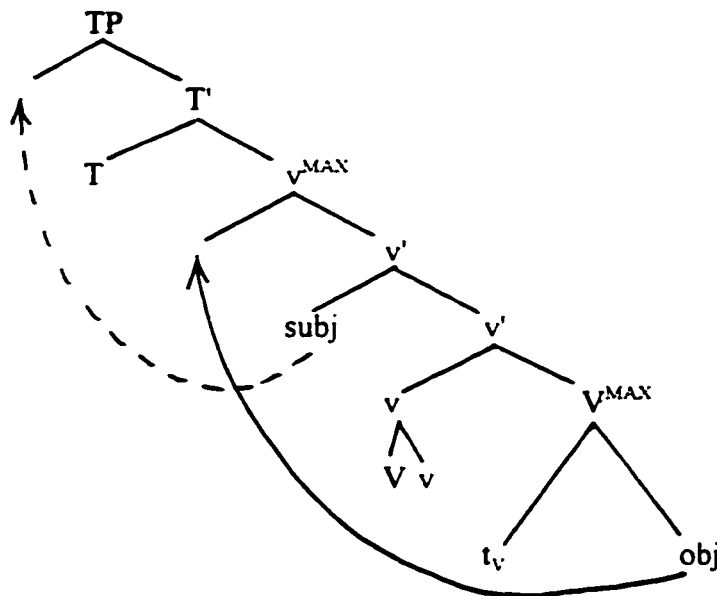

However the parameter cannot be expressed in terms of which Agr is "active". The only way to express the case on the sole argument in intransitive sentences would be to say that in accusative languages T is "active" while in ergative languages V is "active" or T is "NOT active".

The next section will account for ergative case marking within the Minimalist Program, and in the process eliminate some of the stipulations that have been made.

1.4.3 Abs (=Nom) Objects in the Minimalist Program

In the Minimalist Program movement must be for checking and satisfy the CH conditions and the MLC. We also saw that feature checking could take place *in situ* as in (43) with the Q and EPP features. With respect to F-checking taking place *in situ* in (43), Chomsky (1995a: 311-312) stipulated that arguments must move to have their Fs checked, otherwise the subject *in situ* would be checking the case F of the verb and the subject would have to be Acc. In this section I show that a Minimalist Program account of case marking in accusative languages can also apply to ergative languages, and I show that the stipulation (that arguments have their case feature checked when the argument heads a nontrivial chain) is not required.

In earlier VP structures (and the VP-internal subject hypothesis) the subject and object were in the same minimal domain. With the Larsonian shell that Chomsky adopts in (1995a), $V \rightarrow v$, thus the subject and object will also be in the same minimal domain. Therefore I will not use the extra structure in Larsonian shells posited for transitive and unergative verbs. Section 1.4.2 explained how a transitive sentence in accusative languages is derived in the Minimalist Program. Figure (49a) illustrates how a transitive sentence in ergative languages is derived.

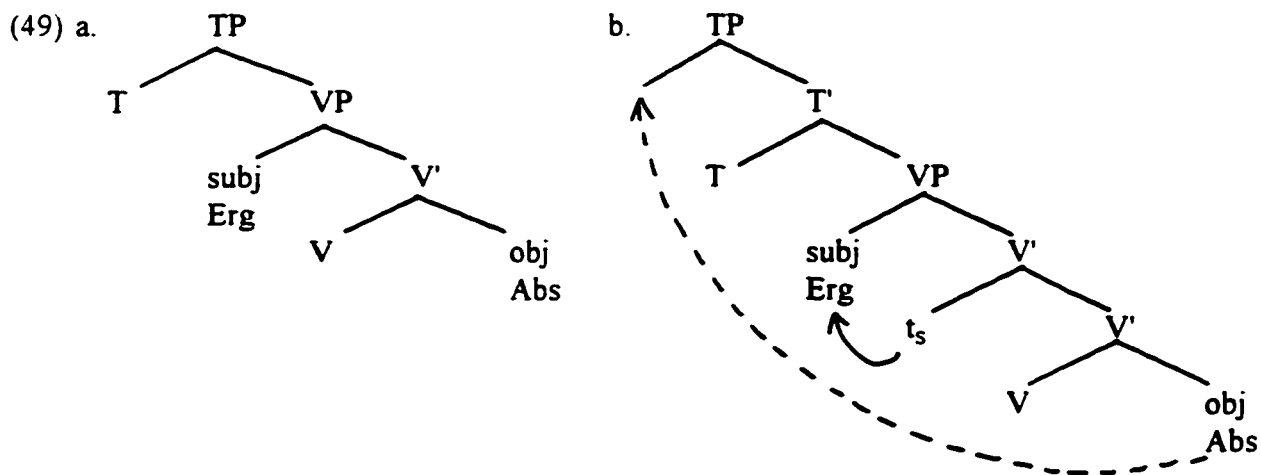

In ergative languages, the object is selected with Abs case and merges with the V; the subject

is selected with Erg and merges with the VP; T is selected and merges with VP and T projects.

Figure (49b) illustrates feature checking for ergative languages. If we assume that arguments must move to have their Fs checked, then the subj \rightarrow [Spec, V] and checks F(Erg) against the F(Erg) in the verb. This movement is permissible since it satisfies the CH conditions (movement for morphological checking, NP_s c-commands its trace, CH is uniform) and the MLC (there is no closer NP that has the F to be checked by V). In (49b) both the subject and object are in the same minimal domain {subj, t_s, object} and hence equidistant from T. Thus the obj \rightarrow [Spec, T] where it checks Abs/Nom case and the EPP feature of T. The Erg subject could only block T from attracting the Abs object if the subject had a F that needed to enter a checking relation with T, which it doesn't.

The movement of the subject to a second specifier of V and of the object to the Spec, T may look like "a nested path". However I suggest that it isn't really and that the subject does not need to move to check its case F as it can do so *in situ* since the subject is already in a Spec-head relation. There is only one movement, that of the object. Chomsky (1995a) assumed that if the subject was checked by V it would have to have Acc case and if the object was checked by T it would have to have Nom case (see, for example, p. 309, p. 371). In order to prevent the subject, which was already in a Spec-head checking relation with V, from checking the case feature of the V, Chomsky stipulated that the subject must move to check its case (i.e., that it needs to head a nontrivial chain) (see pp. 311-312, 352-354, 369). Thus this stipulation (Chomsky 1995a: 311-312) that Merge can allow F-checking of non-arguments while Attract/Move is required for F-checking of arguments is unnecessary. Strong features need to be checked and if they are not in a checking relation then Attract/Move will take place.

The difference between accusative and ergative languages can be accounted for by which head checks the case of the subject and object, and Chapters 1 and 2 show why this does not need to be stated as a parameter. In Acc languages the Acc object is checked by the V, but in ergative languages the Abs (=Nom) object is checked by T. This is because the Abs object has a strong F that must be checked by Spell-out, whereas it need not be checked until LF in accusative languages. Chapter 2 explains why an object is selected with Abs (=Nom) case and why it would carry a strong F.

This description followed Chomsky (1995a) in adding Case (and other optional Fs) in the selection (or numeration) of LIs before they merge. Thus for Abs/Nom-Inst/Acc sentences in ergative languages as in (3b), repeated here as (50), the object would be selected with Inst/Acc case when it is merged with the V, and the subject with Abs/Nom when it merges with V^{MAX}.

(50) anguti tuktu.mik taku.juq
 man(Abs/Nom) caribou.Inst/Acc see.IND3A
 'the man sees a caribou'

This explanation, however, does not distinguish obliques from structural cases as both would be selected with case when merging takes place. By looking at proposals about case by Libert (1994), Miyagawa (1993) and Bittner (1994a), and combining this with the case marking patterns in ergative languages, I will suggest a refinement as to where an argument is marked with case.²⁵

Libert, Miyagawa and Bittner all consider Gen/Erg to be a structural case. Libert makes a distinction between syntactic and semantic case and asks (1992: 64-72) whether the structural

²⁵Chomsky (1995a: 275) notes that the Minimalist Program assumes that Case and optional Φ features are added in numeration (N, i) or selection, and that it would not cause complications for the Minimalist Program if some case and Φ features are separate LIs with their own projection. Based on Korean data, Yoon (1994) argues for syntax building up inflection rather than a fully inflected lexical item selected and features (tense, aspect, mood) checked.

vs. inherent case distinction in Chomsky (1981, 1986a) is the same as his syntactic vs. semantic distinction. He concludes that they do not correspond for three main reasons. First, structural case is supposedly assigned in certain structural positions, yet, for example, Gen case which is assigned in the structural position [Spec, NP] is described as an inherent case. (Although note that Chomsky (1981) considered Gen as a structural case.) Second, structural case is supposed to be dissociated from θ role assignment, yet a V assigns both a θ role and Acc case to its complement and Acc is considered a structural case. Third, structural vs. inherent case is supposed to differ according to the level at which case is assigned: S-structure for structural case and D-structure for inherent case. Since it may not be possible to distinguish at which level case is assigned, Libert feels this is not a useful criterion to distinguish structural vs. inherent case for comparison to his distinction. As we saw in the Minimalist Program in Section 1.4, both structural cases Nom and Acc involve case checking in a Spec-head relation,²⁶ so Libert's hesitation to equate structural with syntactic case and inherent with semantic case no longer holds and we will assume that structural=syntactic case and inherent=semantic case. Libert uses syntactic tests to distinguish syntactic from semantic case and concludes that Nom and Acc are always syntactic as are some Gen, Dat and Inst cases. Gen subjects of NPs and gerunds, object argument genitives, and Dat and Inst causees are syntactic cases, while other Gen (including possessors), Dat (including Dat experiencers) and Inst are semantic. This grouping of Nom, Acc and Gen (Erg) as syntactic (=structural) cases corresponds with my analysis where Nom, Acc and Erg (Gen) are structural cases checked in a Spec-head relation.

²⁶Though if checking is covert only the formal features of the NP adjoin to the head T or V for checking.

Miyagawa (1993) describes Nom and Acc cases in Japanese as being checked at Spell-out and Gen NPs as moving to [Spec, D] at LF for case checking. Miyagawa's analysis of the *ga/no* conversion shows that the Gen NP in Japanese²⁷ behaves as the structural cases and moves to have its case checked in a Spec-head relation in DP at LF. The Gen subject is *in situ* as in (51a) and not as in (51b) where the Gen subject has raised since an S-adverb can occur to the left of the Gen subject as in (51c). Miyagawa (1993: 216) therefore assumes that all genitive phrase raising occurs at LF.

(51) a. $[_{DP} [_{IP} \text{John-no tabeta}] \text{piza}]$ (Mi: eg. 3)
 $[_{DP} [_{IP} \text{John-Gen ate}] \text{pizza}]$
 'the pizza John ate'

b. $*[_{DP} \text{John}_i\text{-no} [_{IP} t_i \text{ tabeta}] \text{piza}]$ (Mi: eg. 5)

c. $[_{DP} [_{IP} (\text{kinoo}) [\text{John-ka Mary}]\text{-no kita}] \text{riyuu}]\text{-o osiete}$ (Mi: eg. 13)
 $[_{DP} [_{IP} (\text{yesterday}) [\text{John-or Mary}]\text{-Gen came}] \text{reason}]\text{-Acc tell me}$
 'Tell me the reason why John or Mary came (yesterday)'
 reason \rangle [John or Mary]; [John or Mary] \rangle reason

The evidence that the Gen NP moves at LF to check its case is based on asymmetries in scope readings with Nom vs Gen subjects in complex NPs²⁸ as in (51c), and on movement constraints of objects. The Gen subject in (51c) can take wide or narrow scope over the head noun *reason* with the former being the preferred reading; however, if the subject were Nom,

²⁷In Japanese there is no agreement and case is marked on NPs with case markers/postpositions: *ga* for nominative, *o* for accusative, *ni* for dative, *no* for genitive, *wa* for topic.

²⁸The complex NPs that Miyagawa (1993) uses as evidence are not the same as complex NPs where the head of the relative clause corresponds to an argument position. In the latter there is Op(erator) movement and the Nom subject can have wide or narrow scope.

$[_{DP} [_{CP} \text{Op}_i [[_{IP} \text{John-ka Mary}]\text{-ga} t_i \text{ katta}]] \text{hon.}]\text{-o misete}$ (Mi eg. (21))
 $[_{DP} [_{CP} \text{Op}_i [[_{IP} \text{John-or Mary}]\text{-Nom} t_i \text{ bought}]] \text{book.}]\text{-Acc show me}$
 'Show me the book that John or Mary bought'
 book \rangle John or Mary; John or Mary \rangle book

[John-ka Mary]-ga, it would be able to take only narrow scope with respect to the head N (see Miyagawa 1993: 217, eg. (12)). Scrambling an object *[John-ka Mary]-o* to the front of a relative clause with a Nom subject (see p. 221 eg. (17)) gives only the narrow scope reading; so the Gen subject must have moved outside IP at LF and into DP to take wide scope. When the complex NP contains negation and a quantifier subject, the quantifier subject with Nom case can only be interpreted as within the scope of negation (see p. 227 eg. (37)). However when the quantifier subject has Gen case (see p. 227 eg. (38)), the quantifier can take wide scope or narrow scope with respect to negation.

In the stative construction, the object as well as the subject can have the *ga/no* conversion. If the object has Gen case, it cannot move outside the IP if the subject has Nom case since the subject would locally c-command its trace (see Miyagawa, eg. (44)). In complex NPs with Acc objects, the Acc object cannot scramble past a Gen subject since the Gen subject is in the original [Spec, V] position; however, the Acc object can scramble across a Nom subject (see p. 239, eg. (62) and (64)). And a Gen object also cannot scramble past a Gen subject (see p. 246, eg. (79)).

Thus Gen is a structural case according to Miyagawa (1993) as well as to Libert (1994). Bittner (1994a) also treats Nom (Abs), Erg (Gen) and Acc as structural cases, distinguishing them from inherent cases. Bittner further distinguishes Nom from Erg and Acc, with Nom being an unmarked structural case and Erg and Acc being assigned²⁹ marked structural case; and has arguments with inherent case (obliques) semantically selected, i.e., selected marked with case.

²⁹Bittner has the marked structural cases Erg (Gen) and Acc assigned case in a "case-binding configuration". This is discussed in Chapter 3, Section 3.4 and Chapter 4, Section 4.4.4. The "case-binding configuration" approach is rejected because it is unduly complicated and does not account for the data as well as the approach in my study.

However we must account for why Chomsky (1995a) and Chomsky and Lasnik (1995) would consider Gen to be an inherent case, and why Abs is universally almost always unmarked (Dixon (1994), Blake (1994)). By looking at local Spec-head checking relationships within a Minimalist Framework, there is an explanation. Obliques are semantically selected, i.e., selected with their case. Other arguments would be selected without case. In ergative languages if the object is marked with a [+specific] feature it would have a strong F that must be checked at Spell-out. This F requires wide scope and hence checking outside the VP which would be in the T projection. The subject remains in a local Spec-head checking relation with V. In accusative languages [+specific] is not a strong feature and the object remains inside the VP and can enter a local Spec-head relation with V. The subject would move to the T projection to check the strong EPP feature of T. What we see then is that the structural cases Erg and Acc are local to the VP lexical projection. An argument that enters a Spec-head relation with T is assigned unmarked Nom/Abs case. The intuitive difference between Nom and Acc being called structural versus Gen inherent is that both Nom and Acc need to move from their base argument positions for case assignment/checking, whereas a Gen argument can have its case assigned *in situ* since it is already in a Spec-head relation. In ergative languages when the object is not marked with a [+specific] feature it remains inside the VP and is assigned Acc. The subject moves to the T projection to check the strong EPP feature of T. The case on the non-specific object, however, is slightly different from Acc in accusative languages since it is not assigned in a Spec-head relation with V but is assigned with the "dummy" case marker *-mik*.

In summary, I suggest that LIs that are arguments are selected with case if they are

oblique, and without case otherwise.³⁰ In the selection the speaker marks an object as [+specific] if he intends to pick out a particular entity. This F requires checking. In ergative languages this F is strong and so is checked at Spell-out by moving to the T projection. In accusative languages this F is not strong and thus is not checked until LF. Arguments that remain in the VP are assigned case inside the VP: Erg/Gen to the subject and Acc/Inst to the object.

1.5 Application to Inuktitut

It was noted in Section 1.1 examples (5) and (6), repeated here as (52) and (53), that in Inuktitut the same case marker, *-up*, is used to mark a Gen NP and an Erg NP, and that the agreement patterns are the same.

(52) a. *anguti.up tuku taku.janga*

man.Erg/Gen caribou(Abs/Nom) see.IND3E/3A
'the/a man saw the caribou'

b. *Maali.up anaana.nga* (S I: p. 60)

Molly.Gen/Erg mother.3POSS(Abs/Nom)
'Molly's mother'

c. [*Taami.up qukiuti.nga*] *qai.jjuti.laur.tara* (S II: p. 8)

[Tommy.Erg/Gen rifle.3POSS(Abs/Nom)] come.BEN.PAST.IND1E/3A
'I came for Tommy's rifle (with that in mind)'

(53) a. [*anaanakkuti.vut*] *nagligi.vavut* (S I: p. 57)

[parents.1plPOSS(Abs/Nom)] love.IND1plE/3plA
'we love our parents'

b. [*qimmi.vut*] *quinijukulu.u.lir.tut* (S I: p. 57)

[dog.(pl)1plPOSS(Abs/Nom)] pleasingly-and-healthily-fat.be.state.IND3plA
'our dogs are pleasingly and healthily fat'

³⁰Bitner (1995a) has obliques/inherent case semantically selected with case specified, but the marked structural cases Erg and Acc are selected with an empty case head which is filled in in a case-binding configuration. The unmarked structural case Nom (Abs) is not really a case at all, but is selected as a NP/DP that is not case bound.

It was also noted that the term Gen could have just as easily been used to refer to the NP with Erg case, that is, to the subject of the transitive verb. In both the English and Japanese examples we see precisely this--Gen is the case term used to refer to the subject/possessor of an N as in (54), and to the *in situ* subject of a V as in the English gerund in (55a) and in the Japanese complex NP in (55b).

(54) a. John's book

- b. [_{DP} Hanako-no suugaku-no benkyoo] (Mi: eg. 79a)
 [_{DP} Hanako-Gen math-Gen studying]
 'Hanako's studying of math'

(55) a. [John's reading the book] disturbed me

- b. [_{DP} [_{IP} Taroo-no nama-de tabeta] sakana]-wa maguro da (Mi: eg. 7)
 [_{DP} [_{IP} Taro-Gen raw ate] fish]-Top tuna is
 'The fish that Taro ate raw is tuna'

Thus we will assume that in Inuktitut Erg and Gen are the same structural case. Dixon (1994) mentions Lak (North-East Caucasian family) and Ladakhi (Tibeto-Burman family) as other languages where Erg and Gen are the same case.

In Inuktitut there are four main mood phrases (declarative *-v/p-* (indicative) or *-j/t-* (participative), optative, and interrogative *-v/p-*) and five subordinate mood phrases (becauseative *-ga-*, conditional *-gu-*, dubitative *-mangaaq-*, frequentive *-jaraanga-*, and participial *-lu-*, *-&u-*) (cf. Mallon 1991, Dorais 1988). These mood phrase markers follow negation and are immediately followed by the agreement morphemes as in (56) where the mood is in boldface. I will assume that it is the mood head that checks Abs/Nom case of its specifier, but will refer

to it as T.³¹

(56) a. *ivvi.u.jariaksaq isuma.gi.lau.nngit.tara* (S II: p. 89)
you.be.that thought.have-as.PAST.NEG.IND1E/3A
'I didn't think it was you'

b. *tusa.lau.nngin.nakku* (S I: p. 78)
hear.PAST.NEG.NEG-CAUS1E/3A
'I haven't heard it'

A verb and an object are two lexical items. If the speaker intends to have the object make a specific reference, the object will be marked with a [+specific] feature when it is selected. The object and verb then merge with V projecting. The subject is selected and merged with the VP, with VP projecting. In Inuktitut the [+specific] feature is strong which requires checking at Spell-out.³² The object moves to the T projection where its strong [+specific] feature and the EPP feature of T are checked, and Nom/Abs is assigned to the object in a Spec-head relation as in (57a).³³ The conditions on movement are satisfied, i.e., the CH conditions (movement for morphological checking, object c-commands its trace, chain is uniform involving NPs) and MLC

³¹Tense is implied with the mood markers. For example de Reuse (1992: 165) writes that "agentive verbs in the indicative mood automatically have a recent past tense implication--unless a tense-marking post-base or another mood cancels that implication. Thus *neghaa*, without any postbases, is 'he ate it', rather than 'he eats it'." See also Lowe (1985: 122) for Siglit.

³²The Nom/Abs object has only a wide scope reading (Bittner 1994a) and has to move by Spell-out to take wide scope, whereas a Nom/Abs subject doesn't take just wide scope. The reason for the speaker marking an object is the topic of Chapter 2.

³³The tree structures I use are head final (SOV) and not the SVO pattern that Chomsky (1995a: Section 4.8) explains as universal. Chomsky disagrees with Kayne as to the reason for the SVO being universal. Kayne attributes it to a Linear Correspondence Axiom which falls out from X-bar phrase structure; while Chomsky, who has done away with X-bar structure as a primitive, derives the order by bare phrase structure requirements. However Chomsky (1995a: 336) says SVO is only universal "if the complement is more complex than a single terminal". Since the lexical items in Inuktitut are affixes, the SOV order is not a violation of any universality that might exist.

(the object and subject are in the same minimal domain and the subject doesn't have a feature that needs to be checked by T). The subject is in a Spec-head relation with V and is assigned Erg/Gen.

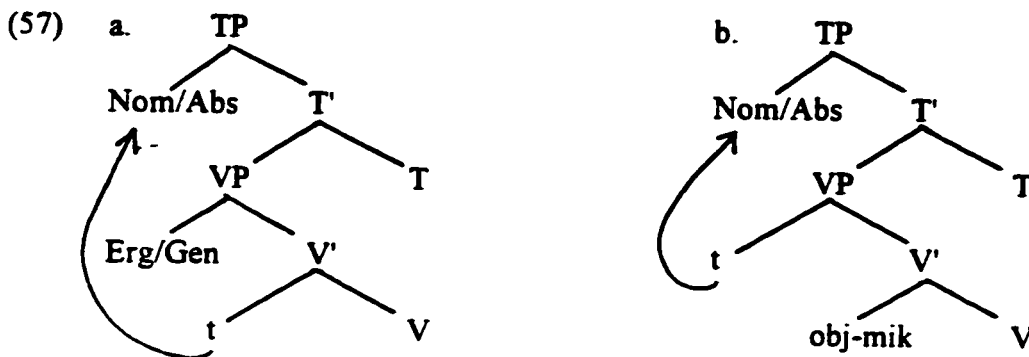

If the speaker does not intend to have the object make a specific reference, then the object is not marked with the feature [+specific] when it is selected. The object and V merge with V projecting. A subject is selected, and the subject and V projection merge. The object does not have a F that needs to be checked so stays within the VP and is assigned Acc/Inst by insertion of a "dummy" postposition *-mik* as in (58b).

(58) a. *asia sana.laur.mi.junga* (S II: p. 130)
 another-of-a-different-kind(Abs/Nom) work.PAST.also.IND3E/3A
 'He made another one of a different kind'

b. *asia.nik pi.juma.junga* (S II: p. 130)
 another-of-a-different-kind.Inst/Acc something.want.IND1A
 'I want another one of a different kind'

The subject moves to the T projection where it enters a Spec-head relation with T and is assigned Nom/Abs case, and checks the EPP feature of T. The conditions on movement (CH conditions and MLC) are satisfied. Insertion of the dummy postposition *-mik* explains its ambiguous nature. On the one hand *-mik* marks the object of a verb, and on the other hand *-mik* patterns like locative postpositions *-mi* 'in, on, at', *-mit* 'from, than (comparison)' and *-mut* 'to, agent (in

passive), with (instrument)'. In Section 1.1 *-mik* was described as being referred to as Mod or Inst or Acc. Spalding (1993 II: 179) describes Acc as not a very suitable term but better than Mod since the NP is an object. Like the locative postpositions *-mi*, *-mit* and *-mut*, *-mik* nasalizes preceding consonants and has a variant *-nik* (*-ni*, *-nit* and *-nut*) that is used if the NP is possessed or non-singular.

Miyagawa (1993) described Gen in Japanese as being checked at LF since both wide and narrow scope readings were possible. In Classical Tibetan, another ergative language, it appears that Erg subjects cannot take wide scope over negation. For example, in an Erg-Abs sentence with the negative particle *mi-* 'not', Beyer (1992: 242-243) says "it is only the occurrence of an event that can be denied, not the identity of a thing or the extent of a quality." Thus (59a) denies that the killing took place, and doesn't mean that the enemy was killed but the king didn't do it.

(59) a. rgyal-po-s dgra ma-bsad
king.Erg enemy(Abs) NEG.kill(PAST)
'the king did not kill the enemy'

b. the king didn't kill the enemy.

The English counterpart in (59a), however, has two readings. When the subject has narrow scope with respect to negation (which is LF movement of NEG), then the proposition is denied. But there is also the reading from the *in situ* positions where the subject has wide scope with respect to negation where the enemy was killed but can deny that the king did it. Thus while Nom subjects in accusative languages could have two readings, in ergative languages an Erg/Gen subject has only the one (narrow scope) reading. However, if the Erg subject has a quantifier, it can take wide or narrow scope (see Chapter 2).

So far I have discussed the case marking on arguments of verbs. Now I look at the case

marking on adnominals. Gen case is assigned to arguments of a N as in (60) and to *in situ* subjects of a V in Japanese as in (61) and gerunds in English as in (62).

(60) a. [_{DP} Mary-no nihon-de-no suugaku-no benkyoo] (Mi: eg. 6)
 [_{DP} Mary-Gen Japan-in-Gen math-Gen studying]
 'Mary's studying of math in Japan'

b. *Tommy's nail's sack

c. Tommy's sack of nails

(61) a. [_{DP} [_{IP} kinoo Hanako-no katta] hon] (Mi: eg. 7)
 [_{DP} [_{IP} yesterday Hanako-Gen bought] book]
 'The book that Hanako bought yesterday'

b. [_{DP} [_{IP} Taroo-no nama-de tabeta] sakana]-wa maguro da (Mi: eg. 78)
 [_{DP} [_{IP} Taroo-Gen raw ate] fish]-Top tuna is
 'The fish that Taro ate raw is tuna'

(62) a. [John's reading the book] disturbed me (C 1986a: eg. 275ii)

b. John's having been appointed (C 1986a: p. 195)

In Japanese it is possible to have subject and object adnominals with Gen case as in (60a), whereas in English only one 's Gen case marker is allowed and *of*-insertion is used for the other argument as in (60c). To check Gen (at LF) in Japanese, Miyagawa (1993: 219) "presume[s] that one genitive phrase moves into the Spec, and the other adjoins to the DP, in essence counting as a second Spec position."

Inuktitut, like Japanese, allows both subject and object adnominals to appear with Gen/Erg case as in (63).

(63) taami.up kikia.ngita puu.ngat
 Tommy.Gen/Erg nail.(pl)3sgPOSSGen/Erg sack.3plPOSS(Abs/Nom)
 'Tommy's sack of nails'

The Gen/Erg case of the subject adnominal is assigned *in situ* in a Spec-head relation. The

strategy of multiple projections for checking allows the object adnominal with Gen/Erg case to adjoin to the NP and also be assigned Gen/Erg case in a Spec-head relation. This strategy is used in Japanese and Inuktitut but is not allowed in English, hence the *of*-insertion in English to provide a head P for checking the case of the adnominal argument.

1.6 Summary

This chapter began with a description of some of the unexplained characteristics of ergative languages: binding follows an accusative pattern whereas grammatical relations follow an ergative pattern, split ergativity exists with both an S/O and an S/A patterning, a variety of case terms are used in referring to arguments, and the similarity between the agreement on verbs and on possessums. The first is not dealt with in this study. The last has not yet been dealt with since this chapter looks at case assignment and not agreement. (Chapter 5 looks at agreement.)

"Split ergativity" was explained by specific objects moving to [Spec, T] at Spell-out while non-specific objects remain inside the VP. I showed that in Inuktitut, and implied for languages in general, that when the speaker intends to pick out a particular object it is marked with a [+specific] feature which requires the object to move outside the VP and take wide scope. The specific object cannot be checked by V as it would still be within the scope of V. Thus the mood head T is targetted and movement of the specific object results in Abs/Nom case marking on the object while the subject NP remains inside the VP and has Erg/Gen case marking. It was also suggested by the scope readings of Erg/Gen subjects with negation in Classical Tibetan that the Gen/Erg subject remains inside the VP. If the speaker does not pick out a particular object, the subject moves to T and is assigned Abs/Nom case and the object remains inside the scope of the VP and is assigned Inst/Acc case with the postposition *-mik*. With unaccusative and

unergative verbs, the sole NP argument moves to T and gets Abs/Nom case.

The variety of terms used to describe the case of arguments is possible because the correspondence between grammatical and semantic relations of the arguments in ergative languages is not the same as in accusative languages, and the choice of case term depends on which similarity or difference is being focussed on. This chapter looked at how case was handled from *Knowledge of Language* (1986a) to the *Minimalist Program* (1995a). It pointed out the differences between structural cases and inherent/semantic cases in ergative languages. The explanation for case assignment in Inuktitut was presented within the Minimalist Program, and as such it was able to demonstrate why a feature is strong, and, importantly, it was able to remove the stipulation from the Minimalist Program that arguments must move to have their case checked while other features could be checked *in situ*.

In this chapter I have described how specific objects take wide scope at Spell-out in ergative languages with the resultant Erg/Gen-Abs/Nom case marking for specific objects and Abs/Nom-Inst/Acc case marking for non-specific objects. This study shows that the difference between ergative and accusative languages is that specific objects are checked at Spell-out in the former but not until LF in the latter. The outline for the remaining chapters in this study is as follows.

Chapter 2 explains why an object is specific, what is meant by specific, and provides evidence that speaker intentions to pick out a particular object do indeed account for the Erg/Gen-Abs/Nom case marking pattern versus the Abs/Nom-Inst/Acc case marking pattern, and for the difference between ergative and accusative languages.

Chapter 3 describes various parameters that have been formulated to account for the ergative case

marking in Inuktitut. The analysis in Chapters 1 and 2 accounted for the existence of ergative and of accusative languages, and I show that the five parametric explanations do not provide as adequate an empirical and theoretical explanation.

Chapter 4 is a description of the case marking in nominals. It supports the analysis of case assignment established by Chapters 1, 2 and 3.

Chapter 5 switches to agreement. Although both case and agreement are in Spec-head relations, they are independent. Chapter 5 shows that while specificity affects the conceptual-intentional interface, agreement (and the similarity between agreement on verbs and possessums) is relevant to the articulatory-perceptual level.

Chapter 6 is a conclusion that summarizes the main proposals and findings of this study.

Chapter 2

Case Marking and Speaker Intentions

2.1 Introduction

In Chapter 1 it was stated that transitive sentences in Inuktitut, and ergative languages in general, can have Erg/Gen-Abs/Nom case marking and agreement as shown in the (a) examples or Abs/Nom-Inst/Acc case marking and agreement as shown in the (b) examples.

Inuktitut, an Eskimo-Aleut language:

- (1) a. anguti.up tuktu taku.janga
man.Erg/Gen caribou(Abs/Nom) see.IND3E/3A
'the/a man sees the caribou'
- b. anguti tuktu.mik taku.juq
man(Abs/Nom) caribou.Inst/Acc see.IND3A
'the man sees a caribou'

Mam, a Mayan language (Campana 1992: 141):

- (2) a. ma chi tzaj t-q'o-7n Mal kab' xkoo7ya w-ee-ky'
rec 3pA dir 3sE-give-ds Maria two tomato is-RN-1s
'Maria gave me some tomatoes'
- b. Mal β - β -saj q'oo-n t-e xkoo7ya w-ee-ky'
Maria asp-3sA-dir give-AP 3s-RN tomato is-RN-1s
'Maria gave me some tomatoes'

Dyirbal (Bok-Bennema 1991: 26 [from Dixon])

- (3) a. Palan jukumpil pangkul yarangku palka-n
the woman-Abs the man-Erg hit-NONFUT
'The man hit the woman'
- b. payi yara (pangkun jukumpiru) palga-nga-nyu
the man-Abs (the woman-Obl) hit-NGAY-NONFUT
'The man hit (the woman)'

It was also stated that in Inuktitut, Erg/Gen-Abs/Nom case marking, as shown in (1a), results

from movement of specific objects outside the VP taking place at Spell-out' (S-structure) in ergative languages, and that what is meant by specificity is speaker's intentions to pick out a particular object. The object must move outside the VP to take wide scope, so it moves to [Spec, T]. The NP object takes wide scope, and is assigned Abs/Nom case by T. The NP subject is assigned Erg/Gen case *in situ* in a Spec-head relation with the V head. Thus, specificity of an object can explain the Erg/Gen-Abs/Nom case marking.

But ergative languages also have sentences with Abs/Nom-Inst/Acc case marking as shown in the (b) examples. We would expect that these sentences would be used when an object is non-specific, i.e., when the speaker does not intend to pick out a particular object. This is precisely what does happen. Corston² describes Roviana, an ergative West Oceanic language spoken in the Solomon Islands, as using the backgrounded object construction (our non-specific sentences) obligatorily if the undergoer is non-specific. By non-specific he means "that the speaker doesn't have a particular ref[erent] in mind, even if one might be said to exist." Another example is Dixon's (1994: 195) description of sentences with Abs/Nom-Inst/Acc case marking as being used "when the speaker *does not want to specify the underlying O NP* [italics mine]. ...

¹Campana (1992) provides a different analysis where, following Chomsky (1992[1991]), the NPs are inserted fully case inflected. The NPs are in their base generated positions at Spell-out with movement for case checking at LF. Thus the NP subject is inserted with Erg case and is in [Spec, V], while the NP object is inserted with Abs case and is in the complement of the V position at Spell-out. (However see note 18.) He considers sentences with subjects and objects that show only subject agreement as intransitive antipassive constructions in which a rule of antipassive formation has applied to the basic Erg-Abs sentence.

²The description of Roviana was in an email message "Sum: Nonreferential NP's in English" on *Linguist List* Vol-6-948 (Friday July 1995) from Simon Corston.

to mark reflexive ... [and] to satisfy the S/O pivot [i.e., subject of sentence] condition". These sentences are variously described as antipassive constructions, derived forms, transitive verbs with an antipassive morpheme, backgrounded object constructions, and intransitive constructions (cf. Dixon 1994, Campana 1992, Johns 1987). The "antipassive" construction will not be separately addressed,³ but Chapter 6 relates this specific/non-specific distinction to other ergative languages.

A non-specific object remains inside the VP and the subject moves to [Spec, T] where it gets Abs/Nom case. In Inuktitut a postposition case marker is inserted to assign Inst/Acc case to the theta-role object. That is, the specific/non-specific contrast dictates whether an object moves to [Spec, T] or remains *in situ*. The position of the NP object determines whether it gets Abs/Nom or Inst/Acc case marking.

In Section 2.2 I show that specificity marks speaker intentions, and in Section 2.3 that specificity is semantic. In Section 2.4 I show that the analysis of specificity by Donnellan (1966, 1978) is the correct account for English, and that specific objects move covertly to take wide scope. Section 2.3 compares specificity in ergative languages with movement at Spell-out to specificity in accusative languages with movement after Spell-out.

2.2 Specificity Marks Speaker Intentions

Inuktitut has both Erg/Gen-Abs/Nom and Abs/Nom-Inst/Acc case marking as illustrated in (4), and (1) above. When the Erg/Gen-Abs/Nom case marking is used there is agreement on the verb

³For a description of theoretical approaches towards antipassives, see Bok-Bennema (1991: Chapter VI).

that indicates person and number of the subject and object⁴ as in (4a). When there is Abs/Nom-Inst/Acc case marking, there is an agreement morpheme on the verb that indicates person and number only of the subject as in (4b).

(4) a. *nattirsuittuarju.kulu.up kati.ga.mi.uk nanualuk tuumgaaluk aglu.mi* (S II: p. 143)
Nattiqsuittuarjuk.poor-little.Erg/Gen meet.CAUS.3ssE.3A big-bear(Abs/Nom)
scary-spirit(Abs/Nom) breathing-hole.Loc
'when poor little Nattiqsuittuarjuk met the big scary bear helping spirit at the breathing hole'

b. *atausi.tuinnar.mik taku.juq* (S I: p. 12)
one.just.Inst/Acc see.IND3A
'He saw just one'

Five types of evidence are provided to show that Erg/Gen-Abs/Nom case marking and a subject/object agreement ending on the verb indicates speaker intentions to pick out a particular object (see also Manga 1994a, 1994b, 1996). First, I show that all types of NP objects can be used in sentences with Erg/Gen-Abs/Nom case marking and with Abs/Nom-Inst/Acc case marking. Second, sentences with overt object NPs are compared to minimal sentences which contain only a verb and mood and agreement markers (NPs are *pro*). The comparison shows that a specific object is picked out by subject/object agreement marked on the verb and not by an overt NP. This is supported by an examination of coreference in coordinated sentences in the following sub-section, adult native speakers' interpretations in sub-section four, and examples of sentences in stories and spontaneous speech in sub-section five.

⁴The terms subject and object refer to thematic argument NPs of the verb.

2.2.1 Lexical Items

Inuktitut, which does not have articles, can have object NPs which are proper names, demonstrative pronouns, relative clauses, quantifiers or pronominals with Abs/Nom case as in the

(a) examples or with Inst/Acc case as in the (b) examples.

Object is a Proper Noun

(5) a. Jaani ikaju.qqau.jara
Johnny(Abs/Nom) help.PAST.IND1E/3A
'I helped Johnny'

b. Jaani.mik ikaju.qqau.junga
Johnny.Inst/Acc help.PAST.IND1A
'I helped Johnny'

Object has a Relative Clause

(6) a. qimmiq mali.qqau.jara [ikpaqsaq taku.lauq.tavut]
dog(Abs/Nom) follow.PAST.IND1E/3A [yesterday see.PAST.IND1p1E/3A]
'I followed the dog we saw yesterday'

b. qimmir.mik mali.qqau.junga [ikpaqsaq taku.lauq.ta.ttin.nik]
dog.Inst/Acc follow.PAST.IND1A [yesterday see.PAST.doe.1p1POSS.Inst/Acc]
'I followed a dog we saw yesterday'

Object is a Demonstrative Pronoun

(7) a. taingna qunga.qqau.janga
that-person-there(Abs/Nom) smile.PAST.IND3E/3A
'he smiled at her/that person there'

b. taiksumunga qunga.qqau.juq
that-person-there(All) smile. PAST.IND3A
'he smiled at her/that person there'

Object is a Quantifier

(8) a. tamarmik nipi.it naala.lauq.takka
all(Abs/Nom) tape.pl(Abs/Nom) listen.PAST.IND1E/3plA
'I listened to all the tapes'

b. tamain.nik nipi.nik naala.lauq.tunga
all.(pl)Inst/Acc tape.(pl)Inst/Acc listen.PAST.IND1A
'I listened to all the tapes'

(9) a. ila.ngit nipi.it naala.lauq.takka
some.pl(Abs/Nom) tape.pl(Abs/Nom) listen.PAST.IND1E/3plA
'I listened to some tapes'

b. ila.ngin.nik nipi.nik naala.lauq.tunga
all.pl.Inst/Acc tape.(pl)Inst/Acc listen.PAST.IND1A
'I listened to some tapes'

Object is a Pronoun

(10) a. una ikaju.qqau.jara
him/her(Abs/Nom) help.PAST.IND1E/3A
'I helped him/her'

b. uuminga ikaju.qqau.junga
him/her(Inst/Acc) help.PAST.IND1A
'I helped him/her'

Thus any difference between the two case marking patterns with respect to specificity is not due to any type of inherent specificity/definiteness of the lexical item that is the object.

The difference between the (a) and (b) forms is also not explained by a definite/indefinite distinction (see Bittner (1987)). Specific reference can be made with indefinite NPs as in (9a) and in the West Greenlandic example in (11).

(11) kina.luunniit uqaluqatigi.sinnaa.vat (B 1987: p. 197)
who.ever(Abs/Nom) talk-with.can.IND2E/3A
'You can talk with somebody/anybody'

And non-specific reference can be made with proper names (5b), pronouns (10b), definite descriptions (6b), demonstratives (7b), and quantifiers (8b). Specific objects in Inuktitut are translated into English by *the* while non-specific objects by *a* since in the unmarked case definite objects in English are specific while indefinite objects are non-specific (see Section 2.4).

2.2.2 Minimal Sentence

Both (12a) and (12b) have the same gloss in English.⁵ However, a comparison of the examples in (12) with the minimal sentences in (13) shows that it is the agreement morpheme on the verb that picks out a particular entity and not the overt NP.

(12) a. qimmi.up (uvanga) kii.qqau.ja.a.nga
dog.Erg/Gen (1-Abs/Nom) bite.PAST.IND.3E.1A
'the/a dog bit me'

b. qimmiq uvan.nik kii.si.qqau.juq
dog.Abs 1.Inst/Acc bite.AP.PAST.IND3A
'the/a dog bit me'

(13) a. kii.ja.a.nga
bite.IND.3E.1A
'it is biting me'

b. kii.si.juq
bite.AP.IND3A
'it is biting someone/something'

In (13a) a specific individual is picked out; whereas in (13b) no particular individual is picked out by the speaker and there is a non-specific interpretation.⁶ For convenience, since I show that speaker's intentions to pick out a particular object account for the two case marking and agreement patterns, I will henceforth often refer to the (a) type sentences as 'specific' and the (b) type sentences as 'non-specific'.

⁵In example (12a) *uvanga* would not normally be used since *me* is already known from the *-nga* in the agreement marker *-ja.a.nga*. To put it in would be like saying *me* twice. It is shown for comparison of case marking with *uvannik* in (12b).

⁶Note that the object agreement marker that is on the verb for Erg/Gen-Abs/Nom sentences is not itself the object. The object is an overt NP or *pro*. Object agreement indicates a specific object.

2.2.3 Coordinated Sentences

In coordinated sentences if the verb in the second sentence has a subject/object agreement ending as in the (a) and (b) examples in (14) and (15), then the object in the second sentence must pick out something in the first sentence.⁷ It does not matter whether the first sentence is specific as in the (a) examples, or whether the first sentence is non-specific as in the (b) examples. However, if the verb in the second of two coordinated sentences has only a subject agreement ending as in the (c) and (d) examples, then the object in the second sentence does not refer to anything in the first sentence. It does not matter whether the first sentence is specific as in the (c) examples or non-specific as in the (d) examples.

- (14) a. Jaani ikaju.qqau.jaa, ikaju.qqau.jait.tauq (2E/3A)
b. Jaani.mik ikaju.qqau.juq, ikaju.qqau.jait.tauq (3E/3A)
'he, helped Johnny, and also you helped him_{vj'rk}'
c. Jaani ikaju.qqau.jaa, ikaju.qqau.jutit.tauq (2A)
d. Jaani.mik ikaju.qqau.juq, ikaju.qqau.jutit.tauq (2A)
'he helped Johnny and also you helped'
- (15) a. tamarmik taku.lauq.tatit, taku.lauq.takka.ttauq (1E/3plA)
b. tamain.nik taku.lauq.tutit, taku.lauq.takka.ttauq (1E/3plA)
'you saw all, (of them) and also I saw them_{v'j}'
c. tamarmik taku.lauq.tatit, taku.lauq.tunga.ttauq (1A)
d. tamain.nik taku.lauq.tutit, taku.lauq.tunga.ttauq (1A)
'you saw all (of them) and also I saw (one/some/all)'

These examples in (14) and (15) indicate that an object in a specific sentence must pick out a

⁷Bittner (1995: 73-74) presents four discourse scenarios in which the first sentence contains an incorporated mass noun and the following sentence has two clauses which are linked to the first with four combinations of Erg/Gen-Abs/Nom and Abs/Nom-Inst/Acc clauses. The readings with Abs/Nom objects would support this analysis where it makes specific reference.

particular entity, while an object in a non-specific sentence does not pick out a particular entity.

2.2.4 Native Speaker's Interpretations

I conducted a game with adult native speakers in which identical items were placed into two groups in front of the native speaker. In one group was one item and in the other group were four items. The native speaker was then requested to do something using either a specific request as illustrated in (16a) or a non-specific request as in (16b).

(16) a. **figu.guk**
take.OPT2E/3A
'(you) take it'

b. **figu.si.git**
take.AP.OPT2A
'(you) take something'

With a specific request as in (16a), native speakers took the one item in the group of one, and in one case a native speaker asked *which one, which one?* With a non-specific request as in (16b), native speakers took one or more items from the group of four, and in one case a native speaker mumbled *any which one* as he took one item from the group of four items. This behaviour indicates that native speakers interpreted the use of a specific sentence as the speaker's intention to pick out a particular object, and the use of a non-specific sentence as not picking out a particular entity (see Section 2.3).

2.2.5 Stories and Spontaneous Speech

So far we have seen that sentences with Erg/Gen-Abs/Nom case marking and subject/object agreement on the verb (i) can be used with any NP object, (ii) pick out a particular object in minimal sentences, (iii) pick out an entity from the first sentence when the second of two

coordinated sentences is specific, and (iv) are interpreted by the native speaker as the speaker picking out a particular object. In this section we see that if the speaker intends to pick out an entity, even if that entity is just introduced for the first time, there is Erg/Gen-Abs/Nom case marking and subject/object agreement on the verb. Menecier (1992-93: 36) provides an example in the *tunumiisut* dialect of East Greenland where the object is a new object, being introduced for the first time, yet the object is indicated with a subject/object agreement marker on the verb and Erg-Abs case marking. This is shown in (17).

- (17) soomattinni qernimisaarmgaartivangaasiit qatsimaleq tagivarnga, qatsimalit martit
 suuqna-ttinni qiqnimi.saaQ+Naaq-tiv-a-ngaasiit
 devant-1+All regarder à la jumelle-Eff-Conc-1-comme toujours
 qas.sima.ti-q taki-va-Na[0] qas.sima.ti-t maqti.t
 phoque sur la glace-[Abs] voir-IND-1[+3] phoque sur la glace-Pl(Abs) 2(Abs)
 'en scrutant devant nous à la jumelle, je vois un phoque couché sur la glace, deux
 phoques'

Another example is (18), taken from Bittner (1987: 197-198). It is an excerpt from the West Greenlandic Eskimo (WGE) translation of the Gospel according to Matthew. Bittner describes WGE as often using the Abs form of the object where English would use an indefinite object. Thus for the example (18), she gives the English translation as *Next morning on his way to the city he felt hungry; and seeing a fig-tree at the roadside he went up to it, etc.* There is subject/object agreement marker on the verb, and the object agreement picks out a particular object, *fiqiqussuaq* 'fig tree', which has not been previously introduced.

- (18) [fiqiqussuaq=lu aqqusimup saniani=it-tuq] taku-ga-miuk
 [fig-tree(Abs)=and of.road at.its.side=be-int.prt(Abs)] see-CAUS-3ssE/3A
 ...and as he saw [fig-tree(Abs) standing at the side of the road]

2.3 Specificity is Semantic

The last section has shown that a sentence with Erg/Gen-Abs/Nom case marking is used when the speaker intends to pick out a particular entity. In Section 2.2.1 I showed that specificity is not an inherent property of individual lexical items. In Sections 2.2.2 and 2.2.3 I showed that Erg/Gen-Abs/Nom sentences pick out a particular object. And in Sections 2.2.4 and 2.2.5 I showed that Erg/Gen-Abs/Nom sentences are used for and interpreted as picking out a particular object.

This section shows that this specificity is semantic and marks speaker intentions and not beliefs nor existence of the object. With a specific referent a speaker picks out an entity and says something about it, even if the description does not exactly fit, it still picks out the entity. With a non-specific referent the speaker is attributing some property. If specificity is semantic rather than pragmatic, there should be differences in the type of questions that can be asked and in the truth conditions of the sentence (Donnellan 1978, 1966). With a specific reference, if one is not sure what entity the speaker is intending to pick out one can question *the N*. There was an example of this in Section 2.2.4 where the native speaker asked *which one, which one?* in response to a specific request to *take it* (see (16a)). With a non-specific reference the speaker could not question *the N* as there is no particular N that is being picked out (Donnellan 1966, 1978; Manga 1994a). Another example is illustrated in (19). To question whose tape was touched, the non-specific form of the question must be used as in (19b).

- (19) a. *kia nipi.quti.nga aktu.lauq.pauk?
who(Erg/Gen) tape.own.3Poss(Abs/Nom) touch.PAST.Q3E/3A

- b. *kia nipi.quti.nga.nik aktuq.si.lauq.pa?*
who(Erg/Gen) tape.own.3Poss.Inst/Acc touch.AP.PAST.Q3A
'whose tape did he touch?'
(19a okay as *who touched his tape?*)

The specific form in (19a) is ungrammatical because it is semantically incompatible to assert the specificity of the object while questioning its specificity at the same time.⁸

The truth conditions of sentences with specific versus non-specific reference are also different. With specific reference the sentence can be true or false. For example in (12a) if the dog really did bite me the sentence is true but if the dog didn't bite me then the sentence is false. However, with non-specific reference the truth conditions of the sentence are different. In example (12b) if the dog did bite me then the sentence is true, but if the dog didn't bite me then the sentence is neither true nor false as it still did bite someone/something. The types of questions and the truth conditions show that specificity is semantic.

Specificity is the speaker's intentions to pick out the object, and not the existence of the object nor the speaker's beliefs (cf. Donnellan 1966: 287-8, 1978: 50; Manga 1994a: 7-10), since any lexical NP including names and demonstrative pronouns can be specific or non-specific. Speaker's intentions to pick out the object can explain the specific reference in (20) and (21), whereas neither speaker's beliefs nor existence of object can. Example (21) is from the conversation of two children at a birthday party.⁹

⁸ This is based on Bellert's (1977) observation that you don't have sentential adverbs in questions since you would be making an assertion while trying to question it at the same time. Native speakers find (19a) with the meaning *whose tape did he touch?* as funny.

⁹The conversation was told to me by one of my native informants in Igloolik.

(20) *katak. niq.paa* (S II: p. 143)
drop.unknowingly.IND3E/3A
'he unknowingly dropped it (without being aware)'

(21) A: *inuaguligarjung.mik taku.lauq.puq*
gnome.Inst/Acc see.PAST.IND3A
'she saw a gnome'

B: *uvanga.ttauq taku.lauq.tara*
1Erg/Gen.also see.PAST.IND1E/3A
'I also saw it'

And, as already discussed in 2.2.1 and 2.2.5, the use of the Abs/Nom-Inst/Acc as in (21A) cannot be attributed to introducing an entity into discourse.

Specificity is also not pragmatic. For West Greenlandic, Fortescue (1984: 174) describes pragmatic/contextual factors as affecting the relatively free word-order of the language, not the case marking. A sentence with Erg/Gen-Abs/Nom case marking can have the neutral word order of SOV. If the word order is OSV, then O is the theme, what the sentence is about. If the order is SVO, then the O is emphasized or focused. And if the order is OVS, then the S is new information or is the answer to a question.

2.4 Specificity in English

We have claimed that specificity in Inuktitut accounts for Erg/Gen-Abs/Nom case marking because in ergative languages the movement of specific objects to take wide scope occurs at Spell-out, while in accusative languages movement of specific objects occurs covertly. The meaning given to specificity is based on Donnellan's (1966, 1978) analysis of definite NPs in English. He distinguishes a referential (specific) from an attributive (non-specific) reading for

definite NPs and describes the referential use as "a device for getting one's audience to pick out or think of the thing to be spoken about" (1966: 304).

Both definite and indefinite NPs in English can have two interpretations--a referential one which picks out a specific thing/person and an attributive one which focuses on the attributes of a thing/person (cf. Donnellan (1966, 1978) and Partee (1972) for definite NPs, Partee (1972) and Ioup (1977) for indefinite NPs). Both possible interpretations are semantic properties determined by speaker reference, or lack of it, and in this study are referred to by the terms specific (i.e., referential) and non-specific (i.e., attributive) respectively.

(22) Interpretation of NPs (in accusative languages)

	<u>specific</u>	<u>non-specific</u>
definite NP:	unmarked	in opaque context
indefinite NP:	in opaque context	unmarked

As shown in (22), the unmarked interpretation of a definite NP is specific, but there is also a marked non-specific reading which is available when an operator is present which takes scope over the definite NP. An indefinite NP will have as unmarked the non-specific reading, and in opaque contexts the specific reading is also available.¹⁰

Section 2.4.1 will show that Donnellan's approach can account for the referential and

¹⁰Indefinite NPs are not discussed in this study. For an analysis of indefinite NPs having two interpretations, see, for example, Fillmore (1967), Partee (1972) and Ioup (1977). The terms used to distinguish the readings vary. Fillmore uses [\pm specific], Partee referential and non-referential, and Ioup specific and non-specific. Manga (1994a) shows that the two readings arise in opaque contexts, and that the specific reading is based on the speaker's intention to make a particular reference.

attributive readings of definite NPs. Section 2.4.2 extends the analysis to definite pronominal NPs. Section 2.4.3 considers Heim's (1991) critique of the Donnellan approach. Section 2.4.4 is a short summary.

2.4.1 Specificity and Definite NPs

Donnellan (1966, 1978) distinguishes between a referential use and an attributive use of the definite NP in English.¹¹ Used attributively, the definite NP states something about the NP, which is similar to the denotation of the NP. But when used referentially, the definite NP calls attention to a person/thing and is used by the speaker to let the hearer know what is being spoken about. An illustration is in (23) where the definite NP *the book* can have a referential interpretation or an attributive interpretation.

(23) Bring me the book on the table (D 1966)

The two readings are distinguished in the following ways. First, when used referentially, it picks out something (a book) the speaker is referring to and orders the person to bring it to him. Even if the description does not exactly fit the thing (the book), it can still pick it out. For example, if the book were not on the table but beside the table, the definite description could still indicate the book you were referring to and have someone bring it. The hearer could ask questions about the speaker reference such as *Is this the book you meant?* or *Do you mean the book by Robertson Davies?* These questions indicate that the hearer interprets the speaker as picking out something in particular.

¹¹Partee (1972) agrees with Donnellan (1966) that definite NPs can have referential or attributive readings though she uses the terms referential and non-referential to distinguish the two interpretations.

But if the definite NP *the book* is used attributively, no particular item is being referred to; rather, it is the attribute that is important. Suppose that you didn't want anything put on your prize antique table and you are told someone put a book on the table. Then if you uttered *Bring me the book on the table*, the definite NP *the book* is being used attributively about something being on the table. If there were no book on the table, the command could not be obeyed. A question could neither be asked nor answered that made reference to the book since there is no particular book in mind. Suppose the book were on the floor but a pen was on the table. You wouldn't ask *You mean the book on the floor?* or *You mean the book by Pierre Berton?* rather, you might bring the pen and ask *You mean the pen on the table?*

There are three differences between the referential and attributive uses that Donnellan notes. The first two differences have already been illustrated in (23). First, the referential use is to pick out something/someone the speaker has in mind¹² and say something about it/him; it presupposes/implies that something/someone fits the description. The attributive use says something about something/someone, but does not presuppose it of anyone/anything in particular. Second there is a difference in the type of questions that can be asked. With the referential use, questions can be asked that refer to what the speaker was picking out; whereas they cannot with the attributive use. The third difference relates to the truth conditions of assertions. In the command in (23) if there is a book on the table, then for both the referential and attributive uses

¹²See Donnellan (1966: 287-8; 1978: 50) for a discussion as to why it is the intention of the speaker to pick out something/someone rather than the belief that something/someone fits the description that forms the basis for speaker reference. For an example of why use of the definite NP is not to say that something uniquely has the properties, see Donnellan (1978: 56-60).

the command can be obeyed. But if the presupposition is false, i.e., the book is not on the table but, say, on the floor, then for the referential use the command can still be obeyed. However for the attributive use, the command could not be obeyed as no particular book is being picked out and there is no book on the table. A similar difference is noted for the truth values in assertions if the presupposition is false.

(24) Smith's murderer is insane (D 1966)

In (24) for the referential use the speaker is picking out someone, say Jones, while for the attributive use whoever murdered Smith has the quality of insanity. If the presupposition is true, i.e., Smith was murdered, then the sentence is true for both referential and attributive uses. However, if the presupposition is false, i.e., Smith was not murdered, then the truth values for the referential and attributive uses differ. For the referential use, the person Jones could still be picked out if he is insane though he didn't murder Smith, and in this sense the sentence is true. However for the attributive use, the sentence is neither true nor false as it does not apply if there was no murderer.

Donnellan¹³ did not consider the referential and attributive interpretations for definite NPs as related to opaque contexts. However all the examples he used to show ambiguity with definite NPs (i.e., existence of both readings) involved sentences with operators such as the copula, question, and optative or future tense as in (25).

(25) a. Bring me the book on the table (D 1966)

¹³Also Partee (1972) did not consider the referential and attributive readings as related to opaque contexts. All her examples of ambiguity involved sentences with operators.

- b. Smith's murderer is insane (D 1966)
- c. Who is the man drinking a martini? (D 1966)
- d. The Republican candidate for president in 1964 will be a conservative (D 1966)

These types of sentences can be considered as creating opaque domains.¹⁴ The attributive reading in (25a) is possible because the optative mood expresses a desire/wish which is similar to propositional attitude predicates believes/hopes that do create opaque contexts. Similarly an attributive reading in (25b) is possible with a copula because the copula functions to equate the object attribute to the subject. When the operator takes wide scope the definite NP would take narrow scope and the attributive reading would be more salient.

When there is no operator, as in (26), I suggest that the referential reading where the definite NP takes wide scope is the preferred interpretation.

- (26) a. He put the book on the table
- b. I met the man who drank a martini

At first glance taking wide scope would seem to go against the description of definite NPs as not being quantificational. According to Abbott (1993: 49) "There is little independent justification for a quantificational analysis of pronouns and proper names, which nevertheless (like anaphoric definites) behave like explicitly quantified NPs in existential sentences". She claims crossover violations are created by quantificational NPs even though they only move at LF as shown in (27a), but a definite NP does not seem to create crossover violations as shown in (27b).

¹⁴For example, Ioup (1977) cites imperatives as creating an opaque environment for the indefinite *kogo*- 'someone' in Russian.

(27) a. *His, mother loves [every boy];

b. His, mother loves John,

However the rejection of a quantificational reading with definite NPs is not so clear cut as (27b) implies. When I asked native speakers of English, for sentences similar to (27b), whether the object could be coreferential with *his*, the preferred interpretation was that they do not corefer.¹⁵

In fact 72% of the judgements of the sentences did not allow coreference.

(28) a. His mother is meeting/met [the doctor] at the restaurant

b. His professor is coaching/coached [the football player] on Saturday

c. His mother is meeting/met [John] at the restaurant

Coreference would only be possible if the definite NP were attributive, since it would remain inside the VP and neither the pronominal *his* nor the object are bound and thus could corefer. However the unmarked reading of definite NPs is referential. The definite NP raises covertly to take wide scope. In this position the object c-commands and locally binds *his*, thereby

¹⁵The examples in (28) were judgements obtained from 13 native speakers of Canadian English. For 4 native speakers it was not possible for *his* and the definite NP object to be coreferential for any of the 3 sentences, regardless of the tense. Four of the speakers would allow coreferentially only in (28c), regardless of the tense, but not in (a) or (b). Two of the speakers would allow coreferentially in both (28c) and either (a) or (b). Three speakers would allow coreferentially in only one example, either (28a) or (28b). The results for sentence type are as follows where the first digit indicates how many would allow coreferentially and the second digit how many native speakers would not allow the possibility of coreferentially.

	(28a)	(28b)	(28c)
Present	3 - 5	0 - 8	4 - 4
Past	1 - 4	1 - 4	2 - 3
Total	4 - 9	1 - 12	6 - 7

Of the 39 (3x13) possible judgements, 28 (i.e., 72%) did not allow coreference between the object and *his*.

prohibiting coreferentiality or a Binding Condition B violation would ensue. Hence a definite NP can create crossover effects, which supports definite NPs being used specifically as taking wide scope.

2.4.2 Specificity and Pronominal NPs

Pronominal NPs provide further evidence that speaker intentions to pick out an entity are an essential part of definite NPs. Donnellan (1978) describes pronominal NPs as anaphoric definite NPs with their semantic reference determined by the antecedent NP which can be referential or attributive. In (29) *the fat old humbug we met yesterday* is used referentially by speaker A. This is confirmed by the types of questions that can be asked, i.e., the questions can make reference to the particular person the speaker has in mind as in *Whom do you mean?* or *Which fat old humbug?* *He* refers to the person the speaker picked out.

(29) A: The fat old humbug we met yesterday has just been made a full professor. (D 1978)
He must have bamboozled the committee.

B: I don't think **he's** fat; **he's** just large boned. (D 1978)

The listener B can also respond using pronouns that refer to the person the speaker picked out as in (29B). Donnellan uses (29B) to show that the pronoun takes on the semantic reference of its antecedent, and *he* refers to the person the speaker picked out.

The antecedent in (29) is a referential definite. The antecedent of a pronominal could also be a referential indefinite as in (30). If the speaker expected the audience to know to whom the speaker was referring he could use the definite NP in (29). If the speaker assumes the audience wouldn't know to whom the speaker was referring, an indefinite NP would be used as in (30).

(30) A man came to the office today. He tried to sell me an encyclopedia. (D 1978)

Both the indefinite NP and the pronoun are referential, i.e., the speaker is picking out what he wants to talk about (see Donnellan 1978: 61-65).

In (31) the definite NP *the strongest man in the world* is used attributively, and *he* refers to its attributive meaning. Thus questions that refer to a particular person would be meaningless. It would be odd to ask *Whom do you mean?* or *Are you referring to Vladimir Jones?*

(31) A: The strongest man in the world can lift at least 450 pounds. (D 1978)
He can also win a tug of war with a jackass

B: !He is my neighbour

C: He really must be strong

The listener's response would not make reference to a particular person as in (31B), though it could refer to its attributive use as in (31C).

Section 2.4.1 showed that definite NPs could have a referential or an attributive reading and that the referential was the unmarked reading. The description of definite pronominals in this section shows that definite pronouns are referential and make reference to a particular antecedent. Donnellan (1978: 61) argues that the speaker reference of the definite pronominal allows the semantic reference (referential or attributive) of the antecedent, and, by implication, speaker reference is an essential part of the interpretation of definite NPs.

2.4.3 Heim's Critique of Donnellan

Heim (1991) agrees with Donnellan that there are two readings for definite NPs, a referential one and an attributive one, and that the attributive interpretation corresponds to the "classical" meaning attributed to definite NPs in earlier approaches by, for example, Russell or Frege.

However, she disagrees with his analysis that they are separate readings. Rather, she says there is only the classical reading and that the referential reading arises due to context/utterance situation (pragmatics).¹⁶ She provides three types of evidence against an analysis of separate readings.

One type of evidence refers to the types of propositions that *it/this/that* can refer to. It seems like the definite NP *the horse* in (32) has two readings.

(32) The horse which I bet on won. Hans had foreseen it. (H 1991: 16)

In (32), *it* can refer to the proposition where *the horse* is referential, i.e., Hans foresaw that Fortuna (the horse I bet on) would win. But *it* can also refer to the proposition where *the horse* is attributive, i.e., Hans foresaw that whichever horse I bet on would win. This would suggest that there are indeed two readings for the definite NP *the horse*--a referential one and an attributive one. Heim argues that this does not necessarily show there are two separate readings. The "proposition-anaphor *it*" can pick out propositions which might only be suggested in the preceding text, which suggests that a proposition with an attributive (definite) NP could "invoke" a referential reading. Now consider example (33).

(33) Every time that the horse on which I bet wins, Hans has foreseen it. (H 1991: 18)

The reading of interest for Heim is the one where Hans foresaw that Fortuna, Silver Blaze and Eldorado (the three horses I bet on) would win, without knowing that I bet on these horses. This is expressed by the proposition "which is true at *i* if Hans at *i* has foreseen of the horse on which

¹⁶In this section I only consider how valid is Heim's critique of Donnellan's explanation. I do not evaluate the arguments by Abbott (1993, 1995) or Reinhart (1994, 1995) who argue for a pragmatic explanation.

I bet at *i* that it will win" (1991: 18). She says *the horse* cannot be referential "since it doesn't have a referent fixed by the utterance situation" (1991: 18), and therefore *the horse* must be attributive with its scope in the relative clause. But the proposition with *the horse* having an attributive reading and scope inside the relative clause "is true at *i* if the horse on which I place a bet at *i* wins at *i*" (1991:18), which is not the same proposition expressed. Heim uses this as further evidence that the referential reading can be invoked from the attributive reading. Thus also in (32), the proposition *the horse which I bet on won*, with an attributive NP, could invoke the referential reading, without there having to be separate referential and attributive readings.

Another type of evidence is the use of paraphrases. If the readings are attributable to differences in scope, then the ambiguity should disappear in the paraphrases. This would happen because relative clauses and some *that*-clauses create scope islands. In (34a) there are two possible readings depending upon whether *one or two people* or *always* has wider scope. In the paraphrase in (34b), *one or two people* has wider scope and the ambiguity disappears. In the paraphrase in (34c), *always* has wider scope and the other reading disappears.

- (34) a. One or two people are always late (H 1991: 17)
b. There are one or two people who are always late
c. It is always the case that one or two people are late

However this is not what happens with the ambiguity of definite NPs when paraphrased. In (35) *the player on the left* can be interpreted referentially where it refers to the player, whether he stands on the left or on the right, or *the player on the left* can be interpreted attributively where it means that whoever stands on the left will win.

- (35) The player on the left always wins (H 1991: 17)

If there are separate readings then paraphrasing should get rid of the ambiguity. For example in (36) when *always* has wide scope, *the player on the left* should have only the attributive reading. But this is not the case. Although the attributive reading is the preferred one in (36), the referential reading is still possible.

(36) It is always the case that the player on the left wins (H 1991: 17)

Although this would support a Donnellan analysis of the existence of two separate readings, Heim provides the example in (37) to show that the referential reading can arise from an attributive one. (The argument is similar to her explanation for the rejection of separate readings with the proposition-anaphor *it* illustrated in (33).)

(37) Each time, it could have happened just as easily that the player on the left would have been on the right (H 1991: 19)

The reading in (37) that is of interest to Heim is the one where "for every time *t*, the player who in fact is on the left at *t* could just as easily have wound up on the right". *The player on the left* must be attributive in order to pick out different players at different times, at the same time *the player on the left* must be outside the scope of the modal operator *it could have happened just as easily*: "since we are not, after all, discussing possible worlds in which the player who is on the left there is simultaneously on the right." This shows that the scope of attributive definite NPs can escape embedded clauses, and thus two separate readings of definite NPs need not be postulated.

Her rejection of a separate referential reading with anaphoric-*it* and with paraphrases is based on her explanation for the interaction of the sentential operator *every time* in (33) and *each*

time in (37) with the NPs *the horse on which I bet wins* and *the player on the left* respectively. She says these definite NPs cannot be referential since there is not a referent that is fixed by the utterance situation, instead they must be attributive with the referential reading invoked through pragmatics. However, for *each time* considered, the speaker has a particular (different) entity in mind, so the definite NPs can have a referential reading in examples (33) and (37). Thus these two types of evidence against Donnellan are not valid.

A third type of evidence Heim provides is that the referential reading can be obtained as a subcase of the classical reading, with knowledge of the context of the utterance. She illustrates this with Kripke's explanation for deriving the two interpretations of the sentence in (38).

(38) Please throw out the man with the martini!

For the command in (38), the content (=attributive reading) can be described as in (39) (see Heim 1991: 14).

(39) - inexecutable in *w* if there isn't exactly one man drinking a martini in *w*;
- obeyed in *w* if B throws out in *w* the unique man drinking a martini in *w*;
- disobeyed in *w* if B doesn't throw out in *w* the unique man drinking a martini in *w*.

The referential reading is obtained from the interaction of (39) with pragmatics. The hearer infers a certain desire of the speaker. If *the man* really has a martini, the order is obeyed as described in (40). If *the man* has, for example, water instead of a martini, the hearer needs to know the external circumstances of the utterance and the speaker's mind to guess what the speaker wants and to carry out the order, which is also described by (40) (see Heim 1991: 14).

(40) - fulfilled in *w* if B throws out E in *w*;
- unfulfilled in *w* if B doesn't throw out E in *w*;
(and perhaps: unfulfillable in *w* if E or B doesn't exist in *w*.)

Thus knowing the context/utterance situation allows for the referential reading.

Although Heim (and Kripke) may be able to describe a context in which a referential reading is obtained, this does not mean that pragmatics is interacting with the attributive reading to yield that referential reading. And if it were just pragmatics there would be no effect on the semantics; yet in Section 2.4.1 we saw that there was a difference in the truth values and in the types of questions that could be asked when sentences had referential versus attributive NPs.

The difficulty in conclusively showing that Donnellan's analysis in which there are two readings is the correct one is because the logical structure of a sentence "is determined to a large extent, if not completely, by its syntactic structure" (Heim 1991: 17), yet the scope options of definites do not seem to distinguish syntactically between a referential and an attributive use. Previously in Generative Grammar S-structure and LF were separate levels that contributed to the logical structure of a sentence. But in the Minimalist Program there is just the conceptual-intentional interface and where Spell-out occurs. Since Spell-out occurs before movement of specific NP objects in English, they move covertly to take wide scope. Thus the scope options appear not be constrained, yet at the same time they support a relationship between the logical structure of the sentence and the syntactic structure. Section 2.5 will show that specific NPs (referential) move covertly to take wide scope in accusative languages whereas they move at Spell-out in ergative languages.

2.4.4 Summary

Object NPs in English can be specific or non-specific. The speaker's intention to pick out a particular NP makes it specific. Since movement of specific objects does not occur until after

Spell-out in English, there are two possible readings of definite NPs since there are two possible positions for interpreting definite NPs: the S-structure *in situ* narrow scope reading and the wide scope reading from movement after Spell-out. If the speaker uses the definite NP to pick out a particular object it will take wide scope covertly and have a referential reading. If the speaker does not refer to any particular object the NP is used attributively and remains *in situ*, retaining its narrow scope. An opaque context makes the non-specific reading more salient because the operator takes scope over the definite NP. However a specific reading is still possible with the definite NP taking scope over the operator. Definite pronominals are always specific and make particular reference to something or someone.

In the next section, specificity as described for Inuktitut in Sections 2.2 and 2.3 is compared with specificity for English described Section 2.4. I will show that a specific object moving to take wide scope at Spell-out or covertly after Spell-out accounts for a language being ergative or accusative.

2.5 Specificity in Ergative and in Accusative Languages

From the description of Inuktitut in Sections 2.2 and 2.3 and of English in Section 2.4, specific objects in ergative and in accusative languages mark a speaker's intentions to pick out a particular entity. Modern Farsi is another example of an accusative language that marks objects as specific. S. Karimi (1989, 1990) describes *rā* as a syntactic marker of specificity, and argues that it is a syntactic representation of a semantic idea that the speaker has a specific individual in mind. She defines specificity as the speaker's intention to select a particular individual (or individuals) from

a set of entities, and shows that *râ* does not have a discourse function.

For the description of English in Section 2.4, definite objects were shown to have two readings: a specific (referential) and a non-specific (attributive) reading. The former is unmarked and the latter becomes more salient when the sentence contains an Operator. Similarly in other accusative languages a specific object can have two readings. In the Farsi example in (41a) and in the Bulgarian example¹⁷ in (41b), there are two readings: one referential and one attributive. For the referential reading, the hearer interprets the speaker as picking out a particular book, and if the book is on the floor it could still be brought or questions which make reference to a particular book could be asked such as *do you mean the book on the floor?* For the attributive reading the hearer might say *there's no book on the table* or *well there's a pencil on the table, there's no book.*

- (41) a. ketaab.e ruye miz.ro bar.aam biyaar
book.EZ on-EZ table.râ for.me bring
'Bring me the book on the table'
- b. donesi mi kniga.ta na masa.ta
bring-2sg me-CL book.Def on table.Def
'Bring me the book on the table'

The difference between specific objects in ergative and accusative languages lies in the readings available. In accusative languages (e.g., English, Modern Farsi, Bulgarian), objects can have a specific (referential) reading or a non-specific (attributive/non-referential) reading. The specific reading is preferred, and the non-specific becomes more readily available if there is an

¹⁷The two readings for sentences in (41) were obtained from adult native speakers of Farsi and Bulgarian.

operator in the sentence. However in ergative languages (e.g., Inuktitut and West Greenlandic), specific objects can have only one reading even if there is an operator in the sentence.

In Inuktitut a specific NP has only the wide scope (specific/referential) interpretation¹⁸ (see also Bittner (1987) for West Greenlandic). In (42a) there is only the reading where there is a particular ski-doo that Mary wants to buy.

(42) a. Maari.up sikituuq niuvi.ruma.janga
 Mary.Erg/Gen ski-doo(Abs/Nom) buy.want.IND3E/3A
 'Mary wants to buy the ski-doo'

b. qajaq atu.runnaar.paa (B 1987: p. 211)
 kayak(Abs/Nom) use.no-longer.IND3E/3A
 'He no longer uses kayak'

In the West Greenlandic example in (42b) there is only the wide scope reading as in (43a) and not the narrow scope reading in (43b).

(43) a. $\exists x[x \text{ is a kayak \& it is no longer the case that (he uses } x)]$ (B 1987: p. 211)

b. it is *no longer* the case that ($\exists x[x \text{ is a kayak \& he uses } x]$)

It is only with non-specific NPs that there is the narrow scope reading. Thus in (44a) there is the narrow scope reading as in (44c), but because of the opaque operator *-juma-* there is also the wide scope reading in (44b).

¹⁸Part of Campana's (1992) argument for arguments in ergative languages being in base generated argument positions at S-structure (Spell-out) and moving at LF to their case positions is based on the scopal properties of Abs objects versus Inst objects. He says "according to Bittner (1987), transitive objects in West Greenlandic always have scope over modals of necessity (e.g. *must*), whereas antipassive objects (Themes) with oblique Case never do" (Campana 1992: 110). Now although Bittner (1987) describes the Inst/Acc NP as not taking wide scope over the modal of necessity, with almost all of the other operators the Inst NP could take narrow scope or wide scope. However an Abs/Nom NP object always takes wide scope which would indicate that the Abs/Nom NP object has moved outside the VP by Spell-out.

- (44) a. Maari sikituu.mik niuvi.ruma.juq
 Mary(Abs/Nom) ski-doo.Inst/Acc buy.want.IND3A
 'Mary wants to buy a ski-doo'
- b. qaukpat niuvir.niaq.tanga
 tomorrow buy.FUT.IND3E/3A
 'she will buy it tomorrow'
- c. qaukpat niuvir.niaq.tuq
 tomorrow buy.FUT.IND3A
 'she will buy one tomorrow'

The example in (45) is from West Greenlandic (Bittner 1987). The non-specific object in Inst/Acc case can have the wide scope reading in (43a) or the narrow scope reading as in (43b).

- (45) qajaq.mik atu.junnaar.puq (B 1987: p. 211)
 kayak.Inst/Acc use(+AP).no-longer.IND3A
 'He no longer uses kayak'

There is a similar difference in the readings available for number phrases. Abs/Nom number phrase objects can have only the collective reading while Inst/Acc number phrase objects and Erg/Gen number phrase subjects can have the collective or the distributive readings (see Bittner 1994: 97-104). The following examples are from Bittner (1994: 98, 99).

- (46) a. qimmi.t marluk arna.t pingasu.t kii.va.at
 dog.pl-Erg/Gen two-pl-Erg/Gen woman.pl-Abs/Nom three.pl-Abs/Nom bite.IND.3plE/3plA
 'Two dogs bit three women'
- b. qimmi.t marluk arna.nik pingasu.nik kii.si.pput
 dog.plAbs/Nom two-pl-Abs/Nom woman.pl-Inst/Acc three.pl-Inst/Acc bite.AP.IND3plA
 'Two dogs bit three women'

Three women in both (46a) and (46b) have the collective reading where there were three women that were bitten by two dogs as shown in (47a).

- (47) a. $\exists y(*\text{woman}'(y) \wedge \text{three}'(y) \wedge \exists x(*\text{dog}'(x) \wedge \text{two}'(x) \wedge \text{bite}'(y)(x)))$

b. $\exists x(*\text{dog}'(x) \wedge \text{two}'(x) \wedge \text{D}(\lambda z[\exists y(*\text{woman}'(y) \wedge \text{three}'(y) \wedge \text{bite}'(y)(z)]))(x))$

However the distributive reading where two dogs each bit three women as shown in (47b) (Bitner (1994: 99)) is only available for the Inst/Acc object in (46b) and is not available for the Abs/Nom object in (46a).

The difference in the readings available is determined by the scope that the specific object has. In ergative languages such as Inuktitut, the specific object takes wide scope at Spell-out, so only the wide scope reading is available. In accusative languages like English and Farsi, the definite object is within the VP at S-structure and only moves covertly after Spell-out. Thus the marked narrow scope attributive (non-specific) reading is possible because the object remains *in situ* at Spell-out, but the unmarked referential (specific) reading occurs when the object takes wide scope after Spell-out.

The Abs/Nom case marking of specific objects in ergative languages is accounted for, and in Chapter 1 I showed that Abs/Nom is assigned by T in a Spec-head relation. Now I will argue that the Erg/Gen case marked subject is *in situ* in a Spec-head relation with V. As pointed out in Chapter 1, the subjects of verbs in certain Japanese constructions receive Gen case *in situ*. The example (51) from Chapter 1 is repeated here as (48).

(48) a. $[_{DP} [_{IP} \text{John-no tabeta }] \text{ pizza }]$ (Mi: eg. 3)
 $[_{DP} [_{IP} \text{John-Gen ate }] \text{ pizza }]$
 'the pizza John ate'

b. $[_{DP} [_{IP} (\text{kinoo}) [\text{John-ka Mary}]\text{-no kita }] \text{ riyuu}]\text{-o osiete}$ (Mi: eg. 13)
 $[_{DP} [_{IP} (\text{yesterday}) [\text{John-or Mary}]\text{-Gen came }] \text{ reason}]\text{-Acc tell me}$
 'Tell me the reason why John or Mary came (yesterday)'

In English, the Gen subject of the gerund is generated in [Spec, V] and is assigned case

by V¹⁹ as illustrated in (49).

(49)

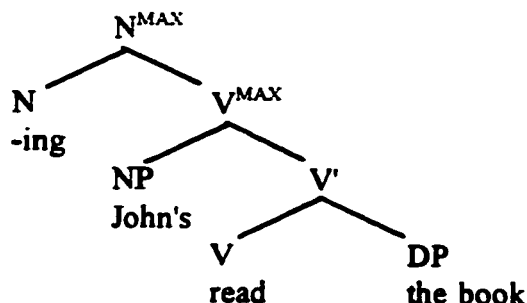

Since the DP hypothesis other explanations for *-ing* gerunds assume that the Gen subject is generated in [Spec, D] (cf. Abney (1987), Yoon (1996a, 1996b)). However, the Gen subject has must be generated in [Spec, V]. Nominals allow the definite article but do not permit PRO as in (50a); whereas gerunds do not allow articles but do permit PRO as in (50b).

(50) a. John's/the/*PRO shipping of the package to England

b. John's/*the/PRO shipping the package to England

Gerunds also do not exhibit N' properties since they do not allow adjectives such as the pronominal negative *no*, but do allow the adverbial negative *not* in (51b).

(51) a. no/*not recording of the song can compare to a live performance

b. John's *no/not recording the song created a great furor

Libert (1992) points out that genitive subjects of gerunds can have predicates as in (52b), whereas genitive subjects of nominals as in (52a) get mixed judgements.

(52) a. *John's, destruction of the paintings drunk, was a crime

¹⁹Chomsky (1986a: 195) had the VP *reading the book* assign a theta-role and case to *John*, thereby satisfying the Uniformity Condition.

(i) [John's reading the book] disturbed me (C 1986a: 195)

Recall that this was before the VP-internal subject hypothesis.

b. John's, destroying the paintings drunk, was a crime

Finally, the Gen subject has must be generated in [Spec, V] since it has an agent thematic role, not a possessor theta role in the (b) examples and in (53) as the object of a passive gerund.

(53) a. John's having been bitten by so many mosquitoes was quite a surprise

b. The car's having been painted blue was an attempt to placate his wife

This suggests that we can consider the Erg/Gen subject in Inuktitut to be in [Spec, V].

Scope facts also present evidence that the Erg/Gen subject is, in fact, *in situ*. Bittner (1994: 101) describes (54a) as having two possible readings. The collective reading where *two men jointly gave Juuna a dog* is shown in (54b); and in this case Juuna gets one dog.

(54) a. anguti.t marluk Juuna qimmi.mik tuni.va.at
man.pl-Erg/Gen two-pl-Erg/Gen Juuna-Abs/Nom dog.Inst/Acc give.IND.3plE/3A
'Two men gave Juuna a dog'

b. $\exists x(*\text{man}'(x) \wedge \text{two}'(x) \wedge \exists y(*\text{dog}'(y) \wedge \text{give}'(y)(j)(x)))$

c. $\exists x(*\text{man}'(x) \wedge \text{two}'(x) \wedge {}^D(\lambda z[\exists y(*\text{dog}'(y) \wedge \text{give}'(y)(j)(z))])(x))$

The distributive reading where *two men each gave Juuna a dog* is shown in (54c); and in this case Juuna gets two dogs. And in the example (59) from Classical Tibetan in Chapter 1, with the negative particle *mi-* the Erg/Gen subject²⁰ could have only the narrow scope reading where the proposition is denied.

I suggest that specificity is a formal feature and it is this feature that is checked with movement. In accord with the Minimalist Program, since formal features checked at Spell-out

²⁰The Erg/Gen subject was 'the king' which did not involve a variable/quantifier as in Bittner's examples.

move the whole NP along for phonological convergence, in ergative languages the whole object NP moves. In accusative languages the whole NP need not move, only the FF[specificity] moves since the feature is checked covertly. The fact that specificity is a feature assigned to an object by the speaker can explain the difference in scope readings for Abs/Nom subjects versus Abs/Nom objects. For example, Bittner (1994:97-104) describes the number phrase with Abs/Nom in the transitive sentence in (55), the passive in (56) and the antipassive in (57) as all having a collective reading (wide scope) for the object as shown in the (b) examples.

(55) a. qimmi.t marluk amat pingasut kii.vaat (B 1994: 98)
 dog.plErg/Gen two(Erg/Gen) woman(Abs/Nom) three(Abs/Nom) bite.IND3plE/3plA
 'Two dogs bit three women'

b. $\exists y(*\text{woman}'(y) \wedge \text{three}'(y) \wedge \exists x(*\text{dog}'(x) \wedge \text{two}'(x) \wedge \text{bite}'(y)(x)))$

(56) a. ama.t pingasut qimmi.nit marlun.nit kii.ni.qar.put (B 1994: 99)
 woman.plAbs/Nom three(Abs/Nom) dog.plAbl two.Abl bite.niq.have.IND3plA
 'Three women were bitten by two dogs'

b. $\exists y(*\text{woman}'(y) \wedge \text{three}'(y) \wedge {}^D(\lambda z[\exists x(*\text{dog}'(x) \wedge \text{two}'(x) \wedge \text{bite}'(z)(x))])(y))$

(57) a. qimmi.t marluk ama.nik pingasu.nik kii.si.pput (B 1994: 99)
 dog.plAbs/Nom two(Abs/Nom) woman.plInst/Acc three.Inst/Acc bite.AP.IND3plA
 'Two dogs bit three women'

b. $\exists x(*\text{dog}'(x) \wedge \text{two}'(x) \wedge {}^D(\lambda z[\exists y(*\text{woman}'(y) \wedge \text{three}'(y) \wedge \text{bite}'(y)(z))])(x))$

However the Abs/Nom object number phrase in (55a) does not allow a distributive reading. Only the Abs/Nom subjects in (56) and (57) allow the distributive (narrow scope) reading. Hence (56) can also mean *three women were each bitten by two dogs* and (57) can also mean *two dogs each bit three women*. The difference then between Abs/Nom objects and Abs/Nom subjects is that the former are marked as specific by the speaker and can only be interpreted referentially.

In summary, specificity is a feature of an object that is used by the speaker when he intends to pick out a particular entity. Ergative languages require the specificity feature to be checked at Spell-out which results in the object moving outside the VP and taking wide scope. The specific object moves outside the VP to [Spec, T] as shown in (58a). For non-specific objects the subject moves to [Spec, T] and is assigned Abs/Nom case in a Spec-head relation with T, while the object is assigned Acc/Inst within the VP with insertion of the postposition *-mik* as shown in (58b).

(58) a. Object is Specific

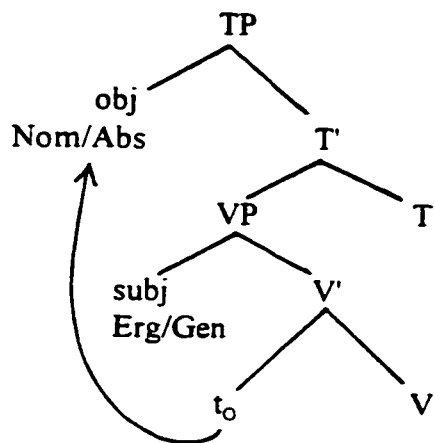

b. Object is Non-specific

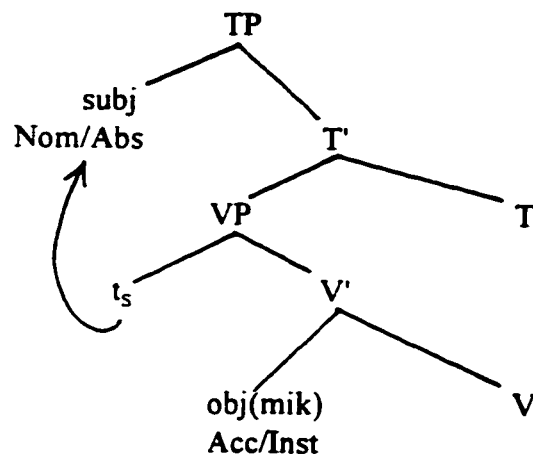

The Spell-out position for English, an accusative language, is illustrated in (59a); compare it with the Spell-out position for ergative languages in (58a). In accusative languages if the speaker picks out a particular entity, he marks the object with a specificity feature which is checked covertly by movement of the feature after Spell-out. Covert checking of the [+specific] feature illustrated in (59b) (see also Section 1.4.2 figure (47)). The choice of the definite article in English and the morpheme *râ* in Modern Farsi will usually indicate a specific object. However, as we saw, it is possible to have a non-specific (attributive) reading. In this case the

attributive reading is possible because the object is inside the VP at Spell-out as in (59a).

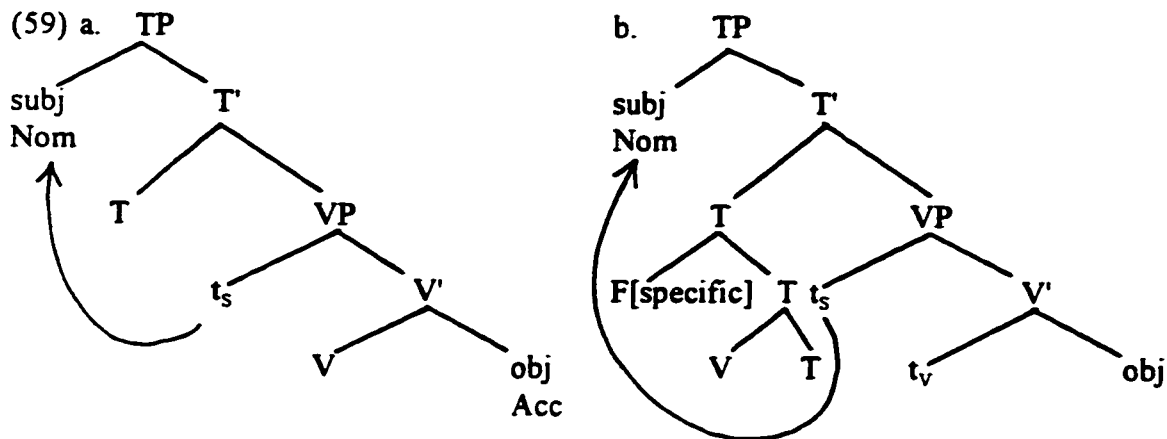

For accusative languages the case is checked by V, however for ergative languages V checks Erg/Gen (in Erg/Gen-Abs/Nom clauses) and cannot check Acc (in Abs/Nom-Inst/Acc clauses) so the postposition *-mik* is inserted for checking Inst/Acc. Ergative languages have been described as unable to assign Acc case. At first glance it might seem that the inability of the V to assign Acc case could be the reason why the object moves to [Spec, T], i.e., to satisfy the case filter. However if this were the reason then it doesn't explain why the option in (58a) is sometimes chosen and sometimes the option in (58b).

Chapter 3

Parametric Explanations for Erg-Abs Case-Marking

Chapter 2 explained the occurrence of Erg/Gen-Abs/Nom versus Abs/Nom-Inst/Acc case marking in Inuktitut by the requirement of specific objects to move outside the VP at Spell-out in Inuktitut. There are other models which use parameters to explain the difference between accusative languages and ergative languages such as Inuktitut. Different parametric explanations that have been posited to account for ergative languages include those by Johns (1992), (1993); Murasugi (1992a), (1992b); and Bobaljik (1993). In this chapter I outline these different parametric explanations for why Inuktitut has Erg/Gen-Abs/Nom case marking and show what is wrong with each. The analysis provided in Chapters 1 and 2 of my study eliminates the need for a special parameter. I also look at the case-binding configuration explanation for case marking patterns in Bittner (1994a) and Bittner and Hale (1996) and show the difficulties it has in accounting for Inuktitut data, which suggests that case assignment is by a lexical head (Chomsky 1986a, 1995) as described in Chapter 1. Lastly I look at Bok-Bennema's (1991) explanation for the dual case marking patterns of Inuktitut. I will show that it also is not the correct account for the case marking in ergative languages.

3.1 Lexical Properties Parameter

Johns (1987, 1992, 1993) takes the nominalist position which posits that there are no VPs in

Inuktitut, only nominals. Though there are Vs and Ns, Vs do not project to VPs. The mood phrases are really nominalizing affixes which attach to Vs in the lexicon. The transitive mood affixes (e.g., *-jaq*) carry a referential feature.

Johns (1992) attributes the difference between the ergative language Inuktitut and languages that have a VP in syntactic structure to parametric variation in lexical properties which is informally stated in (1).

(1) Lexical Properties Parameter:

Ergativity in Inuktitut results from the interaction of universal principles with the following 3 language particular features: (i) V cannot project a VP, (ii) passive participle morpheme is nominal and creates a predication relation, and (iii) only 2 functional nodes, nominal agreement AgrP_N and predicate level agreement AgrP_V , are available.

The third point in the parameter is based on the assumption that the type, number and position of functional categories can vary from language to language (cf. Chomsky 1991). Inuktitut has at most the two functional projections of AgrP_V (=IP) and AgrP_N (=NP) as shown in (2). An intransitive clause has only the former and transitive clauses can have both. The first two points are explained by Johns' (1992) assumption that substantive categories (Ns and Vs) are also subject to parametric variation. This latter assumption is used to explain (i) the predication relation created between a "transitive" mood nominalized complement of Agr_N and the subject in [Spec, Agr_N], and between the nominal phrase complement AgrP_N and the subject in [Spec, Agr_V]; and (ii) V not projecting a VP and thus not projecting an object (the object is generated as subject of the predicate phrase AgrP_V).

An illustration is provided in (2). The thematic arguments are generated in [Spec, AgrP]: in intransitive clauses the thematic subject in [Spec, Agr_V], and in transitive clauses the thematic

subject in [Spec, Agr_N] and the thematic object as subject of the predicate phrase in [Spec, Agr_V]. The overt NPs get case¹ through Spec-head agreement with the agreement heads Agr_N and Agr_V. The deverbal nominal (= the complement of Agr head) moves to the agreement heads through head movement and gets the agreement endings.² The overt subject NP in transitive clauses adjoins to AgrP_V to check agreement features at S-S.

(2) a. Intransitive Clause

anguti taku.juq
 man(Abs/Nom) see.IND3A
 'the man sees'

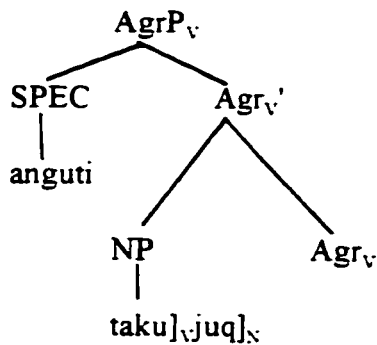

b. Transitive Clause

anguti.up armaq taku.ja.a
 man.Erg/Gen woman(Abs/Nom) see.IND.3E/3A
 'the man sees the woman'

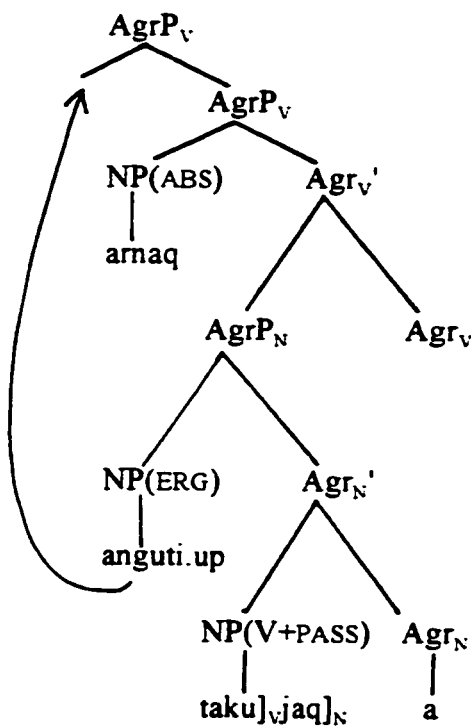

¹For a description of case in Eskimo-Aleut languages in the nominalist tradition of Kleinschmidt, Thalbitzer, Hammerich, see Johns (1987). For a critique of the nominalist position, see Lipscomb (1993).

²I will not discuss Johns' (1993) analysis of participial versus indicative mood affixes in one sub-group of speakers of Labrador Inuttut.

There are problems both with this nominal model and with the parameter. First, a nominal model would require all syntactic relationships to be represented in word formation. All mood markers, including interrogative, would have to be nominalizing affixes since the same case assignment and similar agreement morphemes also occur with moods other than just the indicative (her passive morphology) as shown in (3).

(3) a. taku.gu.ni.uk
see.COND.3ssE.3A
'if he sees her'

b. pi.gasuk.piuk? (S I: p. 105)
get.try.Q2E/3A
'Did you try to get it?'

As well, material such as auxiliaries as in (3b) and adverbs and negation as in (4) can occur between the V and the nominalizing morpheme.

(4) tigu.qatta.nngi.li.ruk (S I: p. 90)
take.often.NEG.process.OPT2E/3A
'don't keep grabbing it'

It is also unclear how her model would handle the Abs/Nom-Inst/Acc sentences in the (b) examples in Section 2.2.1.

Johns' explanation for ergativity, however, makes two wrong predictions. As shown in Sections 2.2 and 2.3, speaker intentions to pick out a particular entity accounts for the Erg/Gen-Abs/Nom case marking. According to the parametric variation of lexical properties, speaker intentions would have to be marked in the lexicon on the transitive mood nominalizers. Now although other languages such as English and Modern Farsi mark specific objects in syntax using the determiner *the* and the morpheme *râ* respectively, Inuktitut would mark specific objects in the lexicon. This is, of course, consistent with the observation that syntactic relationships would

occur in word formation. However if this really were the case, then words formed with the *-jaq* nominalizer (her passive participle morpheme) as in (5) would be specific.

- (5) a. *sana.juq* 'he works on something' (S II: p. 96)
 b. *sana.jaq* 'thing made or worked on (handicraft, carving)

Moreover, Johns (1992: 84) posits a "One Form/One Meaning Principle", in part to justify treating the nominalizer *-jaq* and the *-ja-* mood marker as the same nominalizing affix, which would require morphemes that are identical or similar phonologically to have identical or similar lexical properties. However *-jaq* nominals need not be specific as shown in (6). In (6a) *takujaq* is the subject of a copula verb (i.e., passive); in (6b) *sanajaq* is a non-specific object; and in (6c) *sanajaq* is a non-specific object even though it has a possessor subject.

- (6) a. *takuja.u.juq* Nali.mut (S I: p. 112)
 seen-thing.be.IND3A Nellie.Abl
 'it was seen by Nellie'
- b. *sanajar.mik* *taku.lauq.punga*
 thing-made.Inst/Acc see.PAST.IND1A
 'I saw the thing someone made'
- c. Maari.up *sanaja.nga.nik* *taku.lauq.punga*
 Mary.Gen(Erg) thing-made.3POSS.Inst/Acc see.PAST.IND1A
 'I saw Mary's made thing'

One could argue following Johns (1992) that just as the copula transmits the referential feature of the nominalizing mood affix, the copula assigns the [+specific] feature; thus associating specificity with [Spec, AgrP_v]. But this would not be correct as an Abs/Nom NP need not be specific as shown in (7) where it is clearly undesirable to associate Abs case with speaker intentions.

- (7) a. *pi.u.juq*
 good.be.3Abs/Nom
 'it is good'

- b. uqquu.juq
 be-warm.3Abs/Nom
 'it is warm'

The deverbal nominal can be used non-specifically as in (6b) and (6c) and so cannot have a [+specific] feature as part of its lexical entry. Nor can the retention of a [+specific] feature be related to the AgrP_N projection since AgrP_N is the structure Johns (1992) has for the possessive phrase, and the possessive construction can also be non-specific as shown in (6c).

Secondly according to the Lexical Properties Parameter the syntactic structure for the sentence in (8a) is (8b) with the semantic interpretation in (8c) (see Johns 1992: 61).

- (8) a. anguti.up nanuq kapi.ja.a.0
 man.Erg/Gen bear(Abs/Nom) stab.IND[PassPart]3E.3A
 'the man stabbed the bear'

- b. the man is the bear's stabbed one
 c. the man stabbed the bear

It is generally assumed as part of UG that meaning, though compositional, is related to syntactic structure. If the meaning is read off (8b), then *the bear's stabbed one* should have a specific and a non-specific reading (cf. Donnellan 1966, 1978; Manga 1994a). But *nanuq* 'the bear' with Abs/Nom case in (8a) has only the specific reading as already discussed in Section 2.3.2 (see also Bitner (1994a) and Section 3.4). Thus (8b) cannot be the syntactic structure for Erg/Gen-Abs/Nom sentences as in (8a).

3.2 Obligatory Case Parameter

Unlike the models in the following Sections 3.3, 3.4 and 3.5 that associate the marked cases Erg and Acc and the unmarked cases Abs and Nom, Bobaljik's model structurally associates Erg with Nom and Abs with Acc. (This parameter has already been discussed in Chapter 1, Sections 1.4.1

and Section 1.4.2.) There are two AgrP functional projections. The higher AgrP is associated with Nom/Erg case and the lower AgrP with Acc/Abs case. The difference between Erg languages and Nom languages thus lies with the intransitive verbs. With Erg languages Agr₂P (Abs case) is obligatory and with Nom languages Agr₁P (Nom case) is obligatory. Bobaljik (1993: 51) formulates this in terms of the Obligatory Case Parameter in (9).

(9) Obligatory Case Parameter:

Case X is obligatorily assigned/checked, where Case X is a structural case.

- a. In N/A languages, CASE X is NOMINATIVE (=ERG)
- b. In E/A languages, CASE X is ABSOLUTIVE (=ACC)

Bobaljik's model for transitive and intransitive verbs is given in (10a) and (10b) respectively. For transitive verbs as in (10a) the object moves to [Spec, Agr₂] where it gets Abs case, and the subject (agent) moves to [Spec, T] then to [Spec, Agr₁] where it gets Erg case. Features are checked through Spec-head agreement.

(10) a.

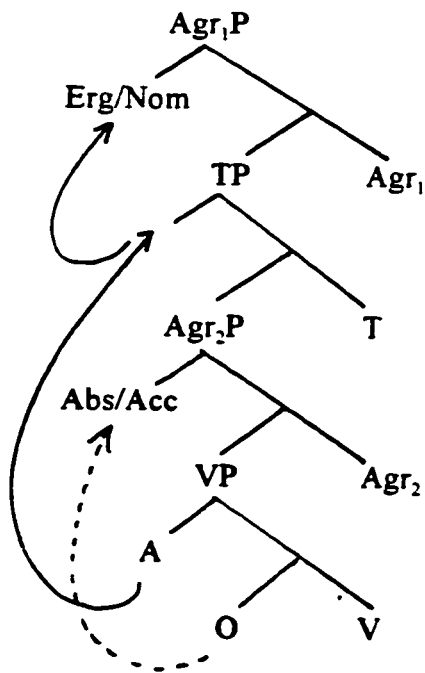

b.

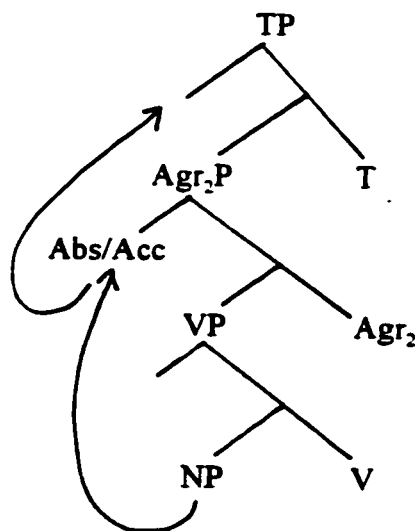

For intransitive verbs in ergative languages the only NP argument moves to [Spec, Agr₂] due to the Obligatory Case Parameter, then moves to [Spec, T]. This is shown in (10b).

Bobaljik claimed his model and parameter were supported by anaphoric binding in Erg/Abs clauses and by agreement patterns in [-Tense] clauses. However, neither the binding data nor his analysis of [-Tense] clauses show that Agr₁P and Agr₂P need be associated with Erg(=Nom) and Abs(=Acc) cases respectively. As noted in Chapter 1, anaphoric binding in ergative languages follows a Nom-Acc language pattern. Other models such as Bittner's (Section 3.4) which have Agr₁P for Abs case can also account for the binding facts. So Bobaljik's Obligatory Case Parameter where the subject and object arguments respectively move in S-structure to [Spec, Agr₁] and [Spec, Agr₂] is not necessary to account for anaphoric binding.

In Bobaljik's analysis of [-Tense] clauses, Agr₁P in Nom-Acc languages is defective when there is no T feature, but Agr₂P can be active. Thus there is no Nom case or agreement but there can be an object as shown in the English example in (11).

(11) John tried PRO/*John/*him to leave/congratulate himself/Archibald/... (Bo 1993: p. 61)

Since Agr₁ in ergative languages checks Erg case, then in [-Tense] clauses it is expected that there are no Erg arguments. However, since Agr₂ checks Abs case, he predicts and attempts to show that [-Tense] clauses allow only Abs case marking and agreement (either of object if transitive or subject if intransitive). His argument is based on agreement patterns, i.e., there should only be Abs agreement in [-Tense] clauses. However this is clearly not the case.

What Bobaljik calls a "gerundive clause" is a dependent mood also called participial (Mallon 1991, Spalding 1992), conjunctive (Lowe 1985), appositional (Dorais 1988), or contemporative (Fortescue 1984). This dependent mood distinguishes non-future (-*l*)/*lu*-) from

future (-*lu-*) and indicates whether the subject is the same (-(*l*)*luni*) or different (-*tit+lugu*)³ from a related clause as illustrated in (12).

(12) a. *kingaq urnik.&u.ni.uk, sina.a.nut kinga.up ingi.&u.ni* (S I: p. 121)
 hill(Abs/Nom) approach.PART.3ssE.3A, edge.3POSS.Abl hill.Erg/Gen
 sit-down.PART.3A
 '(she,) approaching a hill, she, sat down at the edge of it'

b. *sila.tsia.ngu.til.lugu aulla.lauq.tut* (M 1991b: p. 40)
 weather.good.be.tit(=ds).PART3A depart.PAST.IND3pl
 'the weather being good, they departed'

In the participial clause in (12a) there is agreement for both the subject and the object. The paradigm in (13a) for the participial mood in Inuktitut (see Mallon 1991) shows that though there is only object (Abs/Nom) agreement when the subject is first or second person, with a third person same subject, there is subject and object agreement.

(13) a.	Subject:	1sg	2sg	3ss	3ds
	Non-Specific clause:	<i>lu.nga</i>	<i>lu.tit</i>	<i>lu.ni</i>	<i>til.lu.gu</i>
	Specific clause:	1obj	<i>lu.nga</i>	<i>lu.ni.nga</i>	
		2obj	<i>lu.tit</i>	<i>lu.ni.tit</i>	
		3obj	<i>lu.gu</i>	<i>lu.gu</i>	<i>lu.ni.uk</i>

Furthermore it is also possible for the participial verb agreement endings to have some type of agreement with the first or second person Erg subject. For West Greenlandic Eskimo, Fortescue (1984: 297) writes that "one can find 1st/2nd person subject forms combined with 3rd

³There may be other verbal affixes in Inuktitut besides -*tit-* 'cause' that can be used in participial clauses to indicate that the subject is different from the main clause subject. For example, in West Greenlandic Fortescue (1984: 576-59) has examples as illustrated in (i) and (ii) with both -*tit-* and -*tsir-* 'wait for' being used in the participial clause when the subject in the participial clause is different from the main clause subject.

- (i) (Aggu.mut) *arviq isigi.til.lugu tuqu.vuq*
 'while he, (Aggu) was looking at the whale, he, died'
- (ii) *Aggu.mut taku.tsir.lugu*
 'until Aggu saw the whale'

person object markers, e.g. -(l)lutigu, 1p-3s." In the paradigms for Inuktitut (Dorais 1988, Harper 1974) and Siglit (Lowe 1985), if the object is 3rd person there is number agreement for the subject if it is dual or plural 1st or 2nd person. An example from Siglit for a 1st person subject is shown in (13b) (see Lowe 1985: 219).

(13) b.	Erg subject:	1 singular	1 dual	1 plural
	3 sg object	-lu.gu	-lu.t.ku	-lu.ti.gu
	3 dual object	-lu.gik	-lu.t.kik	-lu.ti.gik
	3 pl object	-lu.git	-lu.t.kik	-lu.ti.gik

The presence of agreement does not mean the subject couldn't be PRO. Chomsky and Lasnik (1995: 119) point out that PRO has ϕ features for agreement as illustrated in (14).

- (14) a. I want [them_i to be officers_i]
 b. *they want [me to be officers]
 c. they_i want [PRO_i to be officers_i]
 d. Juan_i cree [PRO_i estar enfermo_i]
 Juan believes [(himself) to be sick]

And PRO is also associated with null case, so, if the subject is PRO, you should not have an Erg case marked subject. But we will see that an overt subject of a participial can have Erg/Gen case.

There is no empirical evidence to support Bobaljik's Obligatory Case Parameter, however there is evidence against his model. First, contrary to Bobaljik's assertion, an overt subject in the participial clause can have Erg case as shown in (15) with examples from Siglit, West Greenlandic and Inuktitut. In the Siglit example (15a) from Lowe (1985: 230),⁴ *Ilruq* is a

⁴In Murasugi (1992) the participial mood is also considered as non-finite. However she describes the -(l)lu- clauses as having Erg subjects and Abs objects (see Section 3.3). Bittner

person's name and *-m* is the Erg (relative) case marker in Siglit. In (15a) *Ilrum* could be the subject of the main clause *iga.yaa*, however in the West Greenlandic example in (15b) and the North Baffin example in (15c) the Erg subject of the participial clause could not be the subject of the main clause. In (15b) the subject of the participial clause is *Kunuu.p*, i.e., 'Kunuuk' which has Erg/Gen case. The Erg/Gen case marked subject *Kunuu.p* could not be the subject of the main clause which is an intransitive verb. The subject of *aallar-* would be *pro* which refers to *Kunuuk*. Similarly the Erg subject *tatsuma* in (15c) could not be the subject of the main clause verb which is intransitive. Nor could the singular demonstrative *tatsuma* be an Gen/Erg possessor of the Abs/Nom object since the object already has a demonstrative and is dual and not singular.

- (15) a. *Ilrum kivgaluk amiiqaaq.&ugu, iluiq.&ugu, uuk&i.blugu, salummaq.&ugu iga.yaa*
Ilruq.Erg/Gen muskrat(Abs/Nom) skin.PART3E/3A gut.PART3E/3A cut.PART3E/3A
clean.PART3E/3A cook.IND3E/3A
 'Ilruq first skinned the muskrat, then gutted it, cut it into portions, cleaned it, and cooked it'
- b. *Kunuu.p ilaga.lugit aallar.puq* (F 1984: 151)
Kunuuk.Erg/Gen accompany.PART3E/3plA leave.IND3A
 'Kunuuk left accompanying them'

(1994a: 78) and Bittner and Hale (1996: 18) also describe *-lu-* clauses as being able to have Erg case marked subjects, and as not having Erg agreement, which they explain as case and agreement being independent. Bok-Bennema (1991: 206) citing Fortescue's example in (15b) also allows Gen/Erg subjects. Bobaljik (1993: 67) has an example similar to (15a) which was taken from Fortescue (1984) for West Greenlandic. The relevant first part is given in (i):

- (i) *savaati.mi ilisara.lu.ni miirtur.vigi.lir.manni ...*
sheep.3PossRefl(Erg/Gen) recognize.PART.3ReflA bleat.have-as-place-of.begin.CAUS3plE/3A
 'When his sheep, recognizing him, began to bleat at him...'

There is an Erg/Gen case marked subject *savaati.mi* where *-mi* is the 3rd reflexive possessor in Erg case. As with (15a) it could be arguably said that *savaati.mi* is the subject of *miirturvigilirmanni*. However (15b) shows that it is possible to have an Erg case marked subject with a participial mood clause.

- c. tatsuma taikkua nanu.uk malik.til.lu.ni.gik, silattiavau.lauq.tuq
 this-one-right-here(Erg/Gen) that-one-there-away(d,Abs/Nom) polar-bear.d(Abs/Nom)
 follow.tit.PART.3E.3dA, weather-be-fine.PAST.IND3A
 'while this one right here was following those two bears over there, the weather was nice'

Second, if case is assigned/checked in a Spec-head relation with the appropriate Agr, and if Abs case is checked against Agr₂ then Agr₂ would have Abs agreement, and if Erg case is checked against Agr₁ then Agr₁ would have Erg agreement. According to the Obligatory Case Parameter model, the order of the agreement and T features in (10a) would be as in (16a). However this violates the Mirror Principle which posits a relationship between the ordering of morphemes and syntactic derivation, as the actual morphological order is in (16b). The actual morphological order is illustrated in (16c) and (16d) with indicative mood endings that overtly mark singular subject and singular object.

- | | |
|------------------|------------------|
| (16) a. syntax: | V-Abs-T-Erg |
| b. morphology: | V-T-Erg-Abs |
| c. taku.ja.a.nga | d. taku.ja.a.tit |
| see.IND.3E.1A | see.IND.3E.2A |
| 'he saw me' | 'he saw you' |

Although the validity of the Mirror Principle has been questioned (cf. Miller 1993), the discussion is more in terms of what part of morphology is mirrored in the syntax and what part is lexical. In Bobaljik's model the morphology corresponds to three functional projections, i.e., syntax, and so it is expected that the morphological ordering should mirror the syntactic relationship of the functional projections.

Third, the scope facts described in Chapter 2 do not support an analysis in which the Erg/Gen subject is in [Spec, Agr₁] and the Abs/Nom object in [Spec, Agr₂]. The Abs/Nom object has only wide scope and the Erg/Gen subject can have narrow or wide scope which is the

particular entity were picked out; and gave examples of specific and non-specific transitive sentences in (5) to (10). An example of a sentence in the participial mood with a non-specific object is in (18a) and with a specific object in (18b).

(18) a. nanur.mik malik.&utit aullaq.tutit (M 1991b: p. 50)
polar-bear.Inst/Acc follow.PART2A leave.IND2A
'following a polar bear, you left'

b. nanuq malik.&ugu aullaq.tutit (M 1991b: p. 50)
polar-bear(Abs/Nom) follow.PART2E/3A leave.IND2A
'following the polar bear, you left'

He does not address "split" ergativity whereby one language may have either ergative case marking or accusative case marking, however "split" ergativity provides further evidence that the Obligatory Case Parameter is wrong. There are three possible ways to reconcile the Obligatory Case Parameter with split ergativity, but none are successful. First if option b, CASE X is ABSOLUTE, is selected then there is no way to account for the Nom and Acc case marking. If both option a or b could be selected in one language (a for the Nom-Acc marking; b for the Erg-Abs marking), the selection of Abs marking for real intransitive clauses would not be explained since either option should be available. This itself is not problematic since both Nom and Abs are the unmarked cases. However it would pose problems for UG and for learnability having two different structural cases associated with one agreement phrase. A third option might be to disassociate the parameter from assignment of Erg/Nom in Agr₁ and Abs/Acc in Agr₂. However this parameter would then become merely a stipulation and Abs would not need to be associated with Acc or with Agr₂.

By linking Erg with Nom and Abs with Acc it misses two fundamental generalizations in the literature. First both Nom and Abs are unmarked cases. Second the Abs object acts like

the subject of the sentence (cf. Dorais, Mennecier).

3.3 Transitivity Parameter

Murasugi (1992a) has the functional projections TP (tense phrase) and TrP (transitivity phrase) rather than subject and object agreement phrases.⁶ Agreement is "a SPEC-head relation between a verb and its argument, mediated by T or Tr" (1992a: 14). Case requirements are satisfied at Spell-out or LF by the argument moving to a Spec position. The difference between ergative and nominative languages is with the features associated with the functional projections. This is stated in her ergative parameter (1992a: 221) in (19).

(19) Transitivity (Ergative) Parameter:

In an accusative language, the Case features of T [tense] are strong.

In an ergative language, the Case features of Tr [transitive] are strong.

This parameter plus the Principles of Economy for NP movement (move the closest NP available, move to the closest available target, procrastinate) account for the Nom-Acc case marking as in (20a) and the Erg-Abs/Nom case marking as in (20b). In accusative languages T is strong and the closest NP which is the subject NP₁ must raise to [Spec, TP]. The object NP₂ moves to [Spec, TrP] at LF resulting in crossing paths. With transitive verbs in Erg languages, strong Tr features and Economy Principles cause the closest NP, the subject NP₁, to move to [Spec, TrP] at Spell-out. Since T is not strong in ergative languages, the object NP₂ remains inside the VP

⁶Murasugi uses Nom to refer to both Abs and Nom cases in (1992a) (for her explanation, see pp. 195-196), but the term Abs in (1992b).

and moves to [Spec, TP] at LF creating nested paths.⁷ With intransitive verbs the subject moves to [Spec, TP] at LF since "the s-structure requirement for raising applies only to Tr" (Murasugi 1992a: 41).

(20) a. Nominative Language (crossing paths) b. Ergative Language (nested paths)

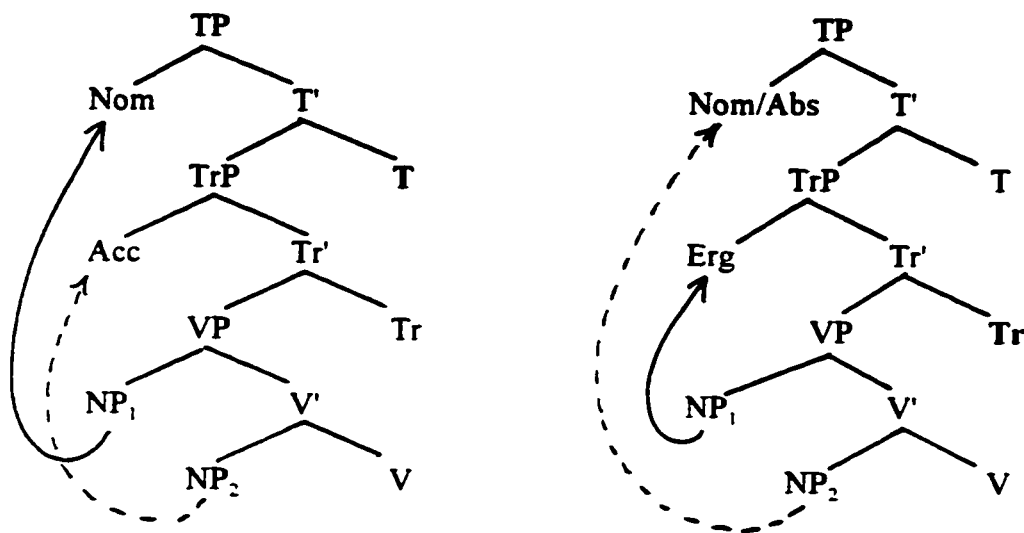

In ergative languages, since Tr is strong there is movement of the thematic subject at Spell-out and since T is not strong there is movement to [Spec, TP] of the thematic object only at LF. However there is no evidence presented that the subject has to move to a lower functional projection other than being just a stipulation of the parameter, nor any evidence that the object does not move until LF. For example, according to her parameter the subject c-commands the object thereby accounting for Control and anaphoric binding facts in Inuktitut. However, as already mentioned for the Obligatory Case Parameter in Section 3.2, examples of anaphoric binding are not a reliable diagnostic as anaphoric binding is applicable at LF (Chomsky 1992),

⁷Both Inuktitut and Mam (a Mayan language) are ergative and the subject moves to [Spec, TrP] at S-structure, but in Inuktitut, which is SOV, the verb remains in the VP at S-structure, while in Mam, which is VSO, the verb raises to T at S-structure (Murasugi 1992a: 39).

and very different models also claim to account for the binding data (cf Manning (1992) and, for Inuktitut, Bobaljik (1992) and Bittner (1994)). In fact scope facts would indicate that the object moves at Spell-out and not LF. The Nom case marked object in Erg/Gen-Abs/Nom sentences has only wide scope as do Nom arguments in general in other languages (Bittner 1987). The Transitivity Parameter would predict that, if the Nom/Abs object were *in situ* at Spell-out and moved to [Spec, TP] at LF, there would be two scope readings--one narrow from the S-structure position and one wide from the position at LF. Murasugi (1992a: 105) acknowledges this deficiency in her model and admits that she does not have an alternative proposal. Thus the Transitivity Parameter, although not disproved by anaphoric binding, is not supported by the scope facts.⁸

This model assumes that V adjoins to Tr and [V+Tr] adjoins to T and that "at each functional node, the verb checks the agreement and tense/transitivity features....Agreement features which are closer to the verb are checked first" (Murasugi 1992a: 100). To account for the correct order for sentences such as (21a) would require that TrP be the mood phrase morpheme and that it always be immediately dominated by a phonetically null T. Aspectual and time morphemes and even S-adverbs as in (21a) would have to be between the VP and TrP.

(21) a. *saalagi.niatualir.tanga!* (S II: p. 102)
 beat-in-a-contest."fat chance".IND3E/3A
 'he'll never beat him (that's a joke)!'

b. ... V_{VP}] S-Adv_{AP}] Tr.Erg-agree_{TRP}] T.Nom(Abs)-agree_{TP}]

In order for the Ergative Parameter in (19) to account for the difference between ergative and

⁸I am concerned here only with the evidence from Inuktitut or West Greenlandic that Murasugi (1992a; 1992b) uses. I do not consider how well the evidence supports her parameter for nominative languages.

accusative languages, this ordering of functional categories would have to be applicable for nominative languages--which it isn't. The order of projections should be the same for both accusative and ergative languages if it is really the strength of the functional heads T versus Tr, and the Case features of the functional heads that are distinguishing accusative from ergative languages.

Recall that Murasugi (1992a) describes the subject NP moving to [Spec, TrP] at Spell-out and the object to [Spec, TP] at LF because Tr is strong in ergative languages. Yet the object must be outside the VP at Spell-out to account for the scope facts. Having the object move to [Spec, TP] at Spell-out to account for the scope facts would alter her Transitivity Parameter given in (19) in that for ergative languages both Tr and T would have to be strong with Tr stronger than T. The Transitivity Parameter as in (19) or as just modified, however, provides no motivation for why Tr (or Tr and T) should be strong in Erg languages, nor for why, if Tr has strong features, the marked case is Erg rather than Acc.

This model assumes transitive verbs have Erg/Gen-Abs/Nom case marking and intransitive verbs have only Nom(Abs) marking.⁹ However, as the examples (5) to (10) in Chapter 2, Section 2.1 showed, transitive verbs can have Erg/Gen-Abs/Nom or Abs/Nom-Inst/Acc case marking. To account for the non-specific (b) examples in (5) to (10), the Tr features would have to be not strong, the Economy Principles would target T for the closest NP (the subject), but the remaining NP (the object) would not be able to move to [Spec, TrP] at LF. If the object were to move to

⁹Murasugi (1992a: 33, 44) would consider the (b) examples as involving anti-passivization, with zero as the antipassive morpheme. She terms AP as incorporation in the lexicon with the result that there is only one argument in the VP. Thus the value for Tr is [-trans].

[Spec, TrP], it would get Erg resulting in confusion as illustrated in (22).

(22)		subject	object
	specific:	Erg/Gen	Nom/Abs
	non-specific:	Nom/Abs	Erg/Gen

Table (22) shows the cases that would result for specific and non-specific sentences if both arguments moved to a functional projection to check case with Tr strong for specific sentences and Tr not strong for non-specific sentences. If a subject could have Erg or Nom and an object could have Erg or Nom it would be impossible to distinguish a subject from an object. If the object in non-specific sentences does not move to [Spec, TrP], then why doesn't it move, how does it get case and what is the role of a Tr projection?

The results if the object were to move to [Spec, TrP], but get Acc(Inst) case instead of Erg are illustrated in (23).

(23)		subject	object	language type
	specific:	Erg	Nom/Abs	ergative language
	non-specific:	Nom	Acc/Inst	accusative language

Table (23) shows that if both arguments in specific and non-specific sentences were to move to a functional projection, Inuktitut, and ergative languages in general, would be both an ergative language and an accusative language. Thus the Ergative Parameter is not distinguishing between ergative and accusative languages.

Watai (1996) has used Murasugi's Transitivity Parameter to account for split ergativity in Cree, an Algonquian language, and it is precisely these problems that arise. Although Algonquian languages do not case mark NPs, they have a system of verb agreement morphemes termed Direct and Inverse forms that suggest these languages are ergative¹⁰ (cf. Hewson 1987,

¹⁰Agreement patterns in ergative languages are discussed in Chapter 5.

1991). Watai, using the Transitivity Parameter, says the Direct forms follow a nominative-accusative pattern (crossing path) while the Inverse forms follow an ergative pattern (nested path)--which denies the existence of a language being accusative or ergative.¹¹

This application to a split ergative language shows that the Transitivity Parameter in (19) cannot distinguish between an accusative language and an ergative language. Furthermore it cannot be the content of the Tr node that makes it strong that causes the subject NP to raise to [Spec, Tr] since the Inverse marker is determined by the person hierarchy created by the subject and object.

3.4 Case-Binding Configuration

Bittner's explanation (1994a) for case marking, like my explanation, but unlike the models seen so far in Sections 3.1, 3.2, and 3.3, has the Nom object in [Spec, I] and the Erg subject *in situ* in the VP at S-structure. This accords with her findings that Erg subjects can have narrow or wide scope, while Nom objects have a wide scope reading. Her explanation for how case is assigned, however, is very different from mine. As we saw in Chapter 1, Chomsky (1986a) has the lexical items V, N and I (really Agr in I) assign case, and when the Agr_SP and Agr_OP functional projections were added to the X-bar structure it was the Agr head that checked the case after head movement of the lexical V, N and finite I into Agr. And in the Minimalist

¹¹This association of Direct forms with Nom-Acc case marking and Inverse forms with Erg-Abs case marking is the opposite to what Hewson (1987) describes. The Direct forms ("transitive objective" in Hewson 1987) have an Erg/Gen-Abs/Nom pattern by making the goal/patient "definite", while the Inverse forms have an Abs/Nom-Acc/Inst pattern with an "indefinite" (even though explicit) goal/patient. Even if Watai had treated the Direct forms as ergative and the Inverse as accusative, the same problem in using the Transitivity Parameter would arise.

Program it is the lexical head that checks the case. This is the position that this study also takes, which is supported by the Inuktitut data (see especially the case marking of adnominals, Chapter 4). In Bittner (1994a) and Bittner and Hale (1996), however, case is assigned under government by a head in a structural case-binding relationship.

Bittner (and Bittner and Hale) have two functional heads dominating an NP as in (24a) which parallels the two functional heads dominating a VP as in (24b). The functional nodes dominating VP are CP and IP, and IP is not broken up into separate tense and agreement nodes.

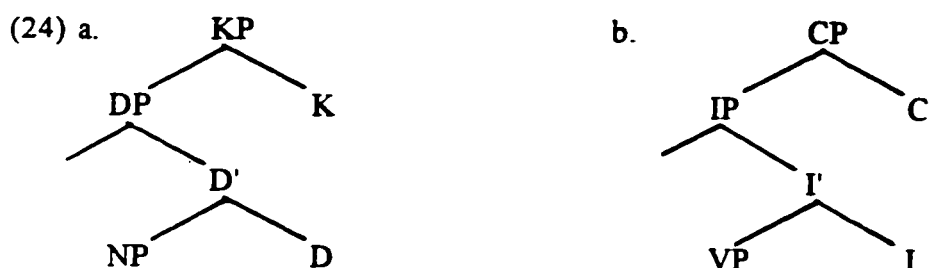

An NP can project to a DP or to a KP case phrase. There are three ways that arguments can satisfy case requirements: by c-selection (structural oblique case), by case-binding (marked structural case), by K (Case) Filter (unmarked structural case). For oblique cases (Inst, Abl, All) the K head is filled at D-structure, being c-selected by a lexical head that governs the KP. For the marked structural case Erg, the K head is empty and case is assigned by I under government in a case-binding configuration. For the unmarked structural Nom¹² "case" only a bare DP or NP is generated and the K Filter (1994a: 9; 1996) ensures that Nom is in a case-chain that is

¹²Bittner (1994a, 1994b) uses Nom for both nominative and absolutive "case". There is actually no nominative case as such. K is a functional head of the case projection of an argument. A nominative argument is a bare DP or NP without a KP case projection, which is constrained by the K Filter in which some node in the bare DPs case-chain must be governed and c-commanded by K or C with no node being case-bound (cf. 1994a: 49). See also Bittner and Hale (1996) where a nominative NP is described, for example, as caseless, and as being eligible to be a case competitor since it is caseless.

governed and c-commanded by C.

There are two terms that are important for case assignment: case-binding configuration and K Filter. A case-binding configuration is illustrated in the assignment of Erg case. In ergative languages the Erg subject (KP) is in the VP¹³ at S-structure and has structural case assigned. Erg case on the subject is assigned in a case-binding configuration¹⁴ which means that there must be a case assigning head that delimits a small clause, a c-commanded argument to get the case, and a case competitor (which is a DP/NP coargument that could potentially get case under government from the case assigning head or is a pseudo coargument). Thus for the sentence in (25a), the head I case-binds KP_i (i.e., it delimits a VP small clause, locally c-commands the KP argument, and there is a case competitor DP_j) and assigns Erg to the empty K as illustrated in (25b).

- (25) a. ama.p atisassat irrur.magit (B 1994a: 18)
woman.Erg/Gen clothes(Nom/Abs) wash.CAUS3E/3plA
'when the woman had washed the clothes...'

¹³Bittner (1994a) generates the subject as a 'distinguished adjunct' of the VP as in, for example, (25a). That is, the subject is within the VP but does not occupy the [Spec, V]. The specifier, complement and distinguished adjunct are A-positions, while she has [Spec, I] as an A-bar position.

¹⁴For formal definitions of case-binding configuration, delimit, locally bind, and case competitor, see Bittner and Hale (1996: 12-13). The VP small clause is not a barrier for I to locally case-bind the (Erg) subject adjoined to VP, because either V incorporates into I, or V and I are coindexed.

b. Erg/Gen-Abs/Nom Sentences

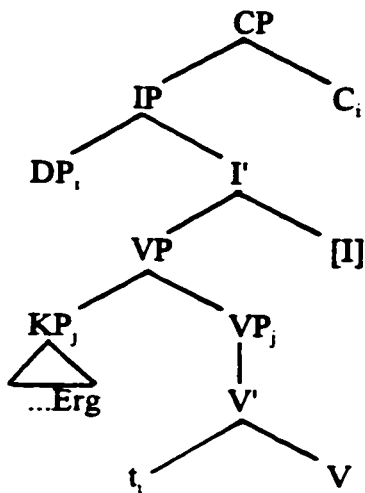

The terms case-chain and K Filter are relevant for nominative arguments. In West Greenlandic, and Eskimo-Aleut in general, the nominative argument raises to [Spec, I].¹⁵ This is illustrated for the Erg/Gen-Nom/Abs sentence in (25) (see Bittner 1994a: 15, 17). The V cannot case-bind the object (there is no case-competitor), so the object is generated as a DP (rather than a KP) which raises to [Spec, I] and forms a case-chain DP_i and t_i. No position in the chain is case-bound.¹⁶ The head C governs and c-commands DP_i and the nominative argument satisfies the K Filter. Informally, the K Filter applies to bare DPs and NPs and requires that no position in an argument chain be case-bound (i.e., is in a small clause, is locally c-commanded, and has a case competitor) and that one position in the argument chain be c-commanded and governed by K (Bittner and Hale 1996: 8).

¹⁵ According to Bittner (1994a), in an ergative language a Nom object (DP) can be *in situ* or be raised to [Spec, I]. For a description of two ways that a Nom argument can satisfy the Case Filter *in situ*, see Bittner (1994a: 14). See also Bittner and Hale (1996, Section 4.2) for an explanation of morphological ergativity due to *transparency*, i.e., nominative objects *in situ* satisfying the K Filter as well as Erg subjects in the VP.

¹⁶ Though the case-chain or an element in the case-chain can act as a case competitor.

A Nom/Abs-Inst/Acc case marked sentence with an AP is illustrated in (26) (see Bittner 1994a: 23, 51-52). The bare DP_i is Nom: there is no case-competitor, and DP_i forms a case chain with t_i and satisfies the K Filter. In Bittner (1994a) as shown in (26a), the trace of the AP, t_j , case-binds the KP object (t_j delimits a KP small clause, locally c-commands a KP argument and the incorporated AP *-si-* is a case competitor) and assigns Inst case by language particular rules of the Case Realization Conventions (see (29)). In Bittner and Hale (1996: 35-40) the AP is an N^0 that is generated adjoined to V and V assigns Inst to the object. Since V case-binds the KP object (delimits a KP small clause, locally c-commands KP, and the AP *-si-* is the pseudo coargument), Inst is assigned by the Case Realization Conventions.

(26) a. Abs/Nom-Inst/Acc Sentences

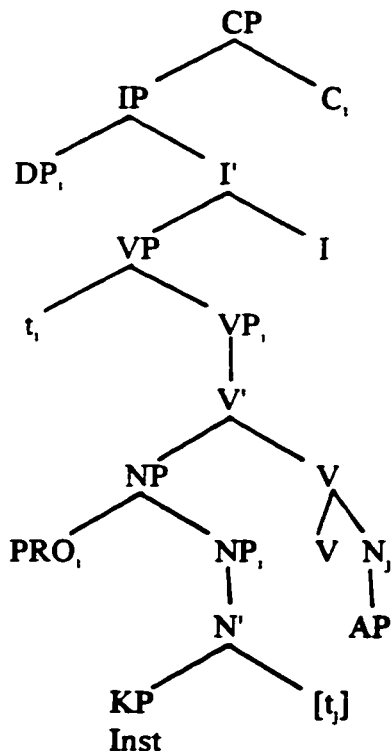

b. Abs/Nom-Inst/Acc Sentences

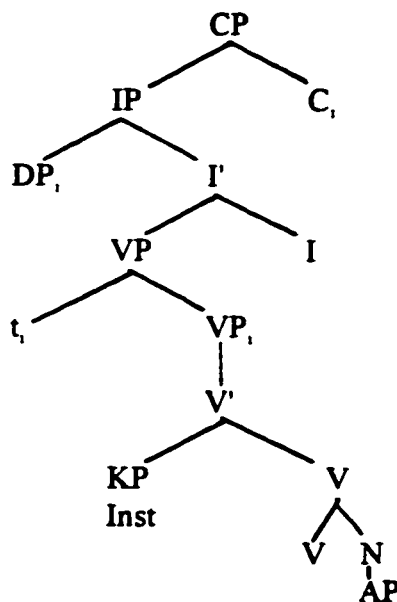

- c. Juuna miiqqa.nik paar.si.vuq (B 1994a: 23)
 Juuna(Nom/Abs) child.(pl)Inst/Acc look-after.AP.IND3A
 'Juuna is looking after the children'

For intransitive verbs as in (27), there is no case competitor so the subject is generated as a bare DP. The DP_i forms a case-chain with t_i; the head C governs and c-commands a node in the case-chain and no node is case-bound.

- (27) a. armaq allar.mat (B 1994a: 18)
 woman(Nom/Abs) leave.CAUS3A
 'when the woman had left, ...'

b. Intransitive Sentence

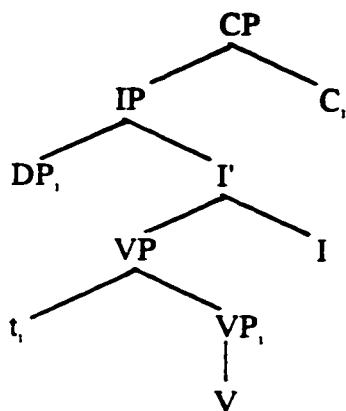

Case assignment is independent of agreement. Agreement is a relation between a functional head and an argument chain that it governs (see Bittner 1994a: 10, Bittner and Hale 1996: 2-3, 17-18): I has Erg (subject) agreement and C has nominative agreement. Agreement can be with the head or the foot of the argument chain. In Inuktitut agreement is with the head of the argument chain. For the intransitive sentence in (27) and the Nom/Abs-Inst/Acc sentence in (26), the functional head C binds DP_i and has nominative agreement, and no ergative agreement is present in I. For the Erg/Gen-Abs/Nom sentence in (25), C binds DP_i and has nominative agreement and I case-binds KP_i and has ergative agreement.

In the possessive construction in (28), D case-binds the subject KP (it delimits an NP small clause, locally c-commands the KP argument subject, and the incorporated N is the case

competitor) and assigns Erg case by the Realization Conventions (see (29)).

- (28) a. Juuna.p qimmi.i (B 1994a: 22)
 Juuna.Erg/Gen dog.pl3POSS
 'Juuna's dogs'

b. Possessive Construction

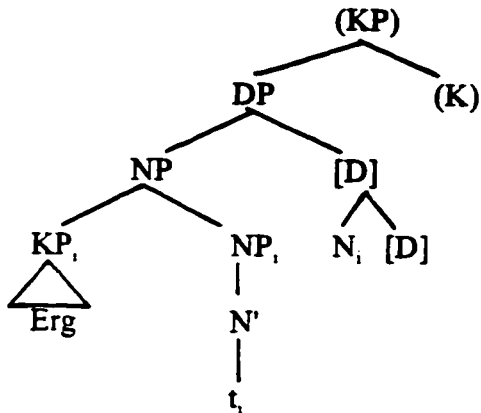

The Conventions for determining the case of an empty K are informally given in (29) (see Bittner (1994a: 8, 17), and Bittner and Hale 1996: 7). The first two are universal and apply to all languages, with it perhaps being parametrized as to whether D as well as I can be a case assigner of Erg (Gen). Case assignment for obliques is language specific and for the languages of the Inuit is in (iii).

(29) Case Realization Conventions

- (i) Erg if the case assigner is I (or D)
- (ii) Acc if the case assigner is $\begin{matrix} & V & \\ & / \quad \backslash & \\ V & & D \end{matrix}$ (or P)

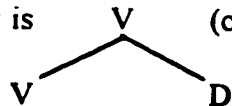

- (iii) Inst (-mik) if KP c-commands a case-binding lexical head
- Dat (-mut) if KP does not c-command the case-binder V
- Abl (-mit) if KP does not c-command the case-binder N

Both (i) and (ii) are called "direct cases" and are assigned by a functional head (I or V+D). If the structural conditions are not met for the direct cases, then the realization conventions in (iii)

apply for the structural oblique cases,¹⁷ with case assigned by a lexical head (V or N) in a case-binding configuration.

Bittner's (1994a) explanation (also Bittner and Hale 1996) for case marking will be criticized on both empirical grounds and on explanatory adequacy. The next chapter looks at the case marking of adnominals, and Section 4.4.4 shows that Bittner's structural explanation would require stipulations to account for the case marking of adnominals as in (30a) where both possessor and thematic arguments have Erg/Gen, and for the case marking of arguments in gerunds as in (30b) where subject has Erg/Gen and theme has Inst/Acc.

- (30) a. tassuma kikia.ngita puuqata.quti.ngat
this-one-here(Gen/Erg) nail.pl3POSSGen/Erg sack.own.3plPOSS(Abs/Nom)
'this one here's sack of nails'
(lit. this one here's nails' sack)
- b. nanu.up qimmir.mik kii.si.ni.nga
polar-bear.Gen/Erg dog.Inst/Acc bite.AP.niq.3POSS(Abs/Nom)
'the bear's biting the dog'

This section argues that the explanation offered in this study for case marking in Inuktitut, and ergative languages in general, is theoretically more desirable than Bittner's explanation. Given two different explanations, even if they had equal empirical adequacy, the more preferred would be the more parsimonious explanation that invokes no new principles nor language specific stipulations. Bittner's explanation is unduly complicated. It distinguishes marked structural case (Erg and Acc), unmarked structural case (Nom), and structural obliques with language specific realization rules. Marked structural case involves a case-binding configuration; and unmarked

¹⁷For a description of the case binding configuration for the structural obliques, see Bittner and Hale (1996) p. 20 for Dat assigned by V, p. 21 for Inst assigned by triadic V, p. 30 for Abs assigned by N to agent in passives.

structural case is constrained by the Case Filter and is not really a case. Case competitors could be coarguments which are maximal projections (DP or NP) that could get case or pseudo coarguments which are incorporated heads (D or N).

Bittner (1994a) points out that the same item might assign structural case in one configuration but not in another. For example, in the sentence in (25) with Erg/Gen-Nom/Abs case marking, I case-binds the subject and assigns Erg case, while in the intransitive sentence in (27), I does not assign case.

She also points out that the same item can assign different structural cases. For example, in (31a) the main V 'think' case-binds the subject of the embedded verb and it assigns Dat case, while in (31b) the V case-binds the 'innermost' internal argument of a three argument verb and assigns Inst case.

(31) a. **Aani.p** miiqqa.t Juuna.mut paari.sur(i-v)ai (B 1994a: 18)
Aani.Erg/Gen child.pl(Nom/Abs) Juuna.Dat look-after.think.IND3E/3A
'Aani thinks that Juuna is looking for the children'

b. Juuna.p miiqqa.t atuakka.mik nassip.pai (B 1994a: 20)
Juuna.Erg/Gen child.pl(Nom/Abs) book.Inst/Acc send.IND3E/3A
'Juuna sent the children a book'

Note that an incorporated head can activate its host head to assign structural oblique case as in the 'antipassive' construction in (26b), or the incorporated head can activate its host head to assign structural direct case as in the possessive construction in (28). The differences are highlighted in (32). Following Bittner (1994a) the case assigner is designated by []. I have marked the case competitor in boldface, and the assigned case that is under discussion is underlined.

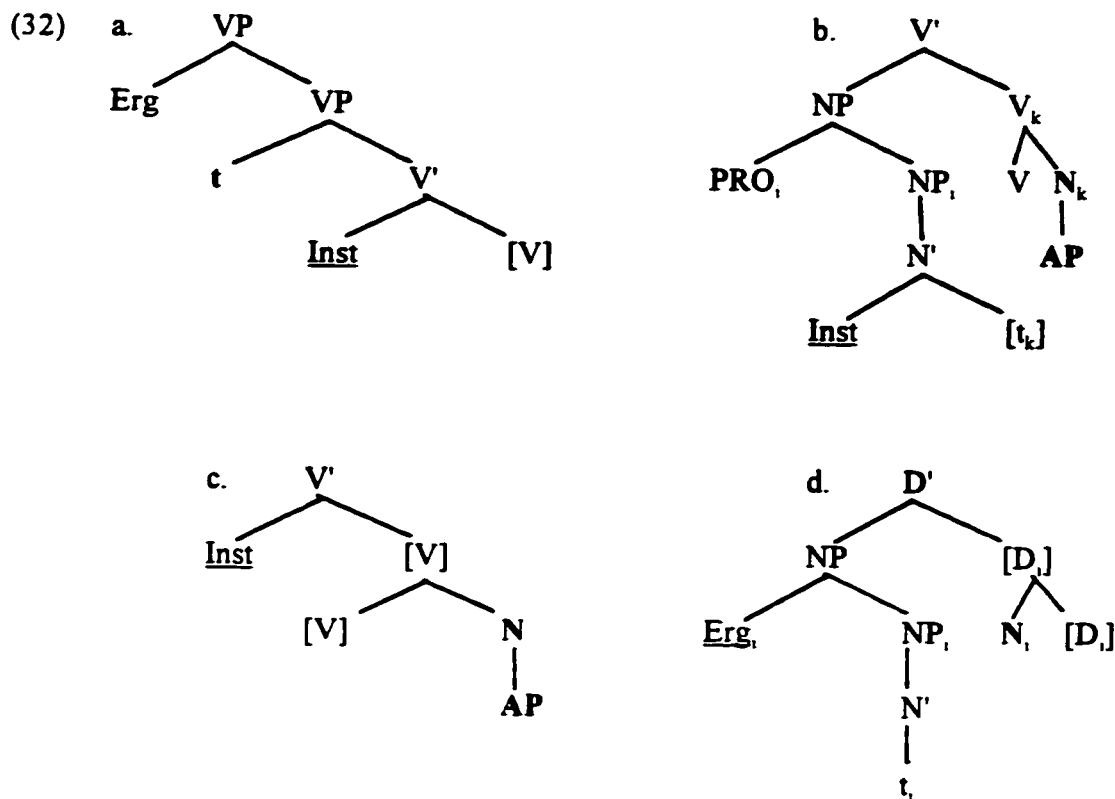

In (32a) a triadic V assigns Inst and the case competitor is the trace of the object that has moved to [Spec, I]; in Bittner (1994a) the trace of an incorporated AP assigns Inst and the case competitor is the AP as in (32b), and in Bittner and Hale (1996) V assigns Inst and the case competitor is the incorporated AP as in (32c); and in (32d) the host head of an incorporated N assigns Erg and the case competitor is the incorporated N.

As the examples in (32) show, case competitors and case assigners seem to be created *ad hoc* to meet a case-binding configuration. As well there are many complex definitions. Importantly Bittner's model only describes a certain structural configuration in which Case Realization Conventions apply, and it does not explain why the cases are manifested as they are in different languages. In contrast, in this study, by using case assignment in a Spec-head

relation (Chomsky 1986a, and checking in Chomsky 1995), my analysis can explain why a particular case marking pattern is used in a language. Thus we reject Bittner's analysis as being less explanatory. Anticipating the discussion in Chapter 4 where it is shown that the case-binding configuration does not account for Gen/Erg marking of adnominals, nor of Gen/Erg-Inst/Acc marking of arguments in gerunds, we will also reject, on empirical grounds, Bittner's explanation for the case marking of ergative versus accusative languages.

3.5 The Dual Case Pattern

This section does not outline a parameter that is posited to explain the existence of ergative versus accusative languages. Rather it presents Bok-Bennema's explanation for what she calls the mixed case systems in the Inuit languages,¹⁸ i.e., the existence of the two case marking patterns Erg/Gen-Abs/Nom and Abs/Nom-Inst/Acc. Which case marking pattern is used depends upon the verb. Some verbs are 'ambiguous' as in (31) and allow either pattern. But most verbs occur in Abs/Nom-Inst/Acc clauses only if there is an AP morpheme and are called "unaccusative transitive" verbs, i.e., they don't assign Acc to the object as in (32).

- (31) a. Hansi.p mattak niri.vaa
Hansi.Erg/Gen mattak(Abs/Nom) eat.IND3E/3A
'Hansi eats mattak'

¹⁸In an earlier work by Bok-Bennema and Groos (1984) there was an ergativity parameter in which "ergativity is always a consequence of the impossibility of Case assignment to a direct object NP by the governor of this NP" (Bok-Bennema 1991: 21). Bok-Bennema (1991) no longer supports such a parameter. Burzio's Generalization (only verbs that can assign a theta role to the subject can assign Acc to an object) figures prominently both in The Unaccusativity Hypothesis for explaining the case marking of the "unaccusative transitive" class of verbs, and throughout her argumentation in which continual reference is made to how the data and analysis relate to Burzio's Generalization.

b. Hansi mattam.mik niri.vuq (BB: p. 247)
Hansi(Abs/Nom) mattak.Inst/Acc eat.IND3A
'Hansi eats mattak'

(32) a. Hansi.p inuit tuqup.paa (BB: p. 259)
Hansi.Erg/Gen people(Abs/Nom) kill.IND3E/3plA
'Hansi killed the people'

b. Hansi inun.nik tuqut.si.vuq (BB: p. 260)
Hansi(Abs/Nom) person.plInst/Acc kill.AP.IND3A
'Hansi killed the people'

First I will describe case assignment in Erg/Gen-Abs/Nom clauses (the (a) examples) and in Abs/Nom-Inst/Acc clauses (the (b) examples). Then I will point out the problems with her analysis.

Bok-Bennema (1991) describes the languages of the Inuit as syntactically accusative but morphologically ergative. Their description as syntactically accusative¹⁹ is based on the behaviour of subject and object arguments. First, the Erg NP subject is PRO in [-finite] clauses, and becomes the oblique in passives as in (33a) and (33b) respectively. Second, object themes can be incorporated as in (33c).

(33) a. anguti.p [PRO qajak atur].uma.vaa (BB: p. 28)
man.Erg/Gen [PRO kayak(Abs/Nom) borrow].want.IND3E/3A
'The man wants to borrow the kayak'

¹⁹Bok-Bennema (1991: 143) describes a syntactically ergative language as one in which the Abs argument is the thematic subject and the Erg argument is the thematic object (but see Chapter 1 where I mentioned that syntactic ergativity refers to S/O patterning alike for grammatical relations such as coordination and relativization). A substantial portion of her book (from Chapters 1 to 4) deals with the impossibility for syntactically ergative languages to exist; argues against the Lexicalist Hypothesis; and argues that the languages of the Inuit are morphologically ergative. In particular she argues against Marantz (1984) who described Central Arctic dialects as syntactically ergative but Greenlandic as morphologically ergative.

b. arnaq (anguti.mit) taku.ta.u.puq (BB: p. 28)
woman(Abs/Nom) (man.ABL) see.PASS.be.IND3A
'The woman is seen (by the man)'

c. Hansi tuttu.si.vuq (BB: p. 28)
Hansi(Abs/Nom) caribou.come-across.IND3A
'Hansi saw a caribou'

Since the language is syntactically accusative,²⁰ the Erg/Gen subject is in [Spec, I]. There is an inherent [+genitive] feature in I²¹ that is associated with transitive clauses which assigns Erg/Gen case to the subject in [Spec, I] through spec-head agreement. The feature [+genitive] is also passed on to the agreement in I.

The diagram in (34b) corresponds to the Erg/Gen-Abs/Nom clause in (34a). The object is adjoined to I' where it gets Nom/Abs case. Since the Erg/Gen subject is in [Spec, I], the object adjoins to I'.

(34) a. piniartu.p nanuq tukut.taa (BB: p. 72)
hunter.Gen/Erg polar-bear(Abs/Nom) kill.IND.3E/3A
'The hunter killed the polar bear'

²⁰Other reasons given for the subject moving to [Spec, I] are the following: the Erg subject binds anaphors so must be in an A position, and since the subject of an intransitive verb moves to get case, then the subject of a transitive verb must also move to get case.

²¹Note that Bok-Bennema generates the external argument as subject of a VP small clause. Finite I selects VPs with a specifier position as stated in (i) *I selects specified VPs* (Bok-Bennema 1991: p. 268).

b. Erg/Gen-Abs/Nom Clauses

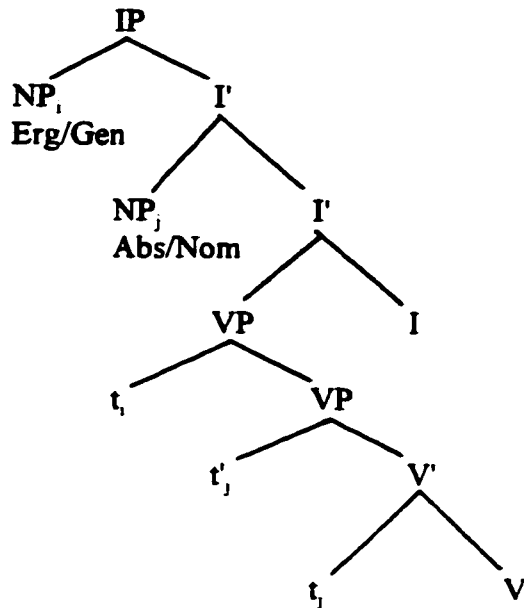

The object obligatorily scrambles to within the IP projection but below the subject for several reasons. First, the canonical word order is given as in (35).

(35) Adv_s Erg Abs Obl Adv_{vp} V (BB: p. 144).

Bok-Bennema says the object couldn't move to [Spec, I], bypassing a subject, as this would violate the Specified Subject Condition (SSC) (Chomsky (1973)). Scope facts as described by Bittner (1987 and in her thesis of 1988) show that Nom/Abs objects have obligatorily scrambled outside the VP taking scope over sentential operators. Since the wide scope reading is also obtained with the conditional mood morpheme *-gu-* 'if', the object must be above the I head (see Bok-Bennema 1991: 215 for the example from Bittner's thesis). Lastly, antecedents for anaphors in the binding theory are in A positions; Erg/Gen subjects serve as antecedents for the reflexives *imminik* and *namminiq* while Abs/Nom objects do not, so Erg/Gen subjects must be in [Spec, I], an A position, and the Abs/Nom object adjoined to I', an A-bar position. This is further

supported by the raising of arguments in complex clauses. In order for arguments in the embedded clause to raise to within the matrix IP as shown in (36) where *mattak*, the embedded object, adjoins to the matrix I', the embedded argument bypasses a PRO subject and the argument *nulia.mi*. This would violate the SSC if the movement were to an A position. However the SSC is not violated because A-bar movement is involved.

- (36) *nulia.mi.nut mattak niri.qqu.aa* (BB: p. 227)
 wife.3ReflPOSS.Abs *mattak*(Abs/Nom) eat.ask.IND3E/3A
 'He asked his wife_i [PRO_i to eat the *mattak*']

The assignment of Gen/Erg by a [+genitive] feature in I to the subject moved to [Spec, I], and of Abs/Nom by a feature [+nominative] in I to the object that has adjoined to I' is the same for the ambiguous verbs such as *niri-* 'to eat' in (31) and the AP taking verbs such as *tuqut(si)-* 'to kill' in (32). However in Abs/Nom-Inst/Acc clauses, although Nom/Abs is assigned in the same way for the two classes of verbs, Inst/Acc is assigned differently.

In clauses with nominative-accusative case marking, a feature [+nominative] in I assigns Abs/Nom case to the argument of an intransitive verb²² which moves to [Spec, I] as in (37). The [+nominative] feature is also passed on to agreement in I.

- (37) a. *Hansi sinip.puq* (BB: p. 260)
Hansi(Abs/Nom) sleep.IND3A
 'Hansi sleeps'

²²Bok-Bennema says unergative verbs do not exist in the languages of the Inuit (1991: 269). Her analysis requires all intransitive verbs to be unaccusative, including verbs like *sana-* 'work', as well as verbs that take clausal complements that are themes as in *uqaq-* 'to say' and *isumaqar-* 'to think'. Because unergative verbs have no direct object, the [Spec, V] position could not be filled with a trace from object movement; so an expletive *pro* is generated in [Spec, V] but there is no NP to link with the expletive leading to ungrammaticality.

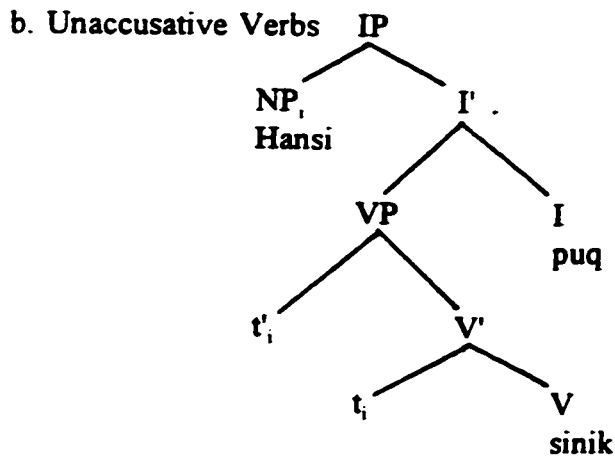

Assignment of Acc case for the ambiguous verbs is illustrated in (38). The feature [+nominative] in I assigns Abs/Nom case to the subject that has moved to [Spec, I]. The [+nominative] feature is also passed on to agreement in I.

- (38) a. Hansi mattam.mik niri.vuq (BB: p. 247)
 Hansi(Abs/Nom) mattak.Inst/Acc eat.IND3A
 'Hansi eats mattak'

b. Abs/Nom-Inst/Acc Clause: Ambiguous Type Verbs

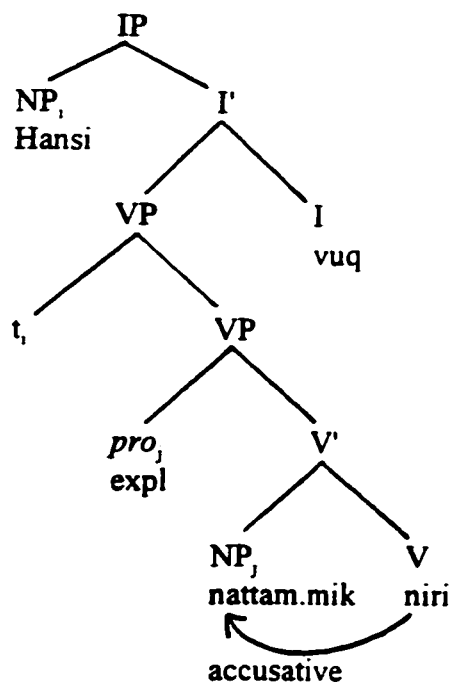

The verb governs the object NP and assigns structural accusative case. Since the [Spec, V] is unfilled by a trace from object movement (on its way to adjoining to I'), an expletive *pro* is generated as the specifier. An interpretive principle at LF associates the thematic object with the expletive. Since an expletive *pro* is existential it must remain inside the VP and the association with the object explains why Inst/Acc objects are indefinite.

When an AP morpheme occurs with the verb for Inst/Acc objects as in (39), structural accusative case is not assigned by the verb, but by the AP morpheme.

- (39) a. piniartuq nannu.mik tuqut.si.vuq (BB: p. 267)
 hunter(Abs/Nom) polar-bear.Inst/Acc kill.AP.IND3A
 'The hunter killed a polar bear'

b. Abs/Nom-Inst/Acc Clause: Unaccusative Transitive Verbs

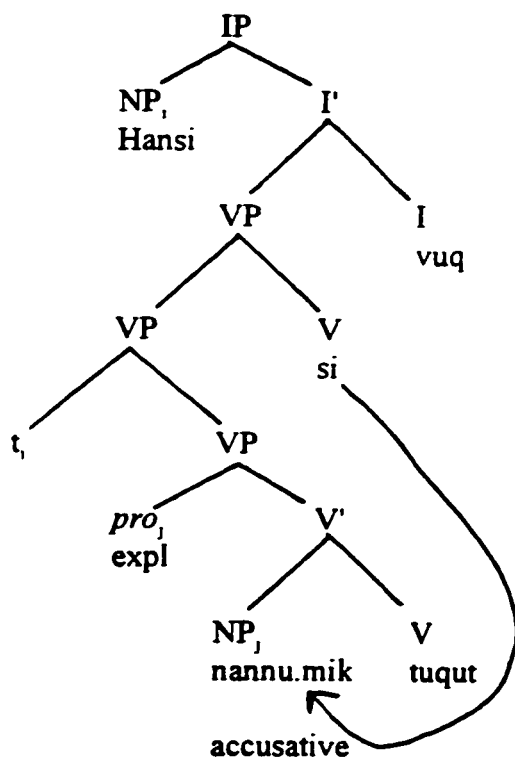

An AP²³ is an X-bar affix that heads its own projection. Anti-passives are like auxiliaries²⁴ and are closely related to affixal noun-incorporating verbs; they assign Acc case to the object of their VP complement. The verb is unable to assign Acc case because it belongs to the group of "unaccusative transitive" verbs, which are characterized by the descriptive generalization (not a parameter) in (40).

(40) The Unaccusativity Hypothesis

In ergative languages verbs never act as structural case assigners.

Because a verb cannot assign case to its object, an ergative language has several options open for assigning case to the object. Inherent case can be assigned to the direct object as in Basque or to the subject as in Georgian. The languages of the Inuit take a different option: either they adjoin the object to I' where it gets Abs/Nom case as in the Erg/Gen-Abs/Nom clause in (34), or they assign Acc/Inst case with an AP morpheme in the Abs/Nom-Inst/Acc clause as in (39). This group of verbs cannot assign Acc because they are like past participles in English in (41) that do not assign Acc to the object. The auxiliary *have* assigns Acc.

(41) a. John has written a letter (BB: p. 273)

b. *John is written a letter

The group of "unaccusative transitive" verbs includes most verbs.²⁵ For the option in (34), I

²³Bok-Bennema (1991: Chapter 6) rejects the traditional view of APs involving argument manipulation whereby the V absorbs the theme role and the object appears as an optional *-mik* oblique, and rejects the incorporation view of Baker (1988).

²⁴For an explanation why APs are like auxiliaries, see Bok-Bennema (1991: 272-278), and for how X-bar affixes can co-govern, see Bok-Bennema (1991: Chapter 3).

²⁵In North Baffin Inuktitut there is one AP morpheme *-si-* and the group of verbs that requires the AP morpheme are verbs of action such as hit, punch, kick, shoot, etc. Kalmar (1979: 142, fn 5) who also studied North Baffin Inuktitut suggests the AP morpheme may exist to

[+transitive] acts like the auxiliary *have* in English, except that instead of assigning Acc it assigns Nom/Abs to the object. For the option in (39), the AP *-si-* of the verb *tuqut(si)-* 'to kill' is the auxiliary and assigns Acc/Inst to the object.

Bok-Bennema's explanation seemingly accounts for two observations: only Erg/Gen and Abs/Nom subjects can bind reflexives while Abs/Nom objects cannot since only the former are in an A position; and there is no violation of the SSC when the object adjoins to I' since the subject is already higher in the tree in [Spec, I]. However, neither of these observations requires Bok-Bennema's analysis to account for them. Alternative explanations for reflexive binding include, for example, Bittner's (1994a) proposal that 'subject paths' formed with the moved subject and its trace act as antecedents for reflexives; binding taking place when arguments are in their thematic positions; and binding conditions holding at LF (Chomsky 1993). To avoid a SSC violation Bok-Bennema had the subject move to [Spec, I], an A position, and the object adjoin to I', an A-bar position. However the SSC refers to the subject of an NP or S and extracting past the subject and out of the NP or S. Since the subject is now considered to be generated within the VP, moving the object past the subject would not violate the SSC since the extraction is out of a VP. Thus Bok-Bennema's analysis is not required to account for anaphoric binding nor for objects moving past subjects.

There are, however, many serious problems with her analysis, including many language specific stipulations; and she herself describes the languages of the Inuit as having an "obviously marked, Case system" (1991: 281). An important source for these problems is that Bok-Bennema makes a false assumption about where the subject moves to. She equates the thematic roles of

prevent a reflexive reading when there is no overt object.

arguments with the position the argument has in syntactic trees; that is, Inuktitut is considered not to be syntactically ergative²⁶ because the thematic subject is generated as the subject of a VP small clause and not as a complement of the verb. In syntactically accusative languages the subject moves to [Spec, I], so subjects of Erg/Gen-Abs/Nom clauses and of Abs/Nom-Inst/Acc clauses must move to [Spec, I]. Some problems that her analysis raises are the following.

- (i) Nom/Abs can be assigned to an A position or to an A-bar position. The mood morpheme I has a [+nominative] feature for assigning Nom/Abs case to the subject in [Spec, I] (A position), or to the adjoined object (A-bar position) if an Erg/Gen subject is in [Spec, I].
- (ii) Having the Erg/Gen subject in [Spec, I] above Abs/Nom object adjoined to I' violates the scope facts described in Bittner (1987). (Recall that Abs/Nom objects have only wide scope while Erg/Gen subjects can have narrow or wide scope.) Bok-Bennema's solution is that since operators are affixal perhaps they do not move and that NPs in A-positions are lowered at LF. These stipulations could account for the two readings for the subjects, but would not account for the wide scope only reading of the Abs/Nom objects.
- (iii) Finite I selecting for VPs with specifiers requires all intransitive verbs, including *pisuk-* 'to walk' and *sinik-* 'to sleep', to be unaccusative since there could be no unergative verbs (see footnote 22). And although generating an expletive *pro* in an unfilled [Spec, V] could account for the 'definiteness effect', it still "remains to be explained why Inuit proper names, pronouns etc. can behave as if they were indefinite [i.e., have Inst/Acc case]" (Bok-Bennema 1991: 268).
- (iv) Bok-Bennema's analysis requires treating complex sentences as "hidden passives", i.e., as

²⁶In a syntactically ergative language the argument in [Spec, I], whether object or subject, patterns alike for relativization, topicalization, etc. (see Bittner and Hale 1996: 26).

passives without overt passive morphology and the subject of the embedded clause as an optional *by*-phrase, because the object of the embedded clause adjoins to the matrix I'. This is illustrated in the Old Labrador example in (42)²⁷ where the embedded object *qerqojat* 'seaweed' moves past the embedded subject *illing* 'you'. This would induce a SSC violation, but since the embedded subject is an oblique, no violation occurs. (42a) is then interpreted as a "hidden passive" on a par with the real passive in (42b), but without overt passive morphology.

(42) a. [qerqojat illing.nut neksar].niarasugiva.vavut (BB: p. 230)
 [seaweed(Abs/Nom) 2sg.All[Dat] take-along].believe.IND1plE/3A
 'We believe that you will take the seaweed with you'

b. qerqojat illing.nut neksar.ta.u.niarasugiva.vavut (BB: p. 230)
 seaweed(Abs/Nom) you.All[Dat] take-along.PASS.be.believe.IND1plE/3A
 'We believe that the seaweed will be taken along by you'

If this were the case, then why would there be both an overt and a hidden passive.

(v) The analysis creates a split between verbs that are ambiguous that can assign Acc and most verbs (unaccusative transitives) that cannot, yet Acc/Inst case on objects in ditransitive verbs as in (43) would still be unexplained. The verb in (43) is *tuni(si)-* which would have to be considered an unaccusative transitive because it takes an AP morpheme; yet there is no AP auxiliary in (43) to have assigned Acc to the object.

(43) Niisi aningaasa.nik tuni.vaa (BB: p. 56 [Fortescue 1984: 89])
 Niisi(Abs/Nom) money.Inst/Acc give.IND3E/3A
 'He gave Niisi money'

Like the parameters described in Sections 3.1, 3.2 and 3.3, and the case-binding configuration for assigning case that were rejected, Bok-Bennema's explanation for the case

²⁷Bok-Bennema cites Woodbury (1985) and Bourquin (1891) who analyze these as "hidden passives".

marking in the Inuit languages must also be rejected for both theoretical and empirical reasons.

Chapter 4

Nominal Phrases

4.1 Introduction

This section looks at the case marking in nominals in Inuktitut and shows that the case marking of adnominals is as expected if, as argued for in Chapters 1 and 2, Abs/Nom is assigned¹ by I, Erg/Gen is assigned by V, and Inst/Acc is assigned to the complement of V by insertion of the postposition *-mik*. If Abs/Nom is associated with I, it is expected that there would not be an Abs/Nom case marked argument of a noun. This is precisely what is observed. Whether the head is a N, deverbal nominal or a gerundive nominal, there is no Abs/Nom case marked argument within an NP.² Gen (=Erg) is assigned by N to arguments in [Spec, N] and, in gerunds, by V to arguments in [Spec, V]. Also as expected, Acc (=Inst) can not be assigned to adnominal complements but can be assigned to complements in gerunds by V. The case marking patterns in nominals in Inuktitut will be illustrated in the next two sections. Section 4.2 looks at the case marking pattern in nominals with N and deverbal N heads. Section 4.3 looks at the case marking pattern in gerundive nominals. Section 4.4 returns to the parametric accounts presented in Chapter 3. Section 4.5 is a brief summary.

¹According to the Minimalist Program, features are checked, rather than assigned. I explained in Chapter 1, Section 1.4 why I describe the structural cases as "assigned" rather than "checked". Thus I use the term assigned. My analysis would not be affected if certain features such as case were checked rather than assigned.

²But see Section 4.2.2 on theme arguments in apposition to deverbal nominal heads.

4.2 Nouns and Deverbal Nominals

4.2.1 Underived Nominals

As noted in Chapter 1, English allows only one Gen 's case marked argument of a noun. This is shown in (1a) and (1b) where the possessor has Gen case 's and the other argument has *of* insertion. Like other languages, nouns in English do not assign Acc case as shown in (1c) versus (1d) for verbs.

- (1) a. John's book of mammals
b. *John's mammals' book
c. *John's book mammals
d. John studies mammals

Some examples of possessed nouns in Inuktitut are in (2).

- (2) a. talir.ma ami.nga (S1: p. 72)
arm.1POSSErg/Gen skin.3POSS(Abs/Nom)
'the skin of my arm'

b. tuktu.up nagju.ngata nuvu.a (S1: p. 72)
caribou.Erg/Gen horn.3POSSErg/Gen tip.3POSS(Abs/Nom)
'the tip of the caribou's horn'

Inuktitut allows possessor or agent and theme adnominals of non-derived NPs to both be expressed in Gen/Erg as shown in (3a). Like other languages, the theme adnominal cannot have objective case Inst/Acc as shown in (3b), and in Inuktitut the theme is also marked with Gen/Erg.

- (3) a. taami.up kikia.ngita puuqata.quti.ngat
Tommy.Gen/Erg nail.pl3POSSGen/Erg sack.own.3plPOSS(Abs/Nom)
'Tommy's sack of nails'
(lit. 'Tommy's nails' sack')

b. *taami.up kikia.nik puuqata.quti.nga
Tommy.Gen/Erg nail.plInst/Acc sack.own.3POSS(Abs/Nom)
'Tommy's sack of nails'

If there is only one Gen/Erg adnominal the affix *-quti-* 'own' can be used to disambiguate

between a possessor reading as in (4a) from a complement argument as in (4b).

(4) a. anguti.it nipi.quti.ngit
man.plGen/Erg tape.own.pl/3plPOSS(Abs/Nom)
'the men's (P) tapes' (belonging to the men)
*'the men's (T) tapes' (tapes of men's voices)

b. anguti.it nipi.ngit
man.plGen/Erg tape.pl/3plPOSS(Abs/Nom)
*'the men's (P) tapes'
'the men's (T) tapes' (tapes of men's voices)

The case marking on the head N is determined by the structural position of the NP in the sentence. Thus in (5) the NP subject of the intransitive V has Abs/Nom case; in the specific example in (6) the object of the transitive V has Abs/Nom case; and in the non-specific example in (7) the object of the transitive V has Inst/Acc case.

(5) tassuma kikia.ngita puuqata.quti.ngat uqi.nngit.tuq
this-one-here(Erg/Gen)nail.pl/3POSSGen/Ergsack.own.3plPOSS(Abs/Nom)be-light.not.IND3A
'this one here's sack of nails is not light'

(6) tassuma kikia.ngita puuqata.quti.ngat qima.lauq.tara
this-one-here(Erg/Gen) nail.pl/3POSSGen/Erg sack.own.3plPOSS(Abs/Nom)
leave-behind.PAST.IND1E/3A
'I left behind this one here's sack of nails'

(7) ama.up uqalimaa.ngata nipi.quti.nga.ngik naala.lauq.tunga
woman.Erg/Gen story.3POSSerg/Gen tape.own.3POSS.Inst/Acc listen.PAST.IND1A
'I listened to the woman's tape of the story'

Although the case marking on the NP varies according to its structural position in the sentence, the examples in (5), (6) and (7) show the Erg/Gen case marking on the adnominals is invariant.

4.2.2 Deverbal Nominals

As with the nominals in 4.2.1, both the possessor or agent and theme adnominals of deverbal nominals are case marked with Erg/Gen as in (8a), and the theme cannot be marked with Inst/Acc as in (8b).

(8) a. *pili.up qilliqtu.ngata [sana.ja].nga uqi.nngit.tuq*
 Billy.Erg/Gen brilliant.3POSSErg/Gen [make.thing].3POSS(Abs/Nom) be-light.NEG.IND3A
 'Billy's brilliant handicraft is heavy'

b. **pili.up qilliqtu.mik [sana.ja].nga uqi.nngit.tuq*

And again as with the nominals in 4.2.1, the structural position in the sentence affects only the case marking on the head N and not on the adnominals. Thus in the intransitive sentence in (8a), the deverbal nominal head *sana.jaq* has Abs/Nom case. The object of the transitive V in a specific sentence has Abs/Nom case as in (9a), while in a non-specific sentence it has Inst/Acc case as in (10).

(9) a. *simiuni.up ujara.ngata [sana.ja].nga taku.jara*
 Simeonie.Erg/Gen stone.3POSSErg/Gen [make.thing].3POSS(Abs/Nom) see.IND1E/3A
 'I saw Simeonie's handicraft of stone'

b. **simiuni.up ujarar.mik [sana.ja].nga taku.jara*

(10) *simiuni.up ujara.ngata [sana.ja].nga.nik taku.junga*
 Simeonie.Erg/Gen stone.3POSSErg/Gen [make.thing].3POSS.Inst/Acc see.IND1A
 'I saw Simeonie's handicraft of stone'

It may appear that theme arguments can have Abs/Nom case as in (11), however these are Ns in apposition to the head N.³

(11) *pili.up qilliqtuq [sana.ja].nga uqi.nngit.tuq*
 Billy.Erg/Gen brilliant(Abs/Nom) [make.thing].3POSS(Abs/Nom) be-light.NEG.IND3A
 'Billy's brilliant handicraft is heavy'

³This study does not discuss what the difference in meaning is between sentences like (10), repeated here as (i), that have Erg/Gen case marking on the theme and sentences that have the theme in apposition as in (ii). The sentences have the same general meaning and the wood is still Simeonie's, but a native speaker described (i) as *it's Simeonie's, it's his wood* and (ii) as *it's still Simeonie's wood and the wood is around somewhere*.

i. *simiuni.up qijuarju.ngata sana.ja.nga uqit.tuq*

ii. *simiuni.up qijuarjuq sana.ja.nga uqit.tuq*

'Simeonie's handicraft of wood is light'

In Inuktitut only deverbal nominals allow theme arguments to be in apposition, underived nominals and gerunds do not as shown in (12a) and (12b) respectively.

- (12) a. *pili.up niqi puuqata.quti.nga uqi.nngit.tuq
 Billy.Erg/Gen food(Abs/Nom) sack.own.3POSS(Abs/Nom) be-light.NEG.IND3A
 'Billy's bag of food is heavy'
- b. *nanuq saglu.ni.nga
 polar-bear(Abs/Nom) lie.niq.3POSS(Abs/Nom)
 'his lying about the polar bear'

Furthermore the N in apposition has the same case marking as the head N. Thus in (11) the possessed head N *sanajaq* has Abs/Nom and the theme adnominal *qilliqtuq* also has Abs/Nom. And in (13b), *sanajaq* the object of the verb in the non-specific sentence has Inst/Acc case and *ujaraq* the N in apposition also has Inst/Acc case.

- (13) a. simiuni.up ujara.ngata [sana.ja].nga.nik taku.junga
 Simeonie.Erg/Gen stone.3POSSErg/Gen [make.thing].3POSS.Inst/Acc see.IND1A
 'I saw Simeonie's handicraft made of stone'
- b. simiuni.up ujarar.mik [sana.ja].nga.nik taku.junga
 c. *simiuni.up ujarraq [sana.ja].nga.nik taku.junga

If the head N has Inst/Acc, the theme in apposition cannot have Abs/Nom as shown in (13c). And, as shown in (8b) and (14), Inst/Acc is not assigned to the theme by the deverbal nominal since the theme cannot be marked Inst/Acc unless the head N is also.

- (14) *simiuni.up ujarar.mik [sana.ja].nga taku.jara
 Simeonie.Erg/Gen stone.Inst/Acc [make.thing].3POSS(Abs/Nom) see.IND1E/3A
 'I saw Simeonie's handicraft made of stone'

4.2.3 Summary

A nominal head assigns Gen/Erg case both to its possessor/subject argument and to its theme argument. The nominal head assigns neither Inst/Acc case nor Abs/Nom case, which are assigned by V and I respectively.

Japanese also allows both adnominals to have Gen case as shown in (15).

- (15) Mary-no nihon-de-no suugaku-no benkyoo (Mi eg. (6))
Mary-Gen Japan-in-Gen math-Gen studying
'Mary's studying of math in Japan'

In Japanese, checking of Gen is at LF and Miyagawa (1993: 219) "presume[s] that one genitive phrase moves into the Spec, and the other adjoins to the DP, in essence counting as a second Spec position." It was also noted in Section 1.4 that the checking domain of a head includes its specifier and "a position adjoined to the specifier of [the head]" (Marantz 1995: 365). Further evidence that the Gen does not move until LF is noted with the *ga/no* conversion in Japanese where a Gen object could not scramble past a Gen subject (an Acc object could scramble past a Nom subject) (Miyagawa 1993: 246).

4.3 Gerundive Nominals

Gerundives in English, as noted in Chapter 1, have Gen case marked subjects and Acc case marked objects as in (16).

- (16) [*John's reading the book*] disturbed me (C 1986a)

In Inuktitut, gerundives formed with the nominalizer *-niq* also have Gen/Erg subjects and Inst/Acc objects. The examples in (17a) and (17b) show that an overt agent (Ag) subject has Gen/Erg case. In (17a) the subject is *angak* with Gen/Erg case *-up*, and in (17b) the subject is *qimmiq* with the Gen/Erg case marker *-up*. Example (17) also shows that the verb has the non-specific morphology.

- (17) a. anga.up kati.si.ni.nga
maternal-uncle.Gen/Erg meet.AP.niq.3POSS(Abs/Nom)
'maternal uncle's (Ag) meeting'
*'maternal uncle's (P) meeting'

b. qimmi.up kii.si.ni.nga
dog.Gen/Erg bite.AP.niq.3POSS(Abs/Nom)
'the dog's (Ag) biting'
*'the dog's (P) biting'

c. pisung.ni.nga
walk.niq.3POSS(Abs/Nom)
'his walking'

d. saglu.ni.ra
lie.niq.1POSS(Abs/Nom)
'my lying'

The specific form of the verb cannot be used as shown in (18a) and (18b), which contrast with (17a) and (17b).

(18) a. *anga.up kati.ni.nga
maternal-uncle.Gen/Erg meet.niq.3POSS(Abs/Nom)

b. *qimmi.up kii.ni.nga
dog.Gen/Erg bite.niq.3POSS(Abs/Nom)

The theme (P) has Inst/Acc case as shown in (19). The object theme cannot have Gen/Erg as shown by the contrast in (20) and (21) in which the ungrammatical (a) examples have theme arguments marked with Gen/Erg while the grammatical (b) examples have theme arguments marked with Inst/Acc. The theme in (20) is a noun while in (21) it is a gerundive nominal.

(19) nanu.up qimmir.mik kii.si.ni.nga
polar-bear.Gen/Erg dog.Inst/Acc bite.AP.niq.3POSS(Abs/Nom)
'the bear's biting the dog'

(20) a. *unikkaaqtua.p tukisi.ni.nga
legend.Gen/Erg understand.niq.3POSS(Abs/Nom)

b. unikkaaqtuar.mik tukisi.ni.nga
legend.Inst/Acc understand.niq.3POSS(Abs/Nom)
'understanding the legend'

- (21) a. *maulir.ni.up singnaktuuma.ni.nga
 hunt-at-seal-breathing-holes-in-winter.niq.Gen/Erg dream.niq.3POSS(Abs/Nom)
- b. maulir.nir.mik singnaktuuma.ni.nga
 hunt-at-seal-breathing-holes-in-winter.niq.Inst/Acc dream.niq.3POSS(Abs/Nom)
 'dreaming of hunting at seal breathing holes in winter'

The theme also cannot be in apposition as shown in (22).

- (22) a. *angak kati.si.ni.nga
 maternal-uncle(Abs/Nom) meet.AP.niq.3POSS(Abs/Nom)
- b. *qimmiq kii.si.ni.nga
 dog(Abs/Nom) bite.AP.niq.3POSS(Abs/Nom)

The theme, however, can have Gen/Erg case if it becomes the structural subject of the verb when the verb passivizes as in the examples in (23).

- (23) a. anga.up kati.jau.ni.nga
 maternal-uncle meet.PASS.niq.3POSS(Abs/Nom)
 *'maternal uncle's (Ag) meeting'
 'maternal uncle's (P) meeting'
- b. qimmi.up kii.jau.ni.nga
 dog.Gen/Erg bite.PASS.niq.3POSS(Abs/Nom)
 *'the dog's (Ag) biting'
 'the dog's (P) biting'

As with the nouns and derived nominals, the case marking on the gerund is determined by its structural position in the sentence and the arguments within the gerund are not affected by the structural position of the gerund. In (24a) the gerund is the Abs/Nom case marked subject of the intransitive verb; in (24b) the gerund is the Abs/Nom case marked specific object of the transitive verb; and in (24c) the gerund is the Inst/Acc case marked non-specific object of the transitive verb. In all cases the case marking on the arguments within the gerund are not affected by the case marking on the gerund.

- (24) a. [kiinaujar.nik piusang.ni.nga] angi.juq
 [money.plInst/Acc like.niq.3POSS(Abs/Nom)] be-big.IND3A
 'his love of money is big'
- b. [nanu.up qimmir.mik kii.si.ni.nga] ugguri.jaa
 [polar-bear.Gen/Erg dog.Inst/Acc bite.AP.niq.3POSS(Abs/Nom)] regret(serious).IND3E/3A
 'he regrets the bear biting the dog'
- c. [maali.up nanur.mik saglu.ni.nga.nik] aittaarusuk.tunga
 [Molly.Gen/Erg polar-bear.Inst/Acc lie.niq.3POSS.Inst/Acc] regret(too bad).IND1A
 'I regret Molly lying about the bear'

The case marking of arguments and the morphological form of the verb in gerunds is entirely as expected. First, since Gen/Erg is checked by V, then an argument in [Spec, V] will have Gen/Erg. Since the gerund is a nominal there is no IP and the object argument cannot move to [Spec, I] for Abs/Nom case, and must remain inside the VP where it is assigned Inst/Acc case by V through *-mik* case insertion. The object argument having Inst/Acc case means the V has non-specific morphology. If the V is passivized, then the object argument moves to [Spec, V] becoming the subject with Gen/Erg case which is checked by the V.

4.4 Parametric Explanations

Chapter 3 discussed five parametric explanations for ergative case marking in Inuktitut. On the grounds of empirical adequacy for clauses and/or theoretical adequacy, these explanations were rejected. This section briefly considers how well those explanations can account for the case marking of arguments in nominal phrases.

4.4.1 Lexical Properties Parameter

According to the lexical properties parameter of Johns (1987, 1992) (see Section 3.1), for clauses in Inuktitut (i) there are only two functional projections: nominal level AgrP_N (=NP) and

predicate level AgrP_V (=IP), and (ii) the subject and object arguments are generated in the [Spec, Agr_N] and [Spec, Agr_V] respectively. The complement of Agr_V is AgrP_N and the complement of Agr_N is a nominalized V. The N head of the complement moves, through head movement, to Agr_N then to Agr_V, getting agreement.

For NPs there is just the AgrP_N projection as in (25). The subject/possessor is generated in [Spec, Agr_N] and the N head is generated as the complement of Agr_N. Agr_N has agreement features for the NP in its Spec. The N head gets the agreement features through head movement to Agr_N.

(25) a.

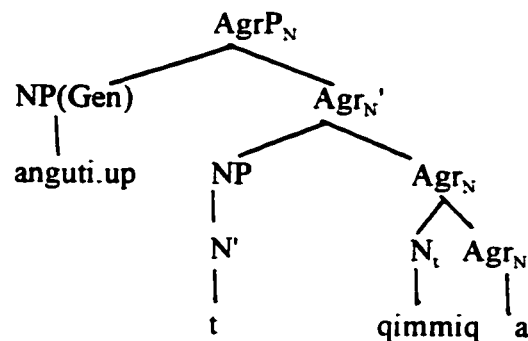

b. anguti.up qimmi.a (J 1992: 69)
 man.Gen/Erg dog.3POSS(Abs/Nom)
 'the man's dog'

Johns analysis, however, cannot explain the case marking on arguments of Ns, deverbal nominals and gerunds. Recall from Section 4.2 that subject and object adnominals of nouns and derived nominals have Gen/Erg case. Example (3a) is repeated here as (26).

(26) taami.up kikia.ngita puuqata.quti.ngat
 Tommy.Gen/Erg nail.pl/3POSSGen/Erg sack.own.3plPOSS(Abs/Nom)
 'Tommy's sack of nails'

In Johns model, if arguments are generated in [Spec, Agr], the subject *taami* would be in [Spec, Agr_N] and the N head *puuqata.quti* would be generated as the complement of Agr_N. The object

kikia.t could not be generated in a [Spec, Agr] since there is no Agr_v.

Accounting for the arguments in gerunds is also problematic. Recall from Section 4.3 that agent subject arguments have Gen/Erg case and theme object arguments have Inst/Acc case as shown in (19), repeated here as (27).

(27) *nanu.up qimmir.mik kii.si.ni.nga*
polar-bear.Gen/Erg dog.Inst/Acc bite.AP.niq.3POSS(Abs/Nom)
'the bear's biting the dog'

If arguments are generated in [Spec, Agr], then there is no position for the theme argument *qimmig* to be generated. Her model would also need to distinguish between the case marking of arguments of nouns and derived nominals versus gerundive nominals.

4.4.2 Obligatory Case Parameter

According to this parameter (see Section 3.2), Bobaljik (1993) associates Erg with Nom case and Abs with Acc case. There are two AgrP functional projections and Erg/Nom case is associated with the higher AgrP while Abs/Acc is associated with the lower AgrP. The difference between nominative languages and ergative languages, as given in (28), is that for the former the obligatory case is Nom while for the latter the obligatory case is Abs.

(28) Obligatory Case Parameter

Case X is obligatorily assigned/checked, where Case X is a structural case.

a. In N/A languages, CASE X is NOMINATIVE (=ERG)

b. In E/A languages, CASE X is ABSOLUTIVE (=ACC)

The Obligatory Case Parameter as stated (Bobaljik 1993: 51) is unable to explain the case marking in nominals. Since Gen=Erg in Inuktitut, then for nominals only the higher AgrP would be operative. However since Inuktitut is ergative this violates the parameter which states that if Case X=NOM=ERG is operative, the language is nominative.

A solution would be to state that the parameter applies to clauses and is not relevant for nominal phrases. However the parameter associates the lower AgrP with Abs and thus makes the wrong prediction for the case marking in gerunds. It predicts that for ergative languages Abs case as the Agr node above VP should be available for the theme argument. But as noted in Section 4.3, there is no Abs argument in nominal phrases and the theme argument in gerunds has Inst/Acc case.

4.4.3 Transitivity Parameter

The transitivity parameter (see Section 3.3) as stated in Murasugi (1992a: 221) ascribes the difference between nominative and ergative languages to a difference in strength between the two functional projections of clauses as given in (29).

(29) Transitivity Parameter

In an accusative language, the Case features of T [tense] are strong.
In an ergative language, the Case features of Tr [transitive] are strong.

Thus this parameter is not applicable for explaining the case marking of adnominals.

It is expected that the model would be able to explain the case marking of theme arguments in gerunds since the case marking is expected to be related to the case marking of theme arguments of verbs. However, as noted in Section 3.3, this model could not explain the Abs/Nom-Inst/Acc case marking in non-specific clauses, and is thus unable to explain the Inst/Acc case marking of theme arguments in gerunds.

4.4.4 Case-Binding Configuration

Recall that in Bittner (1994a; Bittner and Hale 1996) functional heads (I or D and V+D) assign the "direct" structural cases ergative and accusative, while lexical heads assign the oblique structural cases according to language specific conventions.

I and D assign Erg to a KP with an empty K in a case binding configuration (i.e., I/D delimits a small clause and c-commands the KP, and there is a case competitor which is a coargument NP/DP that could potentially get case from I/D or a pseudo coargument D/N). The oblique case Inst is assigned to a KP complement by a lexical head also in a case-binding configuration. For example, V, the lexical head of a triadic verb, assigns Inst to its complement and the case competitor is the trace of the internal argument DP that has moved to [Spec, I] (Bittner 1994a: 20). Nominative arguments are generated as bare DPs without a KP projection in which the DP is governed and c-commanded by K or C and neither DP nor its trace is case-bound.

In Chapter 3 Bittner's explanation for case marking was rejected on explanatory grounds, and now I will provide empirical evidence for rejecting Bittner's explanation that functional heads assign Erg/Gen in a case-binding configuration. In Section 3.4 it was mentioned that empirical evidence for rejecting Bittner's analysis is based on case assignment of adnominals as in (30a) and in gerunds as in (30b).

- (30) a. tassuma kikia.ngita puuqata.quti.ngat
 this-one-here(Gen/Erg) nail.pl3POSSGen/Erg sack.own.3plPOSS(Abs/Nom)
 'this one here's sack of nails'
 (lit. this one here's nails' sack)
- b. nanu.up qimmir.mik kii.si.ni.nga
 polar-bear.Gen/Erg dog.Inst/Acc bite.AP.niq.3POSS(Abs/Nom)
 'the bear's biting the dog'

First I show that the case-configuration approach cannot explain Gen/Erg on the possessor and theme arguments of a nominal as in (30a), then I show that her approach cannot explain the Erg/Gen-Inst/Acc case marking in gerunds without adding stipulations.

In many languages, including the languages of the Inuit, Erg and Gen have the same case

marking and the same agreement (Dixon 1994, Bittner and Hale 1996). Thus Erg is assigned by I in clauses in a case-binding configuration and it is parametrized that Erg (=Gen) is assigned by D in nominals in a case-binding configuration. This is illustrated in example (31) from Bittner and Hale (1996: 60) (see also Bittner 1994a: 22). Following Bittner I have put [] around the case assigning head; and, for ease of understanding, I have underlined the case under discussion and put the case competitor in boldface.

(31) a. Possessive Construction

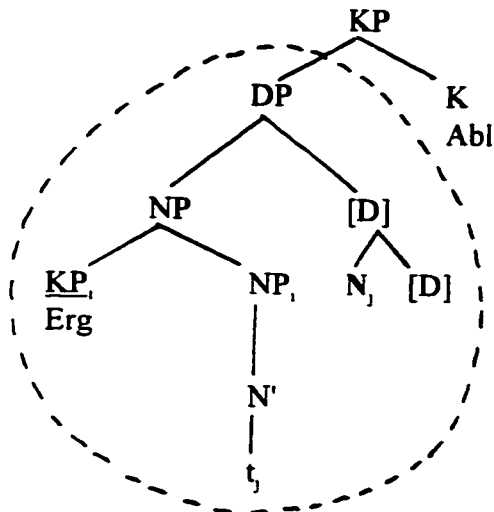

b. juuna.p qimmi.i.nit (B 1996: 60)
 Juuna.Erg/Gen dog.pl3POSS.Abl
 'from Juuna's dogs'

D is a functional head that delimits an NP small clause (delimited from below by (the trace of) N and from above by D), N incorporates into D so NP is not a barrier to D c-commanding KP and assigning KP case, and the incorporated N is a case competitor (pseudo coargument) for KP. Thus the case binding configuration is met and D assigns Erg to KP according to the universal rules for assignment of marked structural (direct) case. D has Erg agreement for the Erg case marked possessor.

Now let's look at the tree diagram for (30a) where both the possessor and theme have Erg/Gen case. Neither Bittner (1994a) nor Bittner and Hale (1996) provided examples like (30a), so I extend their analysis to (31).

(32) Possessive Constructions with Theme Arguments

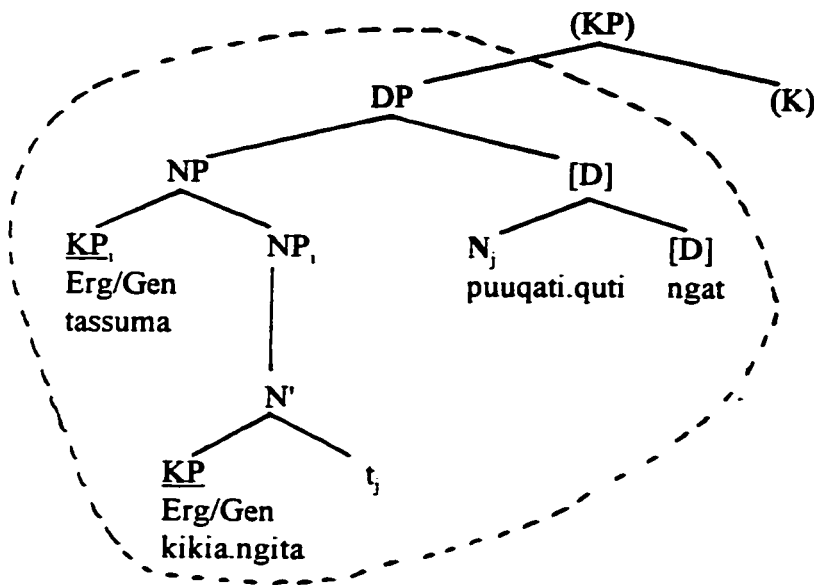

Comparing the constructions in (31) and (32) it would seem that D could assign Erg/Gen to both KP *tassuma* and KP *kikiat* since both are in the same domain and meet the case-binding requirements and N could be the pseudo coargument for both. However Erg agreement on D is only with the KP complement *kikiat* and the latter has agreement with the KP subject *tassuma*. Thus, although one functional head D would assign two Erg cases in the same case-binding configuration, agreement would not be between a functional head and the argument chain that it governs.

Comparing the case-binding configuration in (32), that allows one functional head to assign two Erg cases to similar constructions for clauses, highlights the ad hoc stipulation about generating caseless DPs. In the similar clause constructions, the complement was not a KP but

was generated as a DP because otherwise there would be no case competitor. Examples in (33) are illustrated in (34). Example (34a) represents languages such as Samoan and Warlpiri that have 'morphological ergativity' due to transparency⁴ (Bittner and Hale 1996: Section 4.2). Example (34b) represents the structure of *-niqar-* passives (Bittner and Hale 1996: Section 6).

- (33) a. sa sasa e le teine le maile (Samoan, B&H: p. 21)
 PAST hit Erg the girl the dog
 'The girl hit the dog'
- b. puisit (Juuna.mit) aallaa.ni.qar.put (West Greenlandic, B&H: p. 29)
 seals(Abs/Nom) (Juuna.Abl) shoot.PASS.be.IND3pl
 'The seals were shot (by Juuna)'

(34) a. Ergativity due to Transparency

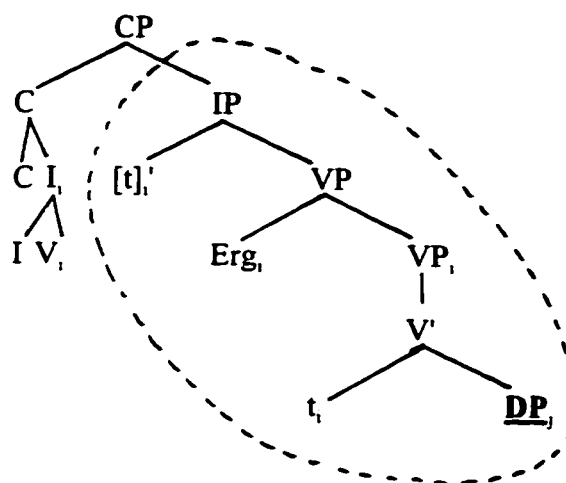

b. Passives

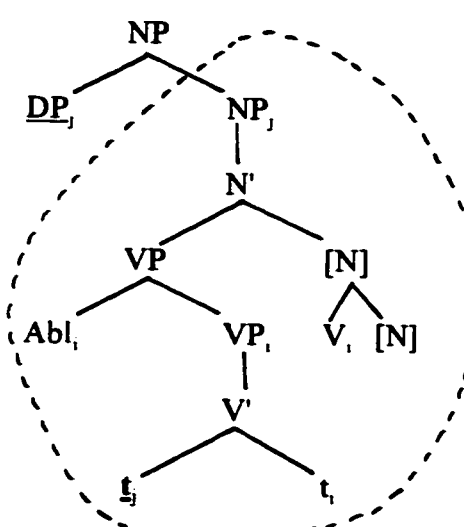

The functional head D can case-bind both possessor subject and thematic object in (32) and assign Erg. However the trace of the functional head I in (34a) cannot case-bind the complement as well as the subject and assign Erg to both since there is no caseless case-competitor. So the complement is generated as a DP instead of a KP. Similarly in (33b), the

⁴It also represents Ergative Active Languages such as Basque with only the I incorporating into C (Bittner and Hale 1996: Section 5).

passive N cannot assign structural oblique cases to the subject and object of V since there is no caseless case-competitor. Thus the complement is generated as a DP rather than as a KP. Thus, Bittner's analysis requires that a potential nominative argument look ahead in the derivation to see if it is needed to be a case competitor in order to provide a case-binding configuration for other arguments to get case. Because of these ad hoc stipulations, the case-binding configuration must be rejected.

The analysis of case marking in gerunds provides further reason for rejecting Bittner's analysis. Bittner's description of gerunds (1994a: 64-66) combined deverbal nominals with a *-niq* head and gerunds formed with *-niq*. First I will separate *-niq* deverbal nominals from *-niq* gerunds, then I will show the problems with the case-binding configuration in accounting for the case marking of arguments in gerunds as in (30b).

Bittner describes the N head *-niq* as moving to the D head, and the DP argument as moving to [Spec, N] as in (35) and illustrated in (36).

(35) a. [qimmi.vit unatar.nir.at] piqqissimissutig(i-v)a.ra (B 1994a: 64)
 [dog.pl2POSSGen/Erg beat.niq.3plPOSS(Abs/Nom)] *pro*(1sg) regret.IND1E/3A
 'I regret beating your dogs'

b. [qimmi.t qilun.nir.at] Kaali.p tusa.nngi.la.a (B 1994a: 64)
 [dog.plGen/Erg bark.niq.3plPOSS(Abs/Nom)] Kaali.Erg/Gen hear.NEG.IND3E/3A
 'Kaali didn't hear the dogs' barking'

The KP argument that has moved to [Spec, N] is case bound by D in a case-binding configuration (D delimits the small clause NP, and c-commands the KP argument (NP is not a barrier since N has incorporated into D), the case competitor is *-niq* which has adjoined to D). In the (a) examples the object argument has moved to [Spec, N] getting Gen/Erg, while in the (b) examples the subject argument has moved getting Gen/Erg.

(36) a.

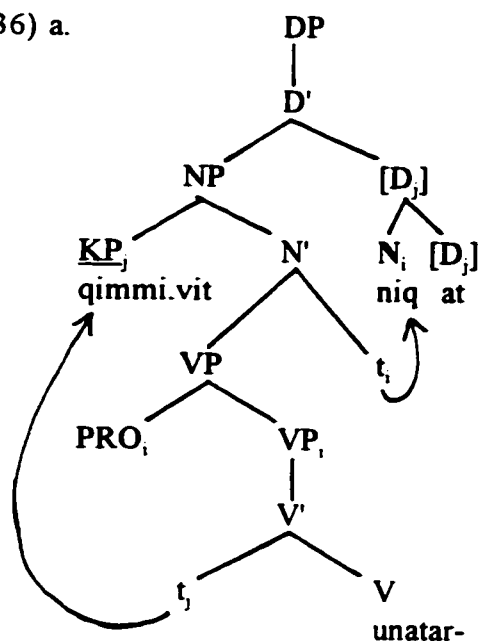

b.

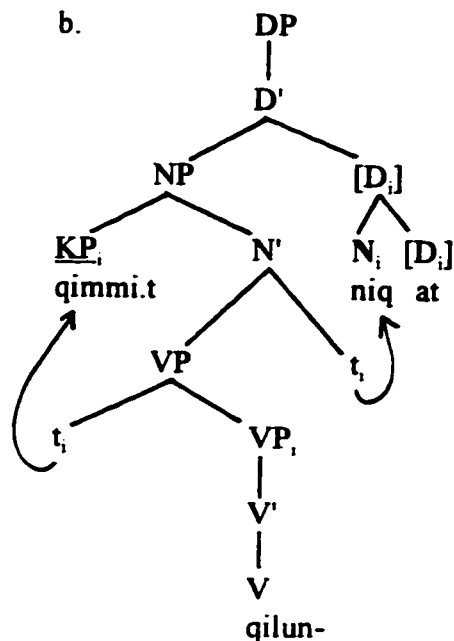

In the Inuktitut gerunds (see Section 4.3), theme arguments couldn't get Gen/Erg case unless the V was passivized. However in non-derived and deverbal nominals both arguments could get Gen/Erg case. I suggest that (35a) involves a *-niq* deverbal nominal, while (35b) involves a *-niq* gerund.⁵ This parallels the difference in English between *-ing* deverbal nominals where both subject and objects adnominals can be marked with Gen as in (37a), and gerunds where the subject has Gen and the object Acc as in (37b).

(37) a. The Bank of Canada's setting of the interest rate each week has been discontinued

b. Treasury Board's fixing the amount of the tax cut is still speculative

This is supported by examples of *-niq* nominals in West Greenlandic (Fortescue 1984) which suggest that WG is like Inuktitut for gerunds, i.e., the agent has Gen/Erg case, V is a "half-transitive phrase" (i.e., non-specific form), and the theme has Inst/Acc case. This is shown

⁵The example in (35b) could also be a *-niq* deverbal nominal, but (35a) could not be a gerund.

in (38a) where the overt NP is an object and has Inst/Acc case (the subject is *pro*), and in (38b) where the overt NP is a subject and has Erg/Gen case. In both cases V has the non-specific form.

(38) a. [aja.mi.nik naapit.si.ni.ssa.a] qilanaar.aa (F 1984: 46)
 [maternal-aunt.3ReflPOSS.Inst/Acc meet.AP.niq.FUT.3POSS(Abs/Nom)] look-forward-to.IND3E/3A
 'he_i looked forward to his_j meeting his_{i,j} aunt'

b. anguti.p tuqut.si.nir.a (F 1984: 46)
 man.Gen/Erg kill.AP.niq.3POSS(Abs/Nom)
 'the man's killing (of someone)'

Theme arguments in WG, like Inuktitut, have Gen/Erg case when the verb is passivized as in the *-niq* nominal in (39).

(39) nalu.aa [qinnuta.ata qanuq naammassi.niqar.ni.ssa.a] (F 1984: 45)
 not-know.IND3E/3A [request.3POSSGen/Erg how implement.PASS.niq.FUT.3POSS(Abs/Nom)]
 'she didn't know how his request would be implemented'

In examples like (40), where the theme argument has Gen/Erg, the V has the "transitive verbal base" (i.e., specific form)⁶ and is not passivized. Also in (40b) the morpheme *-ssa-* follows *-niq* suggesting that it is an adjectival modifier. If the *-niq* nominal were a gerund, *-ssa-* would be adverbial and precede *-niq*.

⁶In Inuktitut, for one of the verbs tested one informant allowed both the 'specific form' and the 'non-specific' form of the V with an agent subject as in (a) and (b). However, unlike WG (40), the Inuktitut examples could not be interpreted with the theme as subject. If the theme were to be subject, the verb was passivized as in (c).

- a. arna.up iniqunaqtu.up kuning.ni.nga
- b. arna.up iniqunaqtu.up kunik.si.ni.nga
 'the beautiful woman's (Ag) kissing'
 *'the beautiful woman's (P) kissing'
- c. arna.up iniqunaqtu.up kunik.tau.ni.nga
 'the beautiful woman's (P) kissing'

(40) a. anguti.p tuqun.nir.a (F 1984: 46)
man.Gen/Erg kill.niq.3POSS(Abs/Nom)
'the killing of the man'

b. [aja.mi naapin.ni.ssa.a] qilanaar.aa (F 1984: 46)
[maternal-aunt.3ReflPOSS/Erg/Gen meet.niq.FUT.3POSS(Abs/Nom)] look-forward-to.IND3E/3A
'he, looked forward to meeting his, aunt'

I suggest that forms like (40), with the object having Erg/Gen case and the "transitive verbal base" are not gerunds but deverbal nominals (see also Section 4.4.5); and hence, the Erg/Gen case marking like other theme adnominals discussed (see Section 4.2).

Of interest here is the case marking in gerunds in (41) where the subject has Erg/Gen and the object Inst/Acc.

(41) nanu.up qimmir.mik kii.si.ni.nga
polar-bear.Gen/Erg dog.Inst/Acc bite.AP.niq.3POSS(Abs/Nom)
'the bear's biting the dog'

This case marking pattern is similar to that of languages Bittner and Hale (1996: Section 11) term "Three-Way Languages" where transitive sentences have Erg-Acc case marking as in (42), except that both Erg and Acc are considered universal structural cases,⁷ whereas Erg and Inst involve a universal and an oblique case.

(42) a. arengke-le aye-nhe ke-ke (Antekerrepenhe B&H: p. 51)
dog-Erg me-Acc bite-PAST
'the dog bit me'

Thus the explanation for the case marking of the gerund in (41) must incorporate explanations for Erg assignment and for Inst assignment (see Chapter 3, Section 3.4) with the configuration for gerunds in (36b). This is represented by (43).

⁷In the Erg-Acc sentences there is a functional D adjoined to V to assign Acc (a universal structural case). There is no case competitor for the Erg subject so extra NP structure is posited. For the complicated explanation see Bittner and Hale (1996: 52-53).

The structures in (43) would be able to explain the Erg subject *nanu.up* and the Inst/Acc object *qimmir.mik*. The D case-binds KP_i (the case competitor is *-niq*), and by the Realization Conventions KP_i gets Erg.

(43) a. Bittner (1994a)

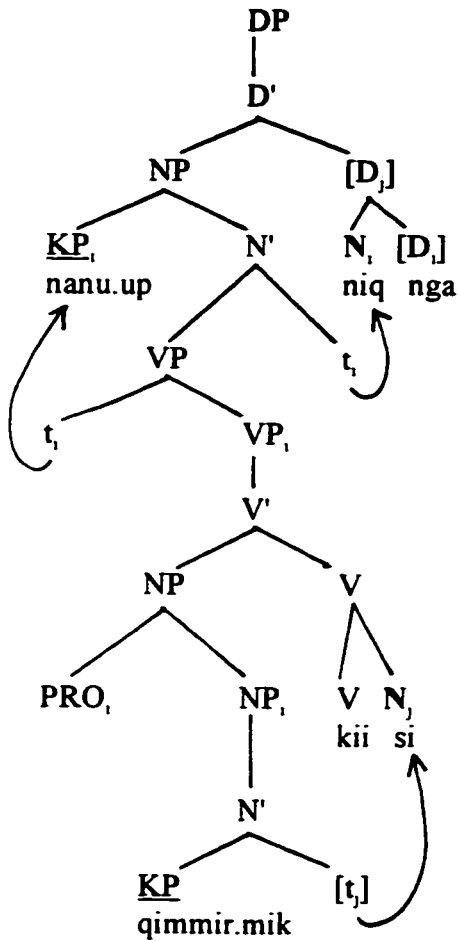

b. Bittner and Hale (1996)

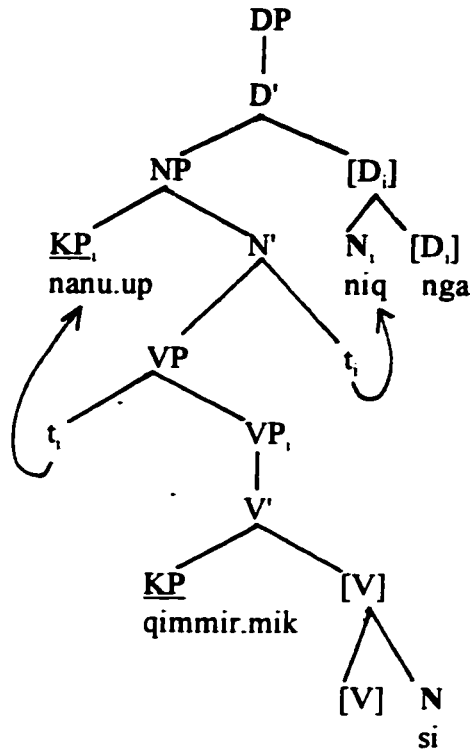

In Bittner (1994a) the trace of AP case-binds KP (the case competitor is the AP *-si-*), and by the language specific Realization Conventions for structural obliques, KP gets Inst. To create the case-binding configuration an odd situation is created whereby the trace of the AP is a case-

binder and the AP⁸ itself is the pseudo coargument. This is the only situation in which one argument chain (AP, t_j) fulfills two different functions simultaneously. It also has a noun trace (which is the trace of AP) assigning Inst/Acc case, and, indeed, the Realization Conventions for the objective case Inst refer to the case-binder as being a lexical head, i.e., it could be a N or a V. Yet for Inuktitut in Section 4.2 we saw that nouns do not assign Inst/Acc to theme adnominals. And it is also generally recognized that nouns do not assign objective case. The situation may be different in West Greenlandic. This is altered in Bittner and Hale (1996) where V is the case-binder as in (43b). V is generated from the lexicon with the AP, and the AP is the pseudo coargument. Though an N or its trace no longer assign Inst, the Case Realization Rules (1996: 7) still refer to a lexical head as the case-binder for Inst, instead of V as the case-binder. Once the Case Realization Rules for the Inst oblique is altered to have V the case-binder, then how would this case be different from Acc other than just by stipulation. Thus there is reason to doubt that the case-binding configuration is the correct explanation for case assignment in nominals.

4.4.5 Dual Case-Marking

In Bok-Bennema's analysis of noun phrases, there is an inflectional phrase NIP that dominates the NP. There is an inherent feature [+genitive] in NI which assigns Gen to [Spec, NI] in Spec-head agreement and which passes agreement on to NI. The head NI has features for the number of the head N and for agreement of the [Spec, NI]. Bok-Bennema (1991: 234-238) discusses

⁸Note that Bittner (1994a) generates the AP as the complement of the V with the Inst/Acc argument as the complement of the AP. Bittner and Hale (1996) generate the V+AP from the lexicon. Baker (1988) has the AP a N that incorporates into V with the Inst/Acc argument as a coindexed oblique. Bok-Bennema (1991) has the AP as a pro V that assigns Inst/Acc to the object (see Chapter 3, Section 3.5).

nominals formed with *-niq*. *-Niq* is an X-bar affix which selects a non-finite complement: CP if the complement has a PRO subject, VP otherwise.

Recall from Chapter 3, Section 3.5 that according to Bok-Bennema's analysis only ambiguous verbs can assign structural Acc case; and that most verbs cannot, in which case they use another strategy for assigning case to the object whereby the object can either adjoin to I' and be assigned Nom/Abs by the "auxiliary" I, or an AP auxiliary can assign Acc/Inst case to the object. In NIPs an object could not get Nom/Abs since there is no [+nominative] feature in I; but an object could get Acc either structurally from an ambiguous verb or from an AP. As Bok-Bennema's analysis of *-niq* nominals in her Chapter 5 preceded her analysis of *-mik* as structural Acc case, I have modified her explanation for case marking in the nominals to reflect this.

Bok-Bennema uses the example in (44a) from Fortescue (1984: 46) to show how *-niq* nominals with CP complements assign case. It is illustrated in (44b). Since [Spec, NI] is open, the object can move into it and get Gen case from the [+genitive] feature in NI. However this is movement of an object past a PRO subject. "This means that the spec, NIP position must be an A'-position, because otherwise the SSC [Specified Subject Condition] would be violated" (Bok-Bennema 1991: 236).⁹ Both ambiguous verbs and "unaccusative transitive" verbs would be able to assign Gen to their objects in this way. (Note that the subject of the CP complement of *-niq* must be PRO.)

⁹Recall from Chapter 2, Section 3.5 that moving the object past the subject in VP to [Spec, T] does not violate the SSC since the SSC refers to extraction past the subject in an NP or an S (=IP) projection. However in (44) the object is moved past a subject and outside CP (=S') which would be a SSC violation. Thus Bok-Bennema's requirement that the object cannot be moving to an A-position.

- (44) a. [aja.mi naapin.ni.ssa.a] qilanaar.aa (BB: p. 236)
 [aunt.3POSSRefI/Gen/Erg meet.niq.FUT.sg3sg(Abs/Nom)] look-forward-to.IND3E/3A
 'He looked forward to meeting his aunt'

b.

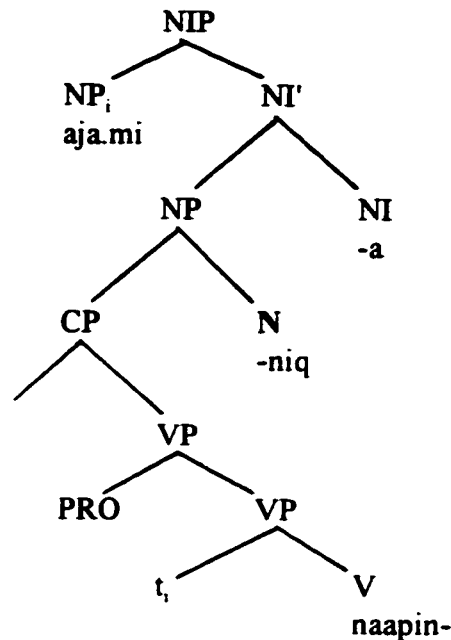

In (45a) the nominalizer *-niq* selects a VP complement. The subject moves to [Spec, NI] where it gets Gen. The object gets Acc from the V since *tusaan-* belongs to the ambiguous class of verbs.¹⁰ Bok-Bennema's example in (45) is the Labrador dialect taken from Smith (1973).

- (45) a. qimmi.up tusaan.ni.nga sivanim.mik (BB: p. 236)
 dog.Erg/Gen hear.niq.3POSS(Abs/Nom) bell.Inst/Acc
 'the dog's hearing the bell'

¹⁰For the example in (44) the structure and sentence are given as Bok-Bennema had them. But for the example in (45) there are three differences from the analysis in Bok-Bennema (1991: 236). For (45a) she has a null AP morpheme, but in the final chapter she argues against null APs and says the verbs that occur without an overt AP are ambiguous verbs and can assign Acc. Consequently the null AP is omitted. For diagram (45a) she has *sivanim.mik* generated as a PP, saying that VP complements of *-niq* must be intransitive because there is no way for an object to get case. Since these verbs were reanalyzed as ambiguous verbs that can assign structural Acc case, the *sivanim.mik* complement is shown as an NP with Acc case and *tusaan.ni.nga* is considered to be an ambiguous verb that is the complement of *-niq*.

b.

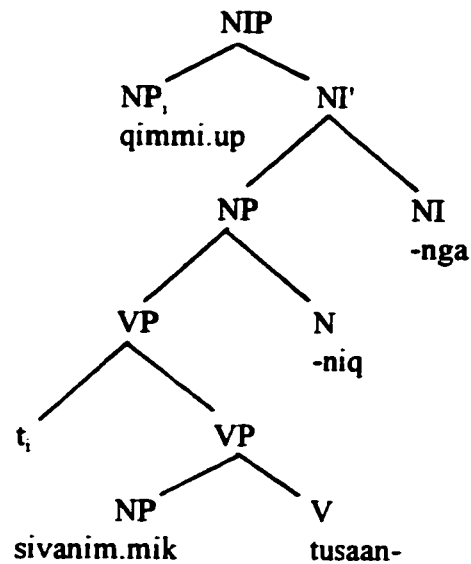

Example (45) illustrates an ambiguous verb, but if the verb belonged to the "unaccusative transitives", then an AP would assign Acc to the object with the AP heading a projection above the VP but below the *-niq* nominalizer as in (46a) and given in the example in (46b) from Fortescue (1984: 45).

(46) a. $[_{NIP} NI [_{NP} N [_{VP} AP [_{VP} NP [_{VP} V [_{NP}]]]]]]]]$

b. [ikinngum.mi.nik tuqut.si.nir.a] tussaur.para (BB: p. 67)
 [friend.3POSSRefl.Inst/Acc kill.AP.niq.3POSS(Abs/Nom)] hear.IND1E/3A
 'I heard of his, killing his, friend'

As discussed in Section 4.4.4, examples like (44) where the object moves to [Spec, NI] and has Gen case are probably deverbal nominals formed with *-niq*, on a par with *-ing* deverbal nominals in English as in *the eating of the meat*. Thus there is no need to have [Spec, NI] as an A-bar position to avoid a SSC violation since adnominals are optional. Additional evidence that (44) is a deverbal nominal is provided by the location of the affix *-ssa-*. With *-niq* nominals an adverb can follow the verb stem but precede *-niq* as in (47a) and (47b), and adjectival

modifiers follow *-niq* as in (47c).

(47) a. *pisuk.pang.ni.nga*
walk.often.niq.3POSS(Abs/Nom)
'his often walking'

b. *pisu.nngin.ni.nga*
walk.NEG.niq.3POSS(Abs/Nom)
'his not walking'

c. *saglu.ni.alu.ga*
lie.niq.big.1POSS(Abs/Nom)
'my bad lying'

The affix *-ssa-* means 'future' and can be used adverbally or adjectivally. Bok-Bennema omitted an explanation for where *-ssa-* would be structurally. However, since it occurs after *-niq* it would be an adjective and *naapin* would be a deverbal nominal. Had *-ssa-* preceeded *-niq* then we would consider it an adverb which would be evidence of a gerundive nominal.

The modification of her analysis for the example (45) explains having a Gen/Erg subject and an Acc/Inst object in the gerund. Although the configuration is similar to what I proposed in Chapter 1, there are substantial differences. First she has NI assigning Gen and V assigning Acc; while I have V assigning Gen/Erg to the subject and Inst/Acc to the object through *-mik* insertion. While looking at just the gerunds may not provide conclusive evidence as to which model is correct, if the checking of case is related back to the checking of case in clauses, then my analysis is to be preferred. Bok-Bennema's requires many stipulations that resulted in her describing Inuktitut as having a very marked system of case. My analysis required no new stipulations and the case of arguments in gerunds falls out naturally from the case on arguments in clauses. As well my analysis was able to explain what, at first, seemed like puzzles in the Minimalist Program, in particular, objects moving past subjects.

4.5 Summary

Adnominals of underived and derived nominals have Gen/Erg case. Example (3a) is reproduced here as (48). The head N *puuqata* assigns the Gen/Erg case to its two arguments: the subject *taami* and the object *kikiat*. In Section 4.2.3 it was suggested that Gen/Erg is checked after Spell-out. Thus after Spell-out the theme adnominal would adjoin to NP and be in a Spec-head checking relation with the head N. Since the possessor adnominal is already in a Spec-head checking relation, it is not necessary that it move. However, whether it moves for checking, and whether it moves before or after the theme moves does not affect my argument.

- (48) *taami.up kikia.ngita puuqata.quti.ngat*
Tommy.Gen/Erg nail.pl3POSSGen/Erg sack.own.3plPOSS(Abs/Nom)
'Tommy's sack of nails'

Arguments of gerunds have Gen/Erg case for the subject and Inst/Acc for the object as illustrated in (19), reproduced here as (49).

- (49) *nanu.up qimmir.mik kii.si.ni.nga*
polar-bear.Gen/Erg dog.Inst/Acc bite.AP.niq.3POSS(Abs/Nom)
'the bear's biting the dog'

The head V *kii-* assigns the Erg/Gen case to its subject *nanuq* in [Spec, V], and the V assigns Inst/Acc to its object *qimmiq* through insertion of the postposition *-mik* which would check the case of the theme argument *qimmiq*.

Chapter 5

Agreement

5.1 Introduction

In Chapter 2 I showed that speaker's intentions to make reference to a particular object results in movement of the object at Spell-out (S-structure) in ergative languages, whereas movement does not occur until LF in accusative languages. I also showed that marking speaker intentions at Spell-out rather than LF accounts for the pattern of Erg/Gen-Abs/Nom case marking and that a separate parameter is not required to account for the existence of ergative versus accusative languages. And I showed that it can also account for sentences in ergative languages having either Erg/Gen-Abs/Nom or Abs/Nom-Inst/Acc case marking without having to refer to Abs/Nom-Inst/Acc case marked sentences as "intransitive" with a direct object.

In Chapter 3 I showed that five different parametric explanations for the existence of ergative versus accusative languages were empirically and theoretically inadequate. And in Chapter 4 I showed that the case marking on arguments of nouns and gerunds can be explained by the account I developed in Chapters 1 and 2. However, up to this point I have focussed on case marking and in this chapter I will show that the pattern of agreement is also explained.

Ergativity can be indicated by case marking on nominals or by agreement marking on the verb, or by both. Inuktitut has both case marking on nominals and agreement morphemes on the verb. The order of the agreement morphemes in specific sentences has been described as $T+Agr_S+Agr_O$. This order is based on the agreement found in subordinate and main moods. For

example, with 2nd person subjects¹ and 1st person objects in the main moods there can be agreement² for the subject *-ng-* 'you' and for the object *-nga* 'me' as in (1a); and with 3rd person subjects and 1st or 2nd person objects there is agreement for the subject and object as in (1b).

(1) a.	2E subject T+Agr _s .Agr _o	b.	3E subject T+Agr _s +Agr _o
Declarative, 1A:	-va.ng.nga	1A:	-va.a.nga
Interrogative, 1A:	-vi.ng.nga	1plA:	-va.a.tigut
Optative, 1A:	-ng.nga	2A:	-va.a.tit
		2plA:	-va.a.si

However, with 3rd person objects in the declarative mood, the order of the agreement morphemes is T+Agr_o+Agr_s. Both 1st and 2nd subjects tend to be unmarked when the object is 1st or 2nd person. And with 3rd person objects, the subject is marked and the object is unmarked; so it is difficult to describe an ordering in the agreement morphemes. But when the 3rd person object is plural (or dual), the object number agreement precedes subject agreement. This pattern of agreement³ is illustrated in (2) (data from Harper 1974: 33).

(2) Declarative Mood:	1E subject	2E subject
	T.Agr _o .Agr _s	T.Agr _o .Agr _s
Object:	3A -va.ra	-va.it
	3dA -va.ak.ka	-va.ak.kik
	3plA -va.k.ka	-va.t.it

¹Recall that the terms "subject" and "object" refer to the thematic arguments of the verb and not to the syntactic position in the sentence. To refer to the latter, terms such as "syntactic subject" or "sentence subject" are used.

²There are alternate forms for agreement for 2nd person subjects and 1st person objects. For the North Baffin (Igloolik) dialect, Dorais (1978: 32) gives *-va.ng.nga* for the declarative and *-vi.ng.nga* for the interrogative, but Mallon (1991: 9, 19) and Harper (1974: 33, 36) give *-var.ma* and *-vi.nga* respectively. For the optative mood Dorais (1978: 33), Mallon (1991: 25) and Harper (1974: 41) all give *-ng.nga*. I have shown the declarative and interrogative forms as Dorais gives them to illustrate the order when agreement is marked for subject and object.

³Dual is marked by doubling the last vowel and adding a final *-k* (a final C would be deleted). Plural is marked by adding *-it/-t*.

(Ulving (1987): $ga < *ka$; $va.ra < *var+ga$; $k.ka < *t+ka$)

Thus there are two orders for agreement morphemes (cf. Zager (1980), and Vaxtin (1979) for the Chaplino dialect of Asiatic Eskimo, and Reed et al (1977: 61, 140) for Yup'ik). However, this is so only for the main moods. The order $T+Agr_S+Agr_O$ is more common, especially for interrogative and optative moods⁴ (see data in Harper 1974: 36-41). In subordinate moods the agreement order is $T+Agr_S+Agr_O$ for all subjects and all objects.

This study has taken the position that functional AgrPs do not exist. If there were separate Agr projections associated with checking case and agreement, it would be difficult to explain the existence of the two agreement orders: Agr_S+Agr_O and Agr_O+Agr_S . It would also be difficult to explain why the order Agr_O+Agr_S occurs with any subject and 3rd person objects in the declarative, but only with 1st person subjects and 3rd person objects in the optative, and only with 1st person singular subjects and 3rd person objects in the interrogative. It would also be problematic because, for both agreement orders, the case of the object is Abs/Nom and the case of the subject is Erg/Gen. The agreement order for the questions in (3) is Agr_S+Agr_O , and the subject has Erg/Gen as in (3b) and (3c), and the object has Abs/Nom as in (3a). For the declarative examples in (4) and (5) the agreement order is Agr_O+Agr_S , yet the subject has Erg/Gen in (5) and the object Abs/Nom case in (4) and (5).

- (3) a. *ippaksaq Jaani taku.lau.ngngit.ta.it?* (S I: p. 65)
yesterday Johnny(Abs/Nom) see.PAST.NEG.Q.2E(3A)
'didn't you see Johnny yesterday?'

⁴In the main moods, agreement paradigms list 63 combinations for the 9 possible subjects (1 sg, d, pl; 2 sg, d, pl; 3 sg, d, pl) with the 9 possible objects (1sg, d, pl; 2 sg, d, pl; 3 sg, d, pl). The 81 possible combinations are reduced by the impossible combinations involving 1E/1A and 2E/2A.

- b. *kia angiqqauti.niar.pa.a.nga?* (S II: p. 69)
 who(Erg/Gen) bring-home.FUT.Q.3E.1A
 'who's gonna take me home?'
- c. *kia angiqqauti.va.a.tit?* (S II: p. 69)
 who(Erg/Gen) bring-home.Q.3E.2A
 'Who brought you home?'
- (4) a. *naja.ga uqauti.va.ra* (S I: p. 57)
 sister(of a man).1POSSAbs/Nom speak-to.IND(3A).1E
 'I spoke to my sister'
- b. *nattiq tamanna niri.junna.ngngit.ta.ra* (S II: p. 28)
 seal(Abs/Nom) here(Abs/Nom) eat.able.NEG.IND(3A).1E
 'I can't eat this seal-meat here'
- (5) a. *taassuma tuulli.up tasir.mut turaar.ta.nga inuk* (S I: p. 78)
 that(Erg/Gen) loon.Erg/Gen lake.All direct.IND.3A(3E) man(Abs/Nom)
 'the loon directed the man towards a lake'
- b. *anguti.up aaqqik.pa.a qukiut* (S I: p. 64)
 man.Erg/Gen fix.IND.3A(3E) gun(Abs/Nom)
 'the man fixed the gun'
- c. *ilinniaqtittiji.up uqauti.va.a Jaani* (S I: p. 64)
 teacher.Erg/Gen speak-to.IND.3A(3E) Johnny(Abs/Nom)
 'the teacher spoke to Johnny'

It was shown in Chapter 3 that Bobaljik's and Murasugi's parametric accounts gave the wrong ordering of agreement morphemes for Erg/Gen-Abs/Nom sentences, and had syntactic heads intervening between the AgrPs. Both Johns' and Bittner's explanations can account for the adjacency of subject and object agreement morphemes in Inuktitut; however their models, which were rejected for explaining case, cannot account for the two agreement orders as they have the agreement morphemes determined by a particular agreement assigning head. For Bittner (1994a), an Abs/Nom object is not case bound and Nom/Abs agreement is in C, and an Erg/Gen subject is case bound by I and Erg/Gen agreement is in I.

This chapter will account for the pattern of agreement found in Inuktitut. In Section 5.2 I use the Minimalist Program to explain the agreement pattern, and in Section 5.3 I show how an explanation for some of the patterns of agreement morphemes in Inuktitut naturally falls out from the analysis in Section 5.2. The concluding section discusses how the two agreement orders (T+Agr_S+Agr_O and T+Agr_O+Agr_S) are explained by the distinction between the two interface levels PF and LF. While speaker's intentions to pick out a particular object is relevant to the conceptual-intentional level, the ordering of agreement morphemes is relevant to the articulatory-perceptual level. Thus the former affects semantic interpretation since scope and quantification are affected with readings dependent upon whether the feature is checked at Spell-out (ergative languages) or at LF (accusative languages), while the latter does not affect the semantic interpretation.

5.2 Agreement as a Manifestation of a Spec-head Relation

Earlier work in the Minimalist Program maintained the two agreement projections where the Agr heads were functional categories for checking case and agreement features. But Chomsky (1995: Section 4.10) suggests that there are no AgrP functional projections, though agreement and case are still checked in a Spec-head relation. Others who have argued against Agr heading a functional or independent category include Speas (1991) and Spencer (1992). This section shows that agreement and case, both being Spec-head relations, can explain the agreement morphemes found in specific and non-specific sentences in both main clauses and in subordinate clauses.

Both case and agreement are manifestations of a Spec-head relation, with case being on

the NP in the Spec position and agreement being on the V/N head. Since Erg/Gen is assigned⁵ by V (or by N) and Abs/Nom is assigned by T, the first issue to be addressed is why the agreement for the Erg/Gen subject immediately follows the T. Examine the examples in (6). In the main clause in (6a)⁶ the declarative mood marker is *-ja-* and the subject agreement *-a-* and the object agreement *-tit*.

- (6) a. Naalagak Jisusi, Ataata.p tili.ja.a.tit, ...
 Lord Jesus, Father.Erg/Gen send-s.o.-to-do-s.t..IND.3E.2A
 'Lord Jesus, the Father sent you ...'
- b. sivullirmi tukisi.junna.lau.nngit.ta.ra (S I: p. 67)
 at-first understand.able.PAST.not.IND.(3A)1E
 'I couldn't understand him at first'
- c. tukisi.gu.ni.uk ... (S I: p. 102)
 understand.COND.3ssE.3A ...
 'If he understood it ...'

The mood marker in the main clause in (6b) is also the declarative *-ta-* with 1st person subject agreement *-ra* and no overt 3rd person object agreement. In (6c) *-gu-* is the subordinate mood marker with 3rd person reflexive (i.e., same subject as main clause) agreement *-ni* and 3rd person object agreement *-uk*.

The trees in Figure (7) are drawn for the examples in (6). The heads are bound

⁵In Chapter 1 I described how, in the Minimalist Program, lexical items (LI) were inserted with Ns fully marked for all Φ features and case. For example, case would be added to the LI either in the numeration or in the selection. I also pointed out that Chomsky (1995a: 275) mentioned that it would not create major difficulties to the Minimalist Program if this were not the situation. In Section 1.4.3 I argued that the structural cases Nom/Abs and Erg/Gen are assigned rather than added to the LI in the selection. Consequently I used the term "assigned" instead of "checked". My analysis is not affected if LIs are selected marked with structural case.

⁶Example (6a) is from page 2 of *Naalagak Nirturlavut*. Canada: Katulimmiutait Uppiaqatigiiktut Nunavummiitut piqutigijangit, 1992.

morphemes (affixes), so that the agreement for the subject NP_S in a Spec-head relation with V is at the end of V, which happens to be at the end of T. Thus in (6a) and (6c), agreement for the NP in [Spec, V] is after V+T, while in (6b) it is after V+Aux+PAST+Neg+T.

(7) a.

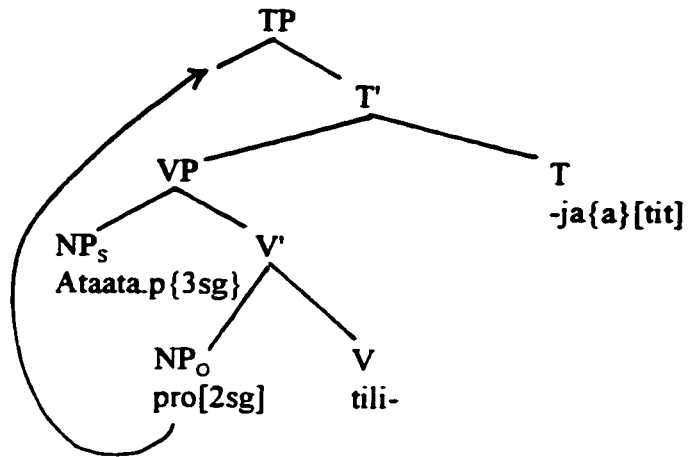

b.

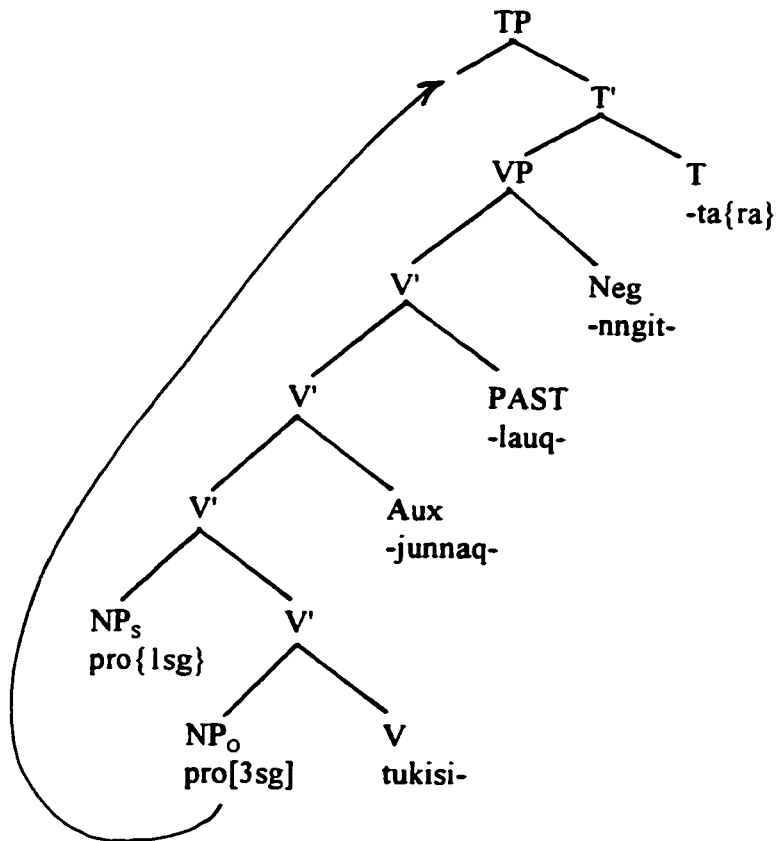

c.

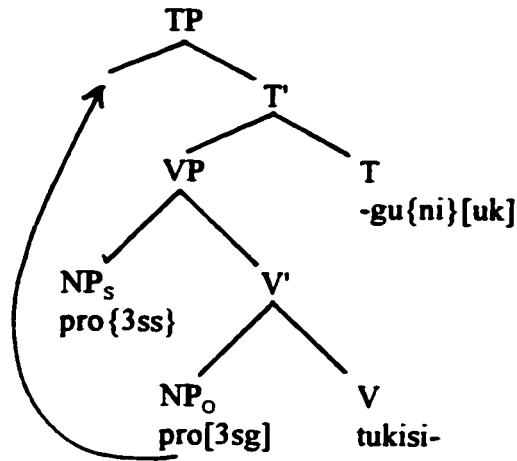

In specific sentences the subject NP_s is in a Spec-head relation with V and an overt NP is assigned Erg/Gen case and the agreement follows V+T; the object NP_o moves to [Spec, T] and is in a Spec-head relation with T assigning Abs/Nom case and agreement following T+Agr_S.

In non-specific sentences as in (8) the subject would have moved to [Spec, T] so that there is no Spec-head agreement relation between [Spec, V] and V. The subject NP_s is in a Spec-head relation with T and is assigned Abs/Nom case by T with agreement on the T. This is illustrated in (9).

- (8) pingasu.tuinnar.nik tusaq.tugut (S I: p. 12 (adapted))
 three.only.INST/ACC hear.IND1pl
 'we heard only 3'

(9)

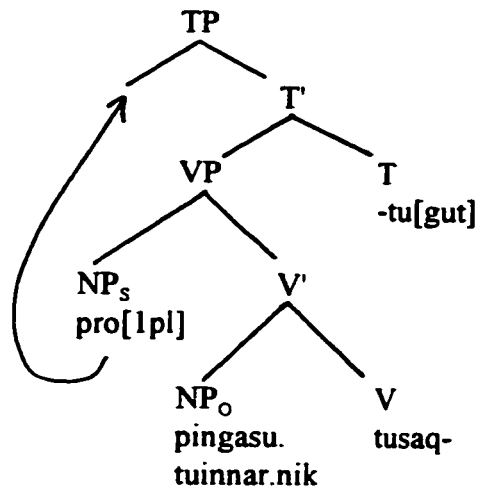

The type of sentence--specific or non-specific--will determine the number of agreement morphemes. Thus a specific sentence will have S and O agreement though both need not be overt, while a non-specific sentence will have only S agreement.

5.3 Agreement Patterns

In this section I look at the agreement patterns in main and subordinate clauses from the perspective of Abs/Nom agreement and of Erg/Gen agreement. With each type of agreement, the view of this paper is supported that agreement is not derived from distinct agreement heads. Rather the type of sentence as specific or non-specific determines whether there is Spec-head agreement with the subject and object or with only the subject, and the PF component determines the output of the head T with subject and object agreement or with subject only agreement.

5.3.1 Main Clause Agreement

Since in specific sentences NP_o targets T becoming [Spec, T], the agreement relation between NP_o and T, expressed as a Spec-head relation, will mean that agreement with the object NP_o (which has Abs/Nom case) should fall at the end after subject agreement. This is what happens as shown in the specific sentences in (10).

- (10) a. ulluluktaaq uqallak.vi.gi.laur.pa.a.nga (S II: p. 6)
 all-day-long chat.place.have-as.IND.3E.1A
 'he chatted with me all day long'
- b. Naalagak Jisusi, Ataata.p tili.ja.a.tit, ... ((6a) repeated here)
 Lord Jesus, Father.Erg/Gen send-s.o.-to-do-s.t..IND.3E.2A
 'Lord Jesus, the Father sent you ...'
- c. anguti.up aaqqik.pa.a qukiut (S I: p. 64)
 man.Erg/Gen fix.IND.3E/3A gun(Abs/Nom)
 'the man fixed the gun'

It is also expected that the agreement morpheme expressing the Spec-head relation between [Spec, T] and T would be the same whether the sentence was specific and the object NP_O was in [Spec, T] or non-specific with the subject NP_S in [Spec, T]. This is what we find as shown in the non-specific sentences in (11). Compare the specific examples in (10) with the non-specific examples in (11).

- (11) a. *kanani iglu.qaq.tu.nga* (S I: p. 15)
 down-there house.have.IND.1A
 'I live (have a house) down there'
- b. ... *uqa.runna.laaq.pu.tit* (S I: p. 77)
 ... speak.able.FUT.IND.2A
 'You will be able to speak ...'
- c. *ullumi aullar.niaq.tuq* (S I: p. 114)
 today leave.FUT.IND3A
 'He will leave today'

Table (12) compares the agreement endings for Abs/Nom objects in specific sentences⁷ with the agreement endings for Abs/Nom subjects in non-specific sentences⁸ in the declarative mood. As expected the Abs agreement endings correspond.

(12) a. Main moods with subject/object agreement (Declarative *-ja/ta-*, *-va/pa-*):

	1E	1plE	2E	2plE	3E	3plE
1A			-va.ng.nga	-va.psi.nga	-va.a.nga	-va.a.nga
1dA			-va.tti.guk	-va.tti.guk	-va.a.ti.guk	-va.a.ti.guk
1plA			-va.pti.gut	-va.pti.gut	-va.a.ti.gut	-va.a.ti.gut

⁷ The agreement morphemes are shown for the main moods: declarative *-ja/ta-* and *-va/pa-* and negative declarative *-la-*. These agreement morphemes also apply to the other main moods: interrogative and optative; however, the listing of these mood morphemes is not as straightforward. Table (12) is simplified by excluding the dual forms for the subjects and alternate forms such as 2E/1A *-var.ma* and 1plE/2plA *-va.p.si* (3A objects are excluded from the table).

⁸ Endings in Table 12b are for declarative/indicative. These endings are also the same for the interrogative and optative moods except that for the 1st person dual and 1st person plural. For the interrogative, the endings are: *-vu.nga?* 'I', *-vi.nuk?* 'we (two)', *-vi.ta?* 'we'. For the optative, the endings are: *-la.nga* 'I', *-luk* 'we (two)', *-ta* 'we'.

2A	-va.git	-va.pti.git	-va.a.tit	-va.a.tit
2dA	-va.s.sik	-va.s.sik	-va.a.sik	-va.a.sik
2plA	-va.s.si	-va.s.si	-va.a.si	-va.a.si

b. Main moods with subject agreement only (Declarative *-ju/tu-*, *-vu/pu-*):

	1A	2A	3A
sg.	-vu.nga	-vu.tit	-vuq
d.	-vu.guk	-vu.sik	-vu.k
pl.	-vu.gut	-vu.si	-vu.t

For the other two main moods (interrogative and optative) the boldfaced agreement endings in Table 12a are the same with only slight variation in a few of the morphemes preceding the Abs/Nom agreement.

In this chapter I argue that the Spec-head relations between an NP in [Spec, T] and an NP in [Spec, V] determine whether there will be subject and object agreement or only subject agreement. I also argue in this chapter that the particular manifestation of subject and object agreement is a property of PF. This is supported by the analysis of the agreement patterns in specific sentences that are described in the following subsections.

5.3.1.1 Intervening Morphemes

First, with $Agr_S + Agr_O$ agreement as shown in (12a), with non-singular subjects and/or objects, other information is encoded in the agreement before the number and person agreement associated with the Abs/Nom argument. For example, while *niri.ju.gut* 'we ate' has *-gut* for 1plA subject, *taku.ja.pti.gut* 'you saw us' has *-gut* for 1plA object, and there is some extra material *-pti*. This extra material *-pti-* occurs with both 2E/1plA and 2plE/1plA, and with 1plE/2A. This other information is not agreement with the Erg/Gen subject. In 2E/1plA *-pti-* is associated with the 1plA *-gut* and would be part of Abs/Nom agreement, while in the latter *-pti-* is associated with the 2plE and would be part of Erg/Gen agreement (Abs/Nom agreement for 2A is *-git*). This

intervening material can be further decomposed into meaningful units (cf. Zager 1980), but the actual decomposition will not be analyzed in this study. What is important is that this material results from information about the subject agreement and the object agreement and it would be difficult to explain its occurrence if there were separate agreement heads. Rather there is information about the subject through the Spec-head relation with V and information about the object through the Spec-head relation with T, and PF determines the actual phonological form of T and subject agreement and object agreement.

5.3.1.2 Agreement on Possessed Nominals in Abs Case

Second, for 3rd person objects in the declarative the agreement order is Agr_O+Agr_S as shown in (13a).⁹ This agreement is the same as that on possessums in Abs/Nom case as shown in (13b).

(13) a. Main moods with agreement for subject and object (Declarative *-ja/ta-*, *-va/pa-*):

	1E	1plE	2E	2plE	3E	3plE
3A	-va.ra	-va.vut	-va.it	-va.si	-va.nga	-va.ngat
3dA	-va.ak.ka	-va.a.vut	-va.ak.kik	-va.as.si	-va.a.ngik	-va.a.ngik
3plA	-va.k.ka	-va.vut	-va.t.it	-va.si	-va.ngit	-va.ngit

b. Possessor agreement and object in Abs/Nom Case

	1E	1plE	2E	2plE	3E	3plE
sgA	-ga	-vut/-kput	-it	-si	-nga	-ngat
dA	-ak.ka	-ak.put	-ak.kik	-as.si/ak.si	-a.ngik	-a.ngik
plA	-k.ka	-vut/kput	-t.it	-si	-ngit	-ngit

(Ulving (1987): ga < *ka; va.ra < *var+ga; k.ka < t+*ka)

This parallelism between the agreement morphemes on the verb for 3A object and the agreement suffixes on possessed nominals with Abs/Nom case has been noted by, for example, Lowe (1985) for Siglit, Johns (1987) for Inuktitut, Ulving (1987) for West Greenlandic, Mennecier and Robbe

⁹The alternate forms *-vaa* for 3E/3A, *-vait* for 3E/3plA, *-vaat* for 3plE/3A and *-vait* for 3plE/3plA have not been listed in Table 13a.

(1994) for East Greenlandic.

The examples in (14) illustrate this parallelism. The diagrams in (15) show how it is possible for agreement of 3A objects in Table 13a and Abs/Nom possessums in Table 13b to have the same agreement.

(14) a. anguti.up taku.va.ngit
 man.Erg/Gen see.IND.3plA(3E)
 'the man sees them'

b. anguti.up iglu.ngit
 man.Erg/Gen house.pl3POSS
 'the man's houses'

In (15a) the subject NP_S is in a Spec-head agreement relation with V, with agreement following V+T. The object NP_O moves to [Spec, T] and is in a Spec-head relation with T with agreement following V+T+Agr_S, and the PF component determines the phonological output.

(15) a. Specific Verb Agreement

b. Possessive Agreement

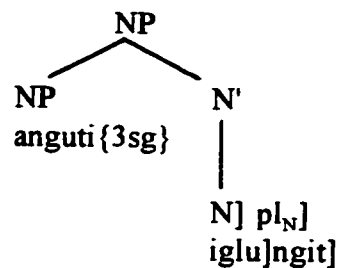
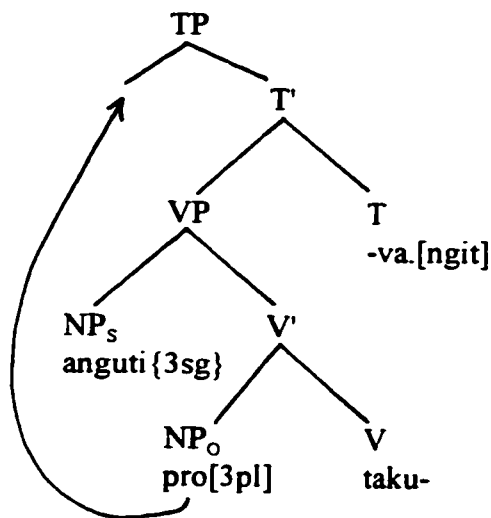

In (15b) the possessor (subject) is in a Spec-head agreement relation with the head N. The number of N would be suffixed to N, since in the Minimalist Program the LI (lexical item) would be selected with features such as number. Spec-head agreement between the possessor (subject) and the plural N then follows the N+pl. In both examples the 3rd person singular subject is unmarked. Sproat (1992: 244) points out that "languages commonly use the same series of

affixes both to mark person/number agreements on verbs and possession on nouns" and that, by marking affixes with person and number features, the same affix "could then be interpreted as agreement markers on verbs and possessives on nouns."

Table (13a) shows that, with 1E and 2E subjects, the number of the dual 3rd Abs/Nom object is marked, and if the 1E or 2E subject is singular the plural agreement of a 3A object is indicated. Agreement for 3E subjects shows that there is subject agreement if the 3A object is singular, but if the 3A object is dual or plural, then there is object agreement but no subject agreement.¹⁰ The interdependence between the features of the subject and of the object argues against having separate agreement heads, and argues for the PF component determining the output of the agreement information on the subject and the agreement information on the object. The nature of the PF component that determines the output as $T+Agr_O+Agr_S$ for 3rd person objects is left for future investigation. However the explanation is not that declarative verbs are actually nouns (see Nominalist Approach discussed in Chapter 3) since this order of agreement morphemes also occurs with some 3rd person objects in the interrogative and in the optative moods (see Appendix A).

¹⁰In the Greenlandic literature there is a slightly different contrast for the 3E/3A combinations.

	3E	3plE
3A	-va-a	-va-a-t
3plA	-va-i	-va-i-t

Ulving (1987) describes *a* and *i* as referring to the singular and plural N in relationship to the possessor and for verbs as referring to the singular and plural V in relationship to the subject. Ulving cites Bergsland (1955) as describing *a* and *i* as "referential number suffixes" which indicate number of 3rd person object, and *o* and *t* as "pure number suffixes" which indicate 3rd person subject. Since this distinction does appear in the paradigms in Inuktitut, I will analyze the 3E/3A combinations as there being subject agreement for 3E or 3plE if 3A is singular and object agreement only if 3A is dual or plural.

5.3.2 Subordinate Clause Agreement

In the previous section I showed that the agreement was not the output of separate agreement heads. This was illustrated in two ways. First material that could not be associated with a particular agreement head is observed to occur with specific sentences. Second, for some moods and some subject and object combinations the agreement order is $Agr_o + Agr_s$ rather than $Agr_s + Agr_o$. In this section I provide further evidence that agreement is not a separate or functional head: agreement of Abs/Nom subjects in subordinate clauses is different from the agreement of Abs/Nom subjects in main clauses, in subordinate clauses the Abs/Nom agreement of subjects is not the same as the Abs/Nom agreement of objects, and the Abs/Nom agreement of subjects in subordinate clauses is the same as the agreement for the possessor that is on possessums with Erg/Gen case. Again the evidence suggests that Spec-head relations provide the information on the features of the subject and/or object but the information is processed by the PF component and not that the PF component applies to already formed agreement morphemes.

5.3.2.1 Agreement of Abs/Nom Subjects in Subordinate vs. Main Moods

First, the agreement endings for Abs/Nom subjects in main mood clauses, given in Table 12b in Section 5.3.1 and repeated here as (15a), are not the same as the agreement endings for Abs/Nom subjects in subordinate mood clauses (becauseative, conditional, frequentive, dubitative) as shown in (15b).¹¹

¹¹The endings in Table 15b are taken from Harper (1974): 17-18. He also lists alternate forms for 2dA (-*ga.psik* and -*ga.tsik*), for 2plA (-*ga.psi* and -*ga.tsi*), and for 1plA (-*ga.pta*).

(15) a. Main moods with subject agreement only (Declarative *-ju/tu-*, *-vu/pu-*):

	1A	2A	3A
sg	-vu.nga	-vu.tit	-vuq
d	-vu.guk	-vu.sik	-vu.k
pl	-vu.gut	-vu.si	-vu.t

b. Subordinate moods with subject agreement only (Beclusative *-ga/(ng)ma-*):

	1A	2A	3ssA	3dsA
sg	-ga.ma	-ga.vit	-ga.mi	-(ng)ma.t
d	-ga.nnuk	-ga.ssik	-ga.mik	-(ng)ma.tik
pl	-ga.tta	-ga.ssi	-ga.mik	-(ng)ma.ta

The examples in (16) illustrate the contrast in endings between the subordinate and main mood endings. Also the 3ssA (reflexive) ending *-mi* in (16d) is contrasted with the non-coreferential 3dsA ending *-t* in (16c).

(16) a. tusa.rasuk.pak.ka.vit uqa.runna.laaq.pu.tit (S I: p. 77)
 understand.try-to.often.BECAUS.2A speak.able.FUT.IND.2A
 'You will be able to understand because you make the habit of trying to hear'

b. quvia.suk.kaanga.ma ingngi.ruma.qattar.tu.nga (S II: p. 60)
 happy.be.FREQ.1A sing.want.often.IND.1A
 'I regularly want to sing whenever I'm happy'

c. naassingujaang.u.jaraanga.t tuksia.riartu.qattar.tu.gut (S II: p. 59)
 Sunday.is.FREQ.3dsA church.go-for-purpose.often.IND.1plA
 'We regularly go to church on Sunday (whenever it's Sunday)'

d. atausiq kisiani quini.niqsa.u.ga.mi angi.gasuk.ka.mi tuqu.lau.ngngit.tuq (S I: p. 78)
 one(Abs/Nom) however fatten.COMP.be.BECAUS.3ssA go-out.try-to.BECAUS.3ssA
 die.PAST.NEG.IND3A
 'only one man, because he, was better nourished and fat, and because he, tried to get out, didn't die'

If there were a separate agreement head for Abs/Nom agreement then we would expect that the Abs/Nom agreement for subjects would be the same in main clauses and in subordinate clauses; but as Table 15 shows this is incorrect. However if subject agreement is in a Spec-head relation

with the mood morpheme then the different moods could account for the different sets of agreement. Though the Abs/Nom agreement for subjects is different in main and subordinate moods, the Abs/Nom case marking of the subject is the same. Compare the Nom/Abs case of the subjects in the main moods in (17) with the Nom/Abs case of the subjects in the subordinate moods in (18).

(17) a. qiturngaq sila.mi.it.tuq (S I: p. 23)
 child(Abs/Nom) outside.in.location.IND3A
 'the child is outside'

b. Jaani pika.ni.ip.pa? (S I: p. 25)
 Johnny(Abs/Nom) up-there.in.location.Q3A
 'Is Johnny up there?'

(18) a. ilaanni nuna.vut ikkiimaktualu.u.ngma.t (S I: p. 77)
 sometimes land.3plPOSSAbs/Nom very-cold.be.BECAUS.3dsA
 'Because our land is sometimes very cold,'

b. tuullik aanniq.tau.laur.ma.t inung.mut (S I: p. 77)
 loon(Abs/Nom) hurt.PASS.PAST.BECAUS.3dsA inuk.All
 'A loon was hurt by an Eskimo'

c. uqausi.ngit naalauti.kku.ur.ma.ta ... (S I: p. 84)
 word.pl3POSSAbs/Nom radio.by-way-of.movement.BECAUS.3dsA ...
 '... because his words came via radio'

5.3.2.2 Agreement of Abs/Nom Subjects vs. Abs/Nom Objects in Subordinate Moods

In the main moods, Abs/Nom agreement for Abs/Nom subjects is the same as for Abs/Nom objects. However, in subordinate moods, Abs/Nom agreement for subjects as in Table (15b) is not the same as the Abs/Nom agreement for objects as in Table 22a. Compare the examples in (19) and (20) that are in the subordinate moods. The Abs/Nom agreement for the 3A object in (19) is different from the Abs/Nom agreement for the 3A subject in the (20).

(19) a. tusa.raanga.mi.uk qimaa.tuinnar.tuq (S II: p. 60)
 hear.FREQ.3ssE.3A run-away.just.IND3A
 'he just runs away whenever he (same person) hears him'

b. ipi.raanga.gu miu.tuinnar.tuq (S II: p. 60)
 tie-up.FREQ.(3E)3A howls.often.IND3A
 'it just howls whenever he ties it up'

(20) a. pisuk.kaanga.mi aanni.qattar.tuq (S II: p. 60)
 walk.FREQ.3ssA hurt.often.IND3A
 'he regularly hurts whenever he (same person) walks'

b. sana.jaraanga.t aisima.qattar.tu.nga (S II: p. 60)
 work.FREQ.3A be-at-home.often.IND.1A
 'I always stay at home whenever she works'

In (21a) the Abs/Nom agreement *-nga* for the 1st person object is not the same as the Abs/Nom agreement *-ma* for the 1st person subject in (21b). And compare the Abs/Nom agreement *-pit* for the 2nd person subject in (21c) with the Abs/Nom agreement *-tit* for the 2nd person object in Table 22a.

(21) a. ... kisiani anaana.ma taku.ttai.li.qu.ngma.a.nga (S II: p. 98)
 ...however mother.1POSSErg/Gen see.same.process.ask.BECAUS.3E.1A
 '(I was actually going to see her) but my mother asked me not to'

b. qassi.nik niri.ngmangaar.ma qaujima.qquu.ngngit.tu.nga (S II: p. 20)
 how-many.INST/ACC eat.DUB.1A know.probably.NEG.IND.1A
 'I don't think I know how many I have eaten'

c. aullar.niar.mangaar.pit qauji.ngngi.la.tit.suli? (S II: p. 20)
 leave.FUT.DUB.2A know.NEG.NEG-Q.2A yet
 'Do you not know yet whether you will be leaving?'

Table (22a) illustrates the agreement endings in subordinate moods for subjects and objects.¹²

¹²The data in Table 18a is from Harper (1974): 42-44. He lists some alternate forms for the 1st and 2nd person subjects. For space considerations agreement for dual objects has been omitted as have dual subjects in all persons.

(22) a. Subordinate moods with subject/object agreement (Beclusative *-ga/(ng)ma-*):

	1E	2E	3ssE	3dsE
1A		-ga.vi.nga	-ga.mi.nga	-(ng)ma.a.nga
1plA		-ga.pti.gut	-ga.mi.ti.gut	-(ng)ma.a.ti.gut
2A	-ga.k.kit		-ga.mi.tit	-(ng)ma.a.tit
2plA	-ga.s.si		-ga.mi.si	-(ng)ma.a.si
3A	-ga.k.ku	-ga.vi.uk	-ga.mi.uk	-(ng)ma.gu
3plA	-ga.k.kit	-ga.vi.git	-ga.mi.git	-(ng)ma.git
	1plE	2plE	3ssplE	3dsplE
1A		-ga.psi.nga	-ga.mi.nga	-(ng)ma.a.nga
1plA		-ga.pti.gut	-ga.mi.ti.gut	-(ng)ma.a.ti.gut
2A	-ga.pti.git		-ga.mi.tit	-(ng)ma.a.tit
2plA	-ga.s.si		-ga.mi.si	-(ng)ma.a.si
3A	-ga.pti.gu	-ga.psi.uk	-ga.mi.djuk	-(ng)ma.gu
3plA	-ga.pti.git	-ga.psi.git	-ga.mi.git	-(ng)ma.git

The Abs/Nom agreement for 1st and 2nd person objects in subordinate moods is the same as in the main moods as shown in (22b) (Tables 12a and 13a are repeated here as Table 22b). The Abs/Nom agreement for the subordinate mood 3rd person object *-ku/gu* is not the same as with the main declarative mood though it is the same as that found in the interrogative and optative main moods (see Appendix A).

(22) b. Main moods with subject/object agreement (Declarative *-ja/ta-*, *-va/pa-*):

	1E	1plE	2E	2plE	3(ds)E	3(ds)plE
1A			-va.ng.nga	-va.psi.nga	-va.a.nga	-va.a.nga
1plA			-va.pti.gut	-va.pti.gut	-va.a.ti.gut	-va.a.ti.gut
2A	-va.git	-va.pti.git			-va.a.tit	-va.a.tit
2plA	-va.s.si	-va.s.si			-va.a.si	-va.a.si
3A	-va.ra	-va.vut	-va.it	-va.si	-va.nga	-va.ngat
3plA	-va.k.ka	-va.vut	-va.t.it	-va.si	-va.ngit	-va.ngit

And although the Abs/Nom 3rd person object agreement is different in subordinate and main moods, the subject has Erg/Gen case and the specific object has Abs/Nom case. With the conditional subordinate mood the subject has Erg/Gen case as in (23b) and the specific object has Abs/Nom case as in (23a).

- (23) a. Nattiqsuttuarju.up pi.nga tukisi.ttia.mmarik.ku.ni.uk ... (S I: p. 101)
 Nattiqsuttuarjuk.Erg/Gen (story).3POSSAbs/Nom understand.really.very.COND.3ssE.3A
 'If he really thoroughly understood Nattiqsuttuarjuk's story, ...'
- b. ui.ngata tiki.giar.ma.gu (S I: p. 122)
 husband.3POSSErg/Gen arrive.go-for-purpose.BECAUS.(3E)3A
 'Because her husband started to reach her,'

5.3.2.3 Agreement on Possessed Nominals in Erg/Gen Case

The third interesting pattern is that the Abs/Nom agreement for subjects in subordinate moods listed in Table (15b) and repeated here as (24a) is the same as the possessor agreement on nouns with Erg/Gen case (see also Menecier and Robbe (1994) for East Greenlandic). Only the non-coreferential 3rd person (4th column in (24a)) is different from the 3dsE possessor form. However for these 3dsA forms there are alternate endings as shown in the brackets in (24a) that Dorais (1978) describes as not being used much anymore. Table (24b) lists the agreement for singular possessors when the object is singular, dual or plural.

- (24) a. Subordinate moods with subject agreement only (Beclusative *-ga/(ng)ma-*):
- | | | | | | |
|----|----------|----------|---------|-------------|--|
| | 1A | 2A | 3ssA | 3dsA | $\left(\begin{array}{l} 3dsA \\ -(ng)ngat \\ -(ng)ngatik \\ -(ng)ngata \end{array} \right)$ |
| sg | -ga.ma | -ga.vit | -ga.mi | -(ng)ma.t | |
| d | -ga.nnuk | -ga.ssik | -ga.mik | -(ng)ma.tik | |
| pl | -ga.tta | -ga.ssi | -ga.mik | -(ng)ma.ta | |

- b. Possessor agreement with NP in Erg/Gen case:

	Possessor			
	1E	2E	3ssE	3dsE
3A	-ma	-vit	-mi	-ngata
3dA	-nnuk	-ssik	-mik	-ngata
3plA	-tta	-ssi	-mik	-ngata

In the (a) examples in (25)¹³ and (26) the Abs/Nom agreement for the subject is the same as the agreement on the possessum with Erg/Gen case in the (b) examples.

(25) a. ... nillia.llu.ni "kaak.ka.vit niri.git!" (S I: p. 78)
 ... cry.PART.3A "hungry.BECAUS.2A eat.OPT2A"
 '...crying "eat, because you are hungry"'

b. najak.pit illaiguti.nga (S I: p. 61)
 sister(of a man).2POSSErg/Gen comb.3POSSAbs/Nom
 'your sister's comb'

(26) a. najam.ma illaiguti.ngata ipu.a (S I: p. 61)
 sister(of a man).1POSSErg/Gen comb.3POSSErg/Gen handle.3POSSAbs/Nom
 'the handle of my sister's comb' (lit. my sister's comb's handle)

b. ilaak unikkaaqtuar.nia.ra.ma ... (S I: p. 77)
 yes tell-stories.FUT.BECAUS.1A ...
 'Yes, I'm going to tell a tale ...'

Figure (14) in Section 5.3.1.2 illustrates the syntactic configuration under which Spec-head agreement occurs for main mood specific sentences and for possessums in Abs/Nom case. Figure (27) illustrates the Spec-head relations for subordinate moods and for possessums.

(27) a. Intransitive Verb Agreement, Subordinate Mood b. Possessive Agreement, Erg/Gen Case

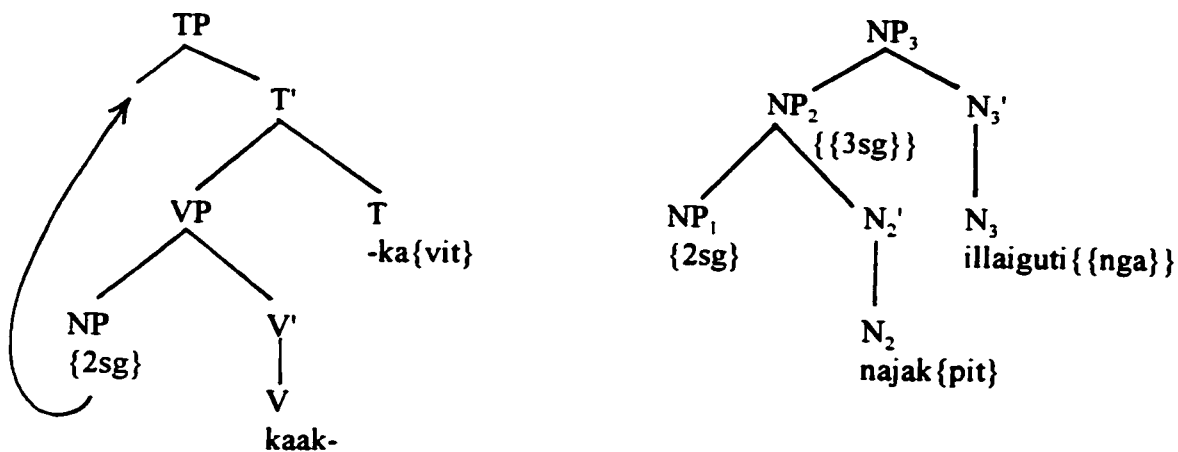

¹³Just as the declarative mood as *-va-* after a vowel and *-pa-* after a consonant, so also the 2nd person alternates between *-vit* after a vowel as in (25a) and *-pit* after a C as in (25b).

Figure (27) shows the Spec-head relations for deriving agreement for subordinate mood intransitive (and non-specific) sentences and for possessives with Erg/Gen case. In (27a) the NP subject moves to [Spec, T] and is in a Spec-head relation with the subordinate mood head T. The NP in Spec position gets Abs/Nom case and the PF component determines the output of the agreement with the subordinate mood head. In (27b) NP₂ is in a Spec-head relation with the head N₃ *illaiguti*: NP₂ is assigned Erg/Gen by the head N₃, and *illaiguti* agrees with its specifier. The NP₁ *pro*[2sg] is in a Spec-head relation with the head N₂ *najak*: *najak* agrees with its specifier and if *pro* had been an overt NP, it would be assigned Erg/Gen case by the head N₂. The PF component determines an output of *najak.pit* for NP₂ from the head *najak*, 2nd person agreement, and Erg/Gen case.

5.4 Conclusion

In this study I have claimed that speaker's intentions to pick out a particular entity result in a language being ergative if the intentions are marked at Spell-out and accusative if the intentions are checked after Spell-out. Furthermore, in ergative languages speaker's intentions to pick out a particular entity result in a sentence being specific with subject and object agreement if the speaker picks out a particular object, or non-specific with only subject agreement if the speaker does not pick out a particular object. In this chapter I showed that there are not separate Agr heads and that the PF component determines the actual phonetic output from information about the head, the case and the agreement.

The evidence against separate agreement heads was based on several distributional patterns of agreement morphemes. First an NP gets Abs/Nom case in a Spec-head relation with

a head T, but there is not a uniform Abs/Nom agreement. Abs/Nom subject agreement in main moods is the same as Abs/Nom object agreement but different from Abs/Nom subject agreement in subordinate moods. Second there are agreement morphemes that are not strictly related to Abs/Nom or to Erg/Gen agreement, but rather to the relationship of the subject and object to each other. The example mentioned in Section 5.3.1.1 was the morpheme *-pti-* that occurred with non-singular 1st person subjects or objects with specific agreement. Third, although the order in the agreement was for the subject then the object, with some 3rd person objects in the main moods the agreement order was object then subject. Lastly, Speas (1991: 413) points out a Spec-head agreement often leads to portmanteau morphemes of T+Agr_s. Examples of this can be seen in Inuktitut. For example, in the interrogative mood paradigms in (28) there is variation within the 1st person singular: if the object is 2nd person singular then the mood morpheme is *-va-*; but if the object is 3rd person singular then the mood morpheme is *-vi-*.

(28) Interrogative mood:

a. Specific sentences (subject and object agree.)			b. Non-specific sentences (subject agree.)			
1E	2E	3E	1A	2A	3A	
1A	-vi.ng.nga	-va.a.nga	sg.	-vu.nga	-vit	-va
2A	-va.git	-va.a.tit	d.	-vi.nuk	-vi.sik	-vak
3A	-vi.gu	-va.uk	pl.	-vi.ta	-vi.si	-vat

There is also variation across the subjects: for the 1st person the interrogative mood morpheme can be *-va-* or *-vi-*, for 2nd person the mood is *-vi-*, and for 3rd person the mood is *-va-*. This variation also supports the analysis whereby the ordering of the agreement with the mood is determined by the PF (articulatory-perceptual) level. The principles determining the PF output are not discussed in this chapter.

This presentation of the agreement morphemes is supported by agreement patterns in other languages. For example, Mitchell (1994) argues against Agr as a functional head for Finno-Ugric

languages. Yoon (1994) argues against a checking theory where lexical items are inserted fully inflected for Korean verbal inflection which is also consistent with this study. Chapter 1 showed that a lexical item would be selected without case (unless inherent) and this chapter shows that if a lexical item were selected fully inflected the item would have to "look ahead" to see its syntactic relation in the sentence to know what type of agreement to have.

Appendix A

Main Mood Agreement for Subjects and Third Person Objects¹⁴

1. (a) Indicative Mood				(b) Agreement Pattern		
(i)	1E	1dE	1plE	1E	1dE	1plE
3A	va.ra	va.vuk	va.vut	S	S	S
3dA	va.ak.ka	va.a.vuk	va.a.vut	O-S	O-S	O-S
3plA	va.k.ka	va.vuk	va.vut	O-S	S	S
(ii)	2E	2dE	2plE	2E	2dE	2plE
3A	va.it	va.sik	va.si	S	S	S
3dA	va.ak.kik	va.as.sik	va.as.si	O	O-S	O-S
3plA	va.t.it	va.sik	va.si	O-S	S	S
(iii)	3E	3dE	3plE	3E	3dE	3plE
3A	va.nga	va.ngak	va.ngat	S	S	S
3dA	va.a.ngik	va.a.ngik	va.a.ngik	O	O	O
3plA	va.ngit	va.ngik	va.ngit	O	S	O

2. (a) Optative Mood				(b) Agreement Pattern		
(i)	1E	1dE	1plE	1E	1dE	1plE
3A	la.gu	la.vuk	la.vut	O	S	S
3dA	la.ak.ka	la.a.vuk	la.a.vut	O-S	O-S	O-S
3plA	la.k.ka	la.vuk	la.vut	O-S	S	S
(ii)	2E	2dE	2plE	2E	2dE	2plE
3A	guk	ti.k.ku	si.uk	O	S-O	S-O
3dA	k.kik	ti.k.kik	si.k.kik	S-O	S-O	S-O
3plA	k.kit	ti.k.kit	si.git	S-O	S-O	S-O

¹⁴The data for indicative, optative and interrogative moods is taken from Harper 1974: 33-35, 39-41 and 36-38 respectively. For some of the endings Harper provides more than one ending. Since they are quite similar and the difference is not relevant for the discussion in this chapter, I have listed only one form. Under *(b) Agreement Pattern*, if there is any type of agreement (number and/or person) marking for the subject or object, an S or O is marked. For an analysis of third person agreement morphemes in East Greenlandic, see Mennecier and Robbe (1994).

(iii)	3E	3dE	3plE	3E	3dE	3plE
3A	li.uk	li.k.ku	li.dj.uk	0	S-O	S-O
3dA	li.k.kik	li.k.kik	li.k.kik	S-O	S-O	S-O
3plA	li.git	li.k.kit	li.git	0	S-O	0

3. (a) Interrogative Mood

(i)	1E	1dE	1plE
3A	vi.gu	vi.tti.gu	vi.ti.gu
3dA	va.ak.ka	vi.tti.gik	vi.ti.gik
3plA	va.k.ka	vi.tti.git	vi.ti.git

(ii)	2E	2dE	2plE
3A	vi.uk	vi.ttik.ku	vi.si.uk
3dA	vi.gik	vi.ttik.kik	vi.si.gik
3plA	vi.git	vi.ttik.kit	vi.si.git

(iii)	3E	3dE	3plE
3A	va.uk	va.ak	va.dj.uk
3dA	va.k.kik	va.k.kik	va.gik
3plA	va.git	va.k.kit	va.git

(b) Agreement Pattern

1E	1dE	1plE
0	S-O	S-O
O-S	S-O	S-O
O-S	S-O	S-O

3E	2dE	2plE
0	S-O	S-O
0	S-O	S-O
0	S-O	S-O

3E	3dE	3plE
0	S-O	S-O
0	0	0
0	S-O	0

Appendix B

Main Mood Agreement for First and Second Person Subjects and Objects¹⁵

1. (a) Indicative Mood				(b) Agreement Pattern		
(i)	1E	1dE	1plE	1E	1dE	1plE
2A	-va.git	-va.tti.gik	-va.pti.git*	0	S-O	S-O
2dA	-va.s.sik	-va.s.sik	-va.s.sik	0	0	0
2plA	-va.s.si	-va.s.si	-va.p.si*	0	0	S-O
(ii)	2E	2dE	2plE	2E	2dE	2plE
1A	-var.ma	-va.att.nga	-va.psi.nga*	0	S-O	S-O
1dA	-va.tti.guk*	-va.att.guk	-va.tti.guk	0	0	0
1plA	-va.pti.gut*	-va.att.gut	-va.pti.gut*	S-O	S-O	S-O
2. (a) Optative Mood				(b) Agreement Pattern		
(i)	1E	1dE	1plE	1E	1dE	1plE
2A	-la.git	-la.tti.git	-la.tti.git	0	S-O	S-O
2dA	-la.s.sik	-la.s.sik	-la.s.sik	0	0	0
2plA	-la.s.si	-la.s.si	-la.s.si	0	0	0
(ii)	2E	2dE	2plE	2E	2dE	2plE
1A	-ng.nga	-tti.nga	-si.nga	S-O	S-O	S-O
1dA	-ti.guk	-ti.guk	-ti.guk	0	0	0
1plA	-ti.gut	-ti.gut	-ti.gut	0	0	0
3. (a) Interrogative Mood				(b) Agreement Pattern		
(i)	1E	1dE	1plE	1E	1dE	1plE
2A	-va.git	-vi.tti.git	-vi.ti.git	0	S-O	S-O
2dA	-va.s.sik	-va.s.sik	-va.s.sik	0	0	0
2plA	-va.s.si	-va.s.si	-va.s.si	0	0	0
(ii)	2E	2dE	2plE	3E	2dE	2plE
1A	-vi.nga	-vi.tti.nga	-vi.si.nga	0	S-O	S-O
1dA	-vi.tti.guk*	-vi.tti.guk	-vi.tti.guk	0	0	0
1plA	-vi.tti.gut	-vi.tti.gut	-vi.ti.gut	0	S-O	0

¹⁵The data for indicative, optative and interrogative moods is taken from Harper 1974: 33-35, 39-41 and 36-38 respectively. Harper provides more than one ending for those with *. Since they are quite similar and the difference is not relevant for the discussion in this chapter, I have listed only one form.

Chapter 6

Conclusion

There are various descriptive accounts of ergative languages, and for the different dialects of the languages of the Inuit. And there are various explanations for the existence of ergative versus accusative languages. For example, Inuktitut is described as using language particular options for assigning case to objects since ergative languages cannot assign Acc case (Bok-Bennema 1991). Other accounts posit a parameter, and, depending upon the setting, the language will be ergative or accusative. For example, in Johns (1992) the lexical properties are parametrized such that Inuktitut is unable to project a VP. In others the functional heads are parametrized such that there is the same structure for ergative and accusative languages, but different functional heads are active. For example, given the structure $[_{TP} T [_{TrP} TrP [_{VP} NP_S [_{V'} V NP_O]]]]$, in accusative languages T is active while in ergative languages Tr is active (Murasugi 1992a, 1992b). Or in the similar structure $[_{AGR1P} Agr_1 [_{TP} T [_{AGR2P} Agr_2 [_{VP} NP_S [_{V'} V NP_O]]]]]]$, Agr_1 is active in accusative languages while Agr_2 is active in ergative languages (Bobaljik 1993). And still another account does not involve parameters but assigns case to an argument in a structural configuration ("case-binding" configuration) according to universal and language particular case realization conventions (Bittner 1994a, Bittner and Hale 1996). In summary, all of these accounts attribute the difference between ergative and accusative languages to an arbitrary parameter setting or structural configuration, or to language specific properties; and they do not provide a reason for why the parameter might be set one way or the other, in spite of the fact that the conceptual-intentional interface is affected by the case marking on the arguments.

In this study I have presented an account for why a language would be ergative or accusative. I have shown that speaker's intentions to pick out a particular object can account for the difference between ergative languages and accusative languages. In ergative languages the speaker's intentions are checked at Spell-out by an object with specific reference taking wide scope and moving into [Spec, T] with the resultant Nom/Abs case marking. In accusative languages the checking does not occur until after Spell-out, resulting in Acc case marking on the object since it remains inside the VP at Spell-out.

I showed that a speaker's intentions to pick out a particular entity belongs to the semantic component of grammar in that it has quantificational force (Section 2.4.1) and makes a specific reference and presupposes the existence of the object, and it affects the type of questions that can be asked and the truth values of the utterance (cf. Donnellan 1966, 1978). It is neither focus/topic nor theme/rheme.

Importantly, since ergative languages mark speaker intentions at Spell-out the difference in scope readings between specific and non-specific objects is clearly shown. In ergative languages, when specific reference is made to an object, it moves to [Spec, T] at Spell-out so that there is only the wide scope reading, even if the object contains an existential quantifier. If the speaker does not intend to pick out a particular object, the object stays inside the VP with the resultant narrow scope reading; but when the object contains an existential quantifier (variable) the object can take wide scope, so both narrow and wide scope readings are possible for non-specific objects. However, in accusative languages speaker intentions are not checked until after Spell-out, i.e., specificity is checked covertly. Thus specific reference of an object is checked covertly with the resultant wide scope reading; but, since this object is within the VP at Spell-out,

there is also a non-specific (attributive) reading possible. This latter reading becomes more salient when there is an operator in the clause which would take wide scope over the object. By looking at why a language is ergative, I was able to illustrate what is meant by the conceptual-intentional interface and the effect of the interaction of Spell-out and the conceptual-intentional interface. I was also able to show that a feature needing to be checked can be on the item that moves.

I was also able to show why an ergative language would also exhibit "split ergativity". A specific object moves to [Spec, T] where it is assigned Abs/Nom case and takes wide scope; the subject remains inside the VP where it is assigned Erg/Gen case by V. This is the classic ergative-absolutive pattern of ergative languages. A non-specific object stays inside the VP where it is assigned Inst/Acc case by the V; and the subject moves to [Spec, T] where it is assigned Abs/Nom case. This is the nominative-accusative pattern that causes the phenomenon of split ergativity.

By focussing on case marking in Inuktitut, I was able to show that speaker's intentions is a semantic concept termed specificity and is part of the conceptual-intentional interface of language. But Inuktitut is an ergative language that indicates ergativity both in case marking and in agreement. I used already published paradigms and descriptions of verbal agreement patterns in various Inuit languages in Chapter 5. I showed that movement of specific objects at Spell-out determines which arguments have agreement. The PF component determines the pattern of agreement which will depend upon the information supplied at Spell-out about the mood marker, the subject number and person if it is in [Spec, V] or [Spec, T], and the object number and person if it is in [Spec, T]. By focussing on agreement in Chapter 5 I was able to briefly

illustrate the relation between the PF component and Spell-out. In particular, the PF component determines the agreement pattern from the information at Spell-out.

Since this thesis focussed on the North Baffin dialect of Inuktitut there are also contributions to the empirical data about this language. The fieldwork data in Chapter 2 has shown that both Erg/Gen-Abs/Nom and Abs/Nom-Inst/Acc sentences can have all types of NPs as objects, e.g., proper names, modified nouns, demonstratives, quantifiers, and pronouns; and that native speakers interpret Abs/Nom objects as picking out a particular entity. It has also shown that Abs/Nom objects are only interpreted with wide scope, even if an operator is present in the sentence; and that Inst/Acc objects are non-specific but can be interpreted specifically if an operator is present (see Bittner (1987) for West Greenlandic Eskimo). Examples of the types of questions that could be asked with specific and non-specific objects were also given. More complete data is available in Manga (1994a, 1996).

Fieldwork data on the case marking in three types of nominals (nouns, derived nouns, and gerunds) was presented in Chapter 4. Both nouns and derived nouns case mark the adnominals with Gen/Erg; while gerunds case mark the subject with Gen/Erg and the object with Inst/Acc. This is consistent with the case marking pattern established in Chapter 1.

The idea that the object is non-specific (indefinite) in the Abs/Nom-Inst/Acc sentences in ergative languages is generally widely acknowledged. Some examples were cited in Chapter 2. The specific/referential object in Erg/Gen-Abs/Nom sentences is often acknowledged as referential, though this is often described as a discourse property. For example, for Central Alaskan Yupik Eskimo, Woodbury (1985: 282) describes the Abs/Nom object or subject of an embedded clause that has moved to the matrix [Spec, T] as having "such discourse topic

properties as overt agreement in the verb inflection, **(something like) definite reference**, and freedom of movement to a preposed topic position and a postposed position" [boldface mine].

A speaker's intentions to pick out a particular object results in Erg/Gen-Abs/Nom sentences, while Abs/Nom-Inst/Acc sentences are used if no particular referent is picked out. The following two descriptions from the literature illustrate why a speaker might make specific or non-specific reference to an object.

Sentences with specific and non-specific objects are often described with reference to time or aspect. Take, for example, Tarpent's description (1982: 80) of the "active" (i.e., Erg/Gen-Abs/Nom) sentences versus the "antipassive" (i.e., Abs/Nom-Inst/Acc) sentences in the ergative language Nisgha (a Tsimshian language). For the sentences in (1)¹, Tarpent describes the Erg/Gen-Abs/Nom sentence (1a) as "the action described by the verb is construed as attaining a specific goal, the object, which is always expressed. The time element expressed or implied by the verb is also more or less definite."

- (1) a. gibayis Lucy t Mary (Nisgha, Tarpent: eg. (52))
 kʷpá-(y)*-s Lucy t Mary
 wait-Erg-DM Lucy TM Mary
 'Lucy waited for Mary'
- b. gibe'eskw t Lucy as Mary (Nisgha, Tarpent: eg. (53))
 kʷpá-?skʷ t Lucy ?a-s Mary
 wait-AP TM Lucy P-DM-Mary
 'Lucy waited for Mary'

The Abs/Nom-Inst/Acc example (1b) is described as the object being "left undefined; even if it

¹The * is a schwa. The morphological decomposition is given by Tarpent (1982) where she uses the following abbreviations: AP=antipassive, TM=topic marker, DM= "connectives", i.e., phonological affixes connected semantically and grammatically with the following word or phrase, P=preposition.

is expressed in the sentence, it may be indefinite in extent; and even where the object is fully specified, as in the examples above, there is no certainty that the goal of the action will be reached...But if the object is vague in nature or indefinite in extent, the process also takes an indeterminate amount of time and may stretch out indefinitely, in contrast to the more or less predictable or at least definable amount of time required to perform the action in the Active sentence." Comparing the interpretation that Tarpent gives for (1a) and (1b) illustrates how a proper name could be used non-specifically. Sentence (1a) "implies not only that Lucy waited for Mary, but that she fully expected Mary to join her, and that Mary did in fact join her after a reasonable amount of time" while for (1b) "there is no certainty that Mary did join Lucy, or even that Lucy expected her to do so: Lucy might just have been waiting around on the odd chance that Mary might show up."

Bittner (1987: 199) describes an aspectual difference between the specific and non-specific sentences. "For instance, with an accomplishment verb like *tuqut-* 'kill', the transitive form entails that the patient is dead, whereas the *-si*, *-(ss)i*, and *-nnig* antipassives² are compatible with the victim being almost but not quite dead yet." Another example is in (2). When used with a specific object as in (2a), *sana-* 'build' can be interpreted as an activity or as an accomplishment. But when used with non-specific objects as in (2b), *sana-* can only be interpreted as an activity. Bittner (p. 201) considered there to be a null AP in (2b) which is an imperfective aspect marker.

(2) a. Jaaku.p illu taanna sana.vaa (West Greenlandic, Bittner: p. 202)
 Jacob.Erg/Gen house(Abs/Nom) this(Abs/Nom) build.IND3E/3A
 'Jacob built/was/is building this house (may but need not have finished)'

²Bittner (1987) describes the five most common antipassives in West Greenlandic Eskimo as not really antipassives but as aspectual affixes.

- b. Jaaku illu.mik tassuminnga sana.0.vuq
 Jacob(Abs/Nom) house.Inst/Acc this(Inst/Acc) work.AP.IND3A
 'Jacob was/is building this house (has not finished it yet)'

The time and aspectual differences do not cause Erg/Gen-Abs/Nom and Abs/Nom-Inst/Acc sentences. For example, the same aspect can be in both types of sentences as in (3a) where *-tar-* is a frequentive suffix and the object is specific; while in (3b) the frequentive AP suffix can be *-si-*, *-(ss)i-* or *-nnig-* and the object is non-specific.

- (3) a. ullut tamaasa Jaaku maliti.tar.paa (B 1987: p. 199)
 'He followed Jacob every day'

- b. ullut tamaasa Jaaku.mik malis.si.vuq/mali.i.vuq/malin.nip.puq (B 1987: 200)
 'He followed Jacob every day'

Rather, time and aspectual differences are more compatible with, or more salient with, certain types of objects and verbs. Some ergative languages such as Atayal (an Austronesian language, Huang 1994) allow ergative sentences to have non-overt objects as in (4), but, from the description of the meaning, specific reference is made to the object. In (4a) the pronoun *-saku?* 'I' is Nom(Abs) and the prefix *m-* indicates an "intransitive" sentence, while in (4b) *-maku?* 'I' is Gen(Erg) and the suffix *-un* indicates a "transitive" sentence.

- (4) a. m.wah.saku? kira (Atayal, Huang: p. 133)
 'I will come late (I will come to eat or to do something as requested).'

- b. wah.un.maku? kira
 'I will come later (since this route is so important, I will take it later). (This could not be a response to one's invitation to dinner).'

The examples in (1) to (4) have illustrated some reasons why a speaker might make specific or non-specific reference, and have supported the analysis of this study that a speaker's intentions to pick out a particular object being marked at Spell-out can account for ergativity.

This analysis of ergative and accusative languages supports the approach of the Minimalist

Program where (i) agreement is not the head of a functional projection, (ii) feature checking drives movement, (iii) strong features are checked at Spell-out, and (iv) a linguistic expression satisfies the conceptual-intentional (LF) and articulatory-perceptual (PF) interface levels. Importantly it eliminates stipulations from the theory, notably the requirement that features on non-arguments could be checked *in situ* while features on arguments require movement for checking (see Sections 1.4.2 and 1.4.3). It showed that features to be checked can be on the item moved. And it also showed how case is part of the LF level, and, in particular, that lexical items are not selected with structural case (Nom/Abs, Erg/Gen, Inst/Acc); rather structural case is assigned with the case marking on arguments indicating semantic information.

With respect to case theory, my analysis (Section 2.5) supports the position in *Knowledge of Language* that the verbal element is responsible for the Gen case marking on subject arguments in gerunds; rather than the assumption in subsequent analyses that the Gen argument is base generated in [Spec, D].

Various parameters were described and rejected as explanations for a language being ergative or accusative. And my analysis should not be restated in terms of a parameter, for example, in Erg languages [+specific] is a strong feature that is checked at Spell-out while it is weak in Acc languages and checked after Spell-out. In Erg languages an Acc/Inst object can get a specific reading if there is an operator in the clause; while in Acc languages such as Finnish and Hindi there are constructions where the object has Nom case and the subject Erg/Gen case. As noted in Chapter 2, in Acc languages a specific object has a specific/referential/wide-scope reading, but when an operator is present there is also a non-specific/attributive/narrow scope reading possible. For those Acc languages with the Erg/Gen-Nom constructions, the ergative case

marking might be used in those clauses where an operator is present to eliminate the ambiguity and ensure that there is only the specific reading. This thesis addressed the issue as to why a language would have ergative case marking or accusative case marking, and showed that ergative case marking is used if specific objects are checked at Spell-out and accusative if checking is after Spell-out. However, now the question is why do some languages check specific objects at Spell-out while others check afterwards. The answer is not in an arbitrary parameter setting, but perhaps lies in other properties of language.

Bibliography

- Abney, S.P. 1987. *The English Noun Phrase in its Sentential Aspect*. Doctoral dissertation, MIT, Cambridge, Mass.
- Abbott, Barbara. 1993. "A pragmatic account of the definiteness effect in existential sentences" *Journal of Pragmatics* 19: 39-55.
- Abbott, Barbara. 1995. "Some Remarks on Specificity" *Linguistic Inquiry* 26(2): 341-347.
- Ahrens, Kathleen. 1994. "Specificity and Wh-in-situ" *Chicago Linguistics Society* 30(1): 1-15.
- Allen, Sidney W. 1964. "Transitivity and Possession" *Language* 40 (3): 337-343.
- Anderson, Mona. 1983. "Prenominal Genitive NP's" *The Linguistic Review* 3 (2): 1-24.
- Anderson, Stephen. 1972. "On the Syntax of Ergative Languages" in *Proceedings of the Eleventh International Congress of Linguists Aug. 28 - Sept. 2, 1972, Vol. II*, pp. 73-77.
- Anderson, Stephen. 1976. "On the Notion of Subject in Ergative Languages" in Li, ed., *Subject and Topic*. New York: Academic Press, pp. 3-23.
- Anderson, Stephen. 1991. "Syntactically arbitrary inflectional morphology" in Booij and van Marle, eds, *Yearbook of Morphology*. Pp. 5-19.
- Aniyabi, S. 1992. "The Semantics and the Syntax of the Existential *There*-Construction" *Linguistic Analysis* 22: 154-184.
- Baker, Mark C. 1988. *Incorporation*. Chicago: The University of Chicago Press.
- Battistella, Edwin. 1983. "Gerunds and subject case marking" *Proceedings of the West Coast Conference on Formal Linguistics* 2: 1-10.
- Bellert, I. 1977. "On Semantic and Distributional Properties of Sentential Adverbs" *Linguistic Inquiry* 8(2): 337-51.
- Berge, Anna. 1993. "A Review of Reineke Bok-Bennema 'Case and agreement in Inuit'" *Etudes/Inuit/Studies* 17 (2): 141-154.
- Beyer, Stephan V. 1992. *The Classical Tibetan Language*. Albany, N.Y.: State University of New York Press.

- Bittner, Maria. 1987. "On the Semantics of the Greenlandic Antipassive and Related Constructions" *International Journal of American Linguistics* 53 (2): 194-231.
- Bittner, Maria. 1994a. *Case, Scope and Binding*. Studies in Natural Language and Linguistic Theory Vol. 30. Dordrecht: Kluwer Academic Publishers.
- Bittner, Maria. 1994b. "Cross-Linguistic Semantics" *Linguistics and Philosophy* 17 (1): 53-108.
- Bittner, Maria. 1995. "Quantification in Eskimo: A Challenge for Compositional Semantics" in Bach, Jelinek, Kratzer, Partee, eds, *Quantification in Natural Languages*. Dordrecht/Boston/London: Kluwer Academic Publishers.
- Bittner, Maria and Ken Hale. 1995. "Remarks on Definiteness in Warlpiri" in Bach, Jelinek, Kratzer, Partee, eds, *Quantification in Natural Languages*. Dordrecht/Boston/London: Kluwer Academic Publishers.
- Bittner, Maria and Ken Hale. 1996. "The Structural Determination of Case and Agreement" *Linguistic Inquiry* 27 (1): 1-68.
- Blake, Barry J. 1994. *Case*. Cambridge: Cambridge University Press.
- Blevin, Robert S. 1990. "Ergativity and Accusativity in Nisgha Syntax" *Proceedings of the 16th Annual Meeting of the Berkeley Linguistics Society*. Pp. 5-18.
- Bobaljik, Jonathan. 1993. "Ergativity and Ergative Unergatives" in Phillips, ed, *Papers on Case and Agreement II*. MIT Working Papers in Linguistics Vol. 19.
- Bok-Bennema, Reineke. 1991. *Case and Agreement in Inuit*. Studies in Generative Grammar 38. New York: Walter de Gruyter.
- Browning, M.A. and E. Karimi. 1990. *Scrambling in Persian*. Ms. Princeton University, Princeton, N.J.
- Campana, Mark. 1992. *A Movement Theory of Ergativity*. Doctoral dissertation. McGill University.
- Chomsky, Noam. 1973. "Conditions on transformations" in Anderson and Kiparsky, eds, *Festschrift for Morris Halle*. Pp. 232-86.
- Chomsky, Noam. 1986a. *Knowledge of Language: Its Nature, Origin, and Use*. N.Y.: Praeger Publishers.
- Chomsky, Noam. 1986b. *Barriers*. Linguistic Inquiry Monograph Thirteen, Cambridge, MA: The MIT Press.

- Chomsky, Noam. 1989. "Some Notes on Economy of Derivation and Representation" *MIT Working Papers* #10: 43-74.
- Chomsky, Noam. 1992. *A Minimalist Program for Linguistic Theory*. Ms. MIT.
- Chomsky, Noam. 1993. "A Minimalist Program for Linguistic Theory" in Hale and Keyser, eds, *The View from Building 20*. Cambridge: The MIT Press.
- Chomsky, Noam. 1994. *Bare Phrase Structure*. MIT Occasional Papers in Linguistics No. 5.
- Chomsky, Noam. 1995a. "Categories and Transformations" in Chomsky *The Minimalist Program*. Cambridge, Mass./London: The MIT Press.
- Chomsky, Noam. 1995b. *The Minimalist Program*. Cambridge, Mass./London: The MIT Press.
- Chomsky, Noam and Howard Lasnik. 1995. "The Theory of Principles and Parameters" in Chomsky *The Minimalist Program*. Cambridge, Mass./London: The MIT Press.
- Cole, Peter and Gabriella Hermon. 1994. "Is Wh-in-Situ Really in-situ? Evidence from Malay and Chinese" *The Proceedings of the Thirteenth West Coast Conference on Formal Linguistics*. Pp. 189-204.
- Collis, Dirmid R.F., ed. 1990. *Arctic Languages: An Awakening*. Paris: Unesco.
- de Hoop, Helen. 1990. "Restrictions on Existential Sentence and Object-Scrambling: Some Facts from Dutch" in Halpern, ed, *The Proceedings of the Ninth West Coast Conference on Formal Linguistics*. Stanford University. Pp. 277-288.
- de Reuse, Willem J. 1992. "The Role of Internal Syntax in the Historical Morphology of Eskimo" in Mark Aronoff, ed., *Morphology Now*. Albany, N.Y.: State University of New York Press. Pp. 163-178, 212-216.
- de Reuse, Willem Joseph. 1994. *Siberian Yupik Eskimo: The Language and Its Contacts with Chukchi*. Salt Lake City: University of Utah Press.
- Diesing, Molly and Eloise Jelinek. 1993. "The Syntax and Semantics of Object Shift" *Working Papers in Scandinavian Syntax* 51, Department of Scandinavian Linguistics, Lund, Sweden.
- Dixon, R.M.W. 1994. *Ergativity*. Cambridge: Cambridge University Press.
- Donnellan, K.S. 1966. "Reference and Definite Descriptions" *The Philosophical Review* 75(3): 281-304.

- Donnellan, K.S. 1978. "Speaker Reference, Descriptions and Anaphora" in P. Cole, ed., *Syntax and Semantics 9*. New York: Academic Press.
- Dorais, Louis-Jacques. 1978. *Iglulingmiut Uqausingit: The Inuit Languages of Igloolik N.W.T.* Université Laval: Association Inuksiutiit Katimajit.
- Dorais, Louis-Jacques. 1988. *Tukilik: An Inuktitut Grammar for All*. Université Laval: Association Inuksiutiit Katimajit Inc. and Groupes d'Etudes Inuit et Circumpolaires, Inuit Studies occasional papers 2/Cahiers d'Etudes Inuit 2.
- Dorais, Louis-Jacques. 1990. "The Canadian Inuit and their Language" in Collis, ed., *Arctic Languages: An Awakening*. Paris: UNESCO. Pp. 185-289.
- Dryer, Matthew S. 1985. "A Review of Frans Plank, ed. *Ergativity: Towards a Theory of Grammatical Relations*" *The Canadian Journal of Linguistics* 30 (2): 207-212.
- Du Bois, John W. 1987. "The Discourse Basis of Ergativity" *Language* Vol. 63: 805-855.
- Enç, M. 1991. "The Semantics of Specificity" *Linguistic Inquiry* 22(1): 1-25.
- Fabb, N. 1984. *Syntactic Affixation*. Ph.D. dissertation, MIT.
- Fillmore, C.J. 1967. "On the Syntax of Preverbs" *Glossa* 1(2): 91-125.
- Fodor, J.D. and I.A. Sag. 1982. "Referential and Quantificational Indefinites" *Linguistics and Philosophy* 5: 355-398.
- Fortescue, Michael. 1984. *West Greenlandic*. Croom Helm Descriptive Grammars. London: Croom Helm.
- Fortescue, Michael. 1992a. "Morphophonemic Complexity and Typological Stability in Polysynthetic Language Family" *International Journal of American Linguistics* 58 (2): 242-248.
- Fortescue, Michael. 1992b. "The Development of Morphophonemic Complexity in Eskimo Languages" *Acta Linguistica Hafniensia* 25: 5-27.
- Fortescue, Michael. 1993. "Eskimo word order variation and its contact-induced perturbation" *Journal of Linguistics* 29: 267-289.
- Fukui and M. Speas. 1987. "Specifiers and Projections" in MITWPL 8: *Papers in Theoretical Linguistics*, pp. 128-172.

- Giorgi, Alessandra and Giuseppe Longobardi. 1991. *The syntax of Noun Phrases*. Cambridge: Cambridge University Press.
- Grimshaw, Jane and Ralf-Armin Mester. 1985. "Complex Verb Formation in Eskimo" *Natural Language and Linguistic Theory* 3: 1-19.
- Halle, Morris and Alec Marantz. 1994. "Distributed Morphology and the Pieces of Inflection" in Hale and Keyser, eds, *The View from Building 20*. Cambridge, Mass./London: The MIT Press. Pp. 111-176.
- Harper, Ken. 1974. *Some Aspects of the Grammar of the Eskimo Dialects of Cumberland Peninsula and North Baffin Island*. Ottawa: National Museums of Canada, Ethnology Division, Paper No. 15.
- Heim, Irene. 1991. "Articles and Definiteness" in A. v. Stechow and D. Wunderlich, eds, *Semantics. An International Handbook of Contemporary Research*. Berlin: de Gruyter.
- Hellan, L. 1986. "The headedness of NPs in Norwegian" in P. Muysken, H. van Riemsdijk, eds, *Features and projections*. Dordrecht: Foris. Pp. 89-122.
- Hewson, John. 1987. "Are Algonquian Languages Ergative?" in William Cowan, ed., *Papers of the Eighteenth Algonquian Conference*. Ottawa: Carleton University.
- Hewson, John. 1991. "Person hierarchies in Algonkian and Inuktitut" *Linguistics* 29: 861-875.
- Huang, Lillian M. 1994. "Ergativity in Atayal" *Oceanic Linguistics* 33(1): 129-143.
- Iatridou, Sabine. 1993. "On Nominative Case Assignment and a Few Related Things" in Colin Phillips, ed, *Papers on Case and Agreement II*. MIT Working Papers in Linguistics Vol. 19. Pp. 175-196.
- Ioup, G. 1977. "Specificity and the Interpretation of Quantifiers" *Linguistics and Philosophy* 1: 233-245.
- Jäschke, Heinrich August. 1881. *A Tibetan-English Dictionary*. Reprinted London: Routledge and Kegan Paul Ltd. 1949.
- Jenkins, Carolyn J. 1984. "Some Aspects of Word-Formation in a Polysynthetic Language" *Proceedings of the 10th Annual Meeting of the Berkeley Linguistics Society* pp. 104-115.
- Johns, Alana. 1987. *Transitivity and Grammatical Relations in Inuktitut*. Doctoral dissertation. University of Ottawa.
- Johns, Alana. 1992. "Deriving Ergativity" *Linguistic Inquiry* 23: 57-87.

- Johns, Alana. 1993. "Symmetry in Labrador Inuttut" in Bobaljik and Phillips, eds, *Papers on Case and Agreement I*. MIT Working Papers in Linguistics Vol. 18. Pp. 43-57.
- Johnson, Marion R. 1980. *Ergativity in Inuktitut (Eskimo)*, in *Montague Grammar and in Relational Grammar*. Ms., University of Western Ontario, London. Reproduced by the Indiana University Linguistics Club, Bloomington, Indiana.
- Jonas, Dianne and Jonathan Bobaljik. 1993. "Specs for Subjects: The Role of TP in Icelandic" in Bobaljik and Phillips, eds, *Papers on Case and Agreement I*. MIT Working Papers in Linguistics Vol. 18. Pp. 59-98.
- Kalmar, Ivan. 1977. "The Antipassive in Inuktitut" *Etudes/Inuit/Studies* 1 (1): 129-142.
- Kalmar, Ivan. 1979. "The Antipassive and Grammatical Relations in Eskimo" in Plank, ed., *Ergativity: Towards a Theory of Grammatical Relations* Academic Press. Pp. 117-143.
- Kaplan, Lawrence D. 1990. "The Language of the Alaskan Inuit" in Collis, ed., *Arctic Languages: An Awakening*. Paris: UNESCO, pp. 131-158.
- Karimi, Simi. 1989. *Aspects of Persian syntax, specificity, and the theory of grammar*. Doctoral dissertation, University of Washington.
- Karimi, Simi. 1990. "Obliqueness, Specificity, and Discourse functions: Râ in Persian" *Linguistic Analysis* 20 (3/4): 139-191.
- Kennelly, Sarah D. 1991. "Reciprocity in Turkish: Evidence against AGR as a Definition of Finiteness" *The Proceedings of the Tenth West Coast Conference on Formal Linguistics* pp. 269-282.
- King, Tracy Holloway. 1994. "SpecAgrP and Case: Evidence from Georgian" in Harley and Phillips, eds, *The Morphology-Syntax Connection*. MIT Working Papers in Linguistics 22: 91-110.
- Kiss, Katalin E. 1993. "WH-Movement and Specificity" *Natural Language and Linguistic Theory* 11: 85-120.
- Klokeid, Terry J. and Eugene A. Arima. 1977. "Some Generalizations about Antipassives in Inuktitut" *Etudes/Inuit/Studies* 1 (2): 85-95.
- Koopman, Hilda and Dominique Sportiche. 1991. "The position of subjects" *Lingua* 85: 211-258.

- Johns, Alana. 1993. "Symmetry in Labrador Inuttut" in Bobaljik and Phillips, eds, *Papers on Case and Agreement I*. MIT Working Papers in Linguistics Vol. 18. Pp. 43-57.
- Johnson, Marion R. 1980. *Ergativity in Inuktitut (Eskimo)*, in *Montague Grammar and in Relational Grammar*. Ms., University of Western Ontario, London. Reproduced by the Indiana University Linguistics Club, Bloomington, Indiana.
- Jonas, Dianne and Jonathan Bobaljik. 1993. "Specs for Subjects: The Role of TP in Icelandic" in Bobaljik and Phillips, eds, *Papers on Case and Agreement I*. MIT Working Papers in Linguistics Vol. 18. Pp. 59-98.
- Kalmar, Ivan. 1977. "The Antipassive in Inuktitut" *Etudes/Inuit/Studies* 1 (1): 129-142.
- Kalmar, Ivan. 1979. "The Antipassive and Grammatical Relations in Eskimo" in Plank, ed., *Ergativity: Towards a Theory of Grammatical Relations* Academic Press. Pp. 117-143.
- Kaplan, Lawrence D. 1990. "The Language of the Alaskan Inuit" in Collis, ed., *Arctic Languages: An Awakening*. Paris: UNESCO, pp. 131-158.
- Karimi, Simi. 1989. *Aspects of Persian syntax, specificity, and the theory of grammar*. Doctoral dissertation, University of Washington.
- Karimi, Simi. 1990. "Obliqueness, Specificity, and Discourse functions: Râ in Persian" *Linguistic Analysis* 20 (3/4): 139-191.
- Kennelly, Sarah D. 1991. "Reciprocity in Turkish: Evidence against AGR as a Definition of Finiteness" *The Proceedings of the Tenth West Coast Conference on Formal Linguistics* pp. 269-282.
- King, Tracy Holloway. 1994. "SpecAgrP and Case: Evidence from Georgian" in Harley and Phillips, eds, *The Morphology-Syntax Connection*. MIT Working Papers in Linguistics 22: 91-110.
- Kiss, Katalin E. 1993. "WH-Movement and Specificity" *Natural Language and Linguistic Theory* 11: 85-120.
- Klokeid, Terry J. and Eugene A. Arima. 1977. "Some Generalizations about Antipassives in Inuktitut" *Etudes/Inuit/Studies* 1 (2): 85-95.
- Koopman, Hilda and Dominique Sportiche. 1991. "The position of subjects" *Lingua* 85: 211-258.

- Laka, Itziar. 1993. "Unergatives that Assign Ergative, Unaccusatives that Assign Accusative" in Bobaljik and Phillips, eds, *Papers on Case and Agreement I*. MIT Working Papers in Linguistics 18: 149-172.
- Lamontagne, Greg and Lisa Travis. 1987. "The syntax of adjacency" in *Proceedings of the West Coast Conference on Formal Linguistics*, Vol. 6: 173-186. Stanford Linguistics Association.
- Lasnik, Howard. 1993. *Lectures on Minimalist Syntax*. University of Connecticut Working Papers in Linguistics.
- Levin, Beth Carol. 1983. *On the Nature of Ergativity*. Doctoral dissertation, MIT, Cambridge, Mass.
- Libert, Alan Reed. 1992. *On the Distinction between Syntactic and Semantic Case*. Doctoral dissertation, McGill University.
- Lipscomb, David Robert. 1993. "A critique of the nominal hypothesis for Eskimo" *Etudes/Inuit/Studies* 17 (2): 127-140.
- Lobeck, Anne. 1991. "Spec-Head Agreement in DP" in Dawn Bates, ed, *The Proceedings of the Tenth West Coast Conference on Formal Linguistics*. Pp. 297-308.
- Lowe, Ronald. 1985. *Siglit Inuvialuit Uqausiita Ilisarviksait (Basic Siglit Inuvialuit Eskimo Grammar)*. Inuvik, NWT: Committee for Original Peoples Entitlement.
- Mahajan, Anoop. 1990. *The A/A-Bar Distinction and Movement Theory*. Doctoral dissertation, MIT, Cambridge, Mass.
- Mahajan, Anoop. 1992. "The Specificity Condition and the CED" *Linguistic Inquiry* 23(3): 510-516.
- Mahajan, Anoop. 1993. "The Ergativity Parameter: *have-be* alternation, Word Order and Split Ergativity" *The Proceedings of NELS 1993*.
- Mallon, Mick. 1993a. *Introductory Inuktitut Version 2.0*. Victoria: Ittukuluuk Language Programs.
- Mallon, Mick. 1993b. *Introductory Inuktitut: Reference Grammar Version 2.0*. Victoria: Ittukuluuk Language Programs.
- Manga, Louise. 1994a. *Specificity in Inuktitut*. Ms., University of Ottawa.

- Manga, Louise. 1994b. *ERG-ABS for Marking Specificity in Inuktitut*. Paper presented at the 9th Inuit Studies Conference, Iqaluit, June 11-15, 1994.
- Manga, Louise. 1996a. "Specificity in Inuktitut and Syntactic Representation" *Etudes/Inuit/Studies* 20(1).
- Manga, Louise. 1996b. "A Minimalist Account of Accusative vs. Ergative Languages" in *Morphosyntax in Generative Grammar*. Proceedings of the 1996 Seoul International Conference on Generative Grammar. Pp. 345-356.
- Manning, Christopher D. 1994. *Ergativity: Argument Structure and Grammatical Relations*. Doctoral dissertation, Stanford University, California.
- Marantz, Alec. 1995. "The Minimalist Program" in Webelhuth, ed., *Government and Binding Theory and the Minimalist Program*. Oxford, U.K./Cambridge, U.S.A.: Blackwell Limited. Chapter 7, pp. 349-382.
- McGinnis, Martha. 1996. "Two Kinds of Blocking" in *Morphosyntax in Generative Grammar*. Proceedings of the 1996 Seoul International Conference on Generative Grammar. Pp. 357-368.
- Melčuk, I.A. 1980. "Grammatical Subject and the Problem of the Ergative Construction in Lezgian" *International Review of Slavic Linguistics* 5: 231-276.
- Mennecier, Philippe. 1992-93. "Actance et diathèse en *tunumiisut*, dialecte *inuit*" *Modèles linguistiques* 14: 17-46.
- Mennecier, Philippe. 1994. Paper on Actancy Constructions presented at the 9th Inuit Studies Conference, Iqaluit, June 11-15, 1994.
- Mennecier, Philippe et Bernadette Robbe. 1994. "Une troisième personne protéiforme en *inuit*" *Actances* 8: 155-167.
- Menovshchikov, Georgy. 1990. "Contemporary Studies of the Eskimo-Aleut Languages and Dialects: A Progress Report" in Collis, ed., *Arctic Languages: An Awakening*. Paris: UNESCO, pp. 69-76.
- Mey, Jacob. 1969. "Possessive and transitive in Eskimo" *Journal of Linguistics* 6: 47-56.
- Mey, Jacob. 1970. "The Cyclic Character of Eskimo Reflexivization" *Acta Linguistica Hafniensia* 13(1): 1-32.
- Miller, D. Gary. 1993. *Complex Verb Formation*. Amsterdam/Philadelphia: John Benjamins Publishing Company.

- Mitchell, Erika. 1994. "When AgrO is Fused to AgrS: What Morphology Can Tell Us About the Functional Categories" in Harley and Phillips, eds, *The Morphology-Syntax Connection*. MIT Working Papers in Linguistics Vol. 22. Pp. 111-130.
- Miyagawa, Shigeru. 1993. "LF Case-checking and Minimal Link Condition" in Colin Phillips, ed, *Papers on Case and Agreement II*. MIT Working Papers in Linguistics Vol. 19. Pp. 213-254.
- Miyaoka, Osahito. 1984. "On the So-called Half-Transitive Verbs in Eskimo" *Etudes/Inuit/Studies* 8 (Supplementary Issue): 193-218.
- Mohammad, M.A. 1988. "On the Parallelism Between IP and DP" *Proceedings of the Seventh West Coast Conference on Formal Linguistics*. Stanford, CA: Stanford Linguistics Ass.
- Murasugi, Kumiko G. 1992a. *Crossing and Nested Paths: NP Movement in Accusative and Ergative Languages*. Doctoral dissertation, MIT, Cambridge, Mass.
- Murasugi, Kumiko G. 1992b. "Possessive and Transitive Clauses in Inuktitut" in *Proceedings of the 1992 Annual Conference of the Canadian Linguistic Association*. Department of Linguistics, University of Toronto. Pp. 215-226.
- Murasugi, Kumiko G. 1994. "A Constraint on the Feature Specification of Agr" in Harley and Phillips, eds, *The Morphology-Syntax Connection*. MIT Working Papers in Linguistics Vol. 22. Pp. 131-152.
- Murasugi, Kumiko G. 1995. "A Review of Maria Bittner, Case, scope, and binding" *Journal of Linguistics* 31: 157-163.
- Partee, Barbara Hall. 1972. "Opacity, Coreference, and Pronouns" in Davidson and Harman, eds, *Semantics of Natural Language*. Pp. 415-441.
- Pesetsky, David. 1987. "Wh-in-Situ: Movement and Unselective Binding" in Reuland and Meulen, eds, *The Representation of (In)definiteness*. Cambridge, Mass./London: The MIT Press.. Pp. 98-129.
- Petersen, Robert. 1990. "The Greenlandic Language: Its Nature and Situation" in Collis, ed., *Arctic Languages: A N A Wakening*. Paris: UNESCO. Pp. 293-308.
- Potter, Brian. 1995. "Minimalism and the Mirror Principle". Presentation at NELS 26, October 27-29, 1995.
- Pullum, Geoffrey. 1991. "English nominal gerund phrases as noun phrases with verb-phrase heads" *Linguistics* 29: 763-799.

- Reinhart, Tanya. 1987. "Specifier and Operator Binding" in Reuland and Meulen, eds, *The Representation of (In)definiteness*. Cambridge, Mass/London: The MIT Press. Pp. 130-167.
- Reinhart, Tanya. 1994. *Wh-in-situ in the Framework of the Minimalist Program*. Utrecht University: OTS Working Papers.
- Reinhart, Tanya. 1995. *Interface Strategies*. Utrecht University: OTS Working Papers.
- Rischel, Jorgen. 1971. "Some Characteristics of Noun Phrases in West Greenlandic" *Acta Linguistica Hafniensia* 13 (2): 213-216.
- Ritter, Elizabeth. 1991. "Two Functional Categories in Noun Phrases: Evidence from Modern Hebrew" in S.D. Rothstein, ed., *Syntax and Semantics* 25. New York: Academic Press.
- Rivero, Maria Luisa. 1995. "Verb Movement and Economy: Last Resort" *Trondheim Working Papers in Linguistics*. University of Trondheim, Norway. Proceedings of the First Conference on Formal Approaches to South Slavic Languages, Plovdiv, Bulgaria, October 13-15, 1995.
- Rögnvaldsson, E. 1990. "Null Objects in Icelandic" *Syntax and Semantics* 24: 367-379.
- Rude, Noel. 1986. "Topicality, Transitivity, and the Direct Object in Nez Perce" *International Journal of American Linguistics* 52 (2): 124-153.
- Sadock, Jerrold M. 1980. "Noun Incorporation in Greenlandic: A Case of Syntactic Word Formation" *Language* 52 (2): 300-319.
- Sadock, Jerrold M. 1986. "Some Notes on Noun Incorporation" *Language* 62 (1): 19-31.
- Sadock, Jerrold M. 1994. "Syntactic Activity and Inertness in West Greenlandic Derivational Morphology" in Harley and Phillips, eds, *The Morphology-Syntax Connection*. MIT Working Papers in Linguistics Vol. 22. Pp. 217-230.
- Saito, M. 1985. *Some Asymmetries in Japanese and Their Theoretical Implications*. Doctoral dissertation, MIT, Cambridge, Mass.
- Smith, Lawrence R. 1978. "Some Properties of Labrador Inuttut Verbal Derivation" *Etudes/Inuit/Studies* 3 (2): 37-48.
- Smith, Lawrence R. 1979. "Incorporation as a Cyclic Process in Labrador Inuttut" *Etudes/Inuit/Studies* 3 (2): 85-101.

- Smith, Lawrence R. 1980. "Some Categories and Processes of Labrador Inuttut Word Formation" *International Journal of American Linguistics* 46 (4): 279-288.
- Smith, Lawrence R. 1984. "On the Nonergativity and Intransitivity of Relative Clauses in Labrador Inuttut" *Syntax and Semantics* 16: The Syntax of Native American Languages.
- Spalding, Alex. 1992. *Inuktitut: A Grammar of North Baffin Dialects Vol. I and Vol. II*. Winnipeg: Wuerz Publishing Ltd.
- Speas, Margaret. 1991. "Functional Heads and Inflectional Morphemes" *The Linguistic Review* Vol. 8: 389-417.
- Spencer, Andrew. 1992. "Nominal inflection and the nature of functional categories" *Journal of Linguistics* Vol. 28: 313-341.
- Sproat, Richard. 1992. "Morphological non-separation revisited: a review of R. Lieber's Deconstructing Morphology" in Booij and van Marle, eds, *Yearbook of Morphology*. Pp. 235-258.
- Tanaka, Shichiro. 1993. "Case-Checking as Noun Incorporation" *Linguistic Analysis* 23 (3-4): 274-322.
- Taraldsen, Knut Tarald. 1991. "Two arguments for functional heads" *Lingua* 84: 85-108.
- Tarpent, Marie-Lucie. 1982. "Ergative and Accusative: A Single Representation of Grammatical Relations with Evidence from Nisgha" *Working Papers of the Linguistics Circle of the University of Victoria* Vol. 2 (1): 50-106.
- Ulving, Tor. 1987. "The Eskimo Suffixes -a and -i: Markers of What?" *International Journal of American Linguistics* 53(1): 39-60.
- Van Riemsdijk, Henk and Edwin Williams. 1986. *Introduction to the Theory of Grammar*. Cambridge, Mass.: The MIT Press.
- Van Geenhoven, Veerle. July 1996. *Semantic Incorporation and Indefinite Descriptions: Semantic and Syntactic Aspects of Noun Incorporation in West Greenlandic*. Tübingen: Seminar für Sprachwissenschaft Report -03-96.
- Vaxtin, N.B. 1979. "Nominal and Verbal Ergativity in Asiatic Eskimo: Splits in the person and mood paradigms" in Plank, ed., *Ergativity: Towards a Theory of Grammatical Relations*. Academic Press. Pp. 279-289.
- Watai, Fumi. 1996. "One Aspect of Cree Syntax" *Calgary Working Papers in Linguistics* 18 (Winter): 77-101.

- Waite, Jeffrey. 1994. "Determiner phrases in Maori" *Te Reo* 37: 55-70.
- Webelhuth, Gert. 1995. "X-Bar Theory and Case Theory" in Webelhuth, ed., *Government and Binding Theory and the Minimalist Program*. Oxford, U.K./Cambridge, U.S.A.: Blackwell Limited. Chapter 1, pp. 15-95.
- Woodbury, Anthony C. 1977. "The Greenlandic Verbal Suffix -ut-: Interactions of Linguistic Form and Grammatical Function: *Proceedings of the 3rd Annual Meeting of the Berkeley Linguistics Society* pp. 251-269.
- Woodbury, Anthony C. 1984. "Eskimo and Aleut Languages" in Damas, ed., *Arctic in the Handbook of North American Indians* series, ed. W. Sturtevant. Pp. 49-64.
- Woodbury, Anthony C. 1985. "Noun phrase, nominal sentence, and clause in Central Alaskan Yupik Eskimo" in Nichols and Woodbury, eds, *Grammar Inside and Outside the Clause*. Cambridge: Cambridge University Press pp. 61-88.
- Woodbury, Anthony C. 1985. "Marginal Agent Clauses in Central Alaskan Yupik Eskimo Internal and External Syntax" *Chicago Linguistic Society* 21, Part 2: 271-192.
- Woodbury, Anthony C. and Jerrold M. Sadock. 1986. "Affixal Verbs in Syntax: A Reply to Grimshaw and Mester" *Natural Language and Linguistic Theory* 4: 229-244.
- Yoon, James Hye Suk. 1994. "Korean Verbal Inflection and Checking Theory" in Harley and Phillips, eds, *The Morphology-Syntax Connection*. MIT Working Papers in Linguistics, Vol. 22, pp. 251-270.
- Yoon, James Hye Suk. 1996a. "English Nominal Gerund Phrases as phrasal zero derivations" *Linguistics* 34: 3329-356.
- Yoon, James Hye Suk. 1996b. "A Syntactic Account of Category-Changing Phrasal Morphology: Nominalizations in English and Korean" in *Morphosyntax in Generative Grammar*. Proceedings of the 1996 Seoul International Conference on Generative Grammar. Pp. 63-86.
- Zager, David. 1980. "The Protean Changes of Pronoun Markers on Eskimo Verbs" *Papers from the Parasession on Pronouns and Anaphora*. Chicago: Chicago Linguistic Society. Pp. 287-294.